

Introduction to Wireless Sensor Networks

Wendi Heinzelman
Electrical and Computer Engineering

Topics Include...

- Description of wireless sensor networks (WSNs)
- Example applications
- Unique features
- Key metrics for evaluation
- Research opportunities

Wireless Sensor Networks

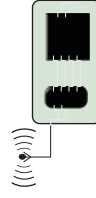

- Participants in “traditional” networks
 - Devices close to a human user
 - Interact with humans
- Alternative concept
 - Focus on interacting with environment
 - Network is *embedded* in environment
 - Nodes in the network are equipped with sensing and actuation to measure/influence environment
 - Nodes process and communicate information

Wireless sensor networks (WSN)
Wireless sensor & actuator networks (WSAN)

Wireless Sensor Nodes

- Sensors monitor environment
 - Cameras, microphones, physiological, pressure, biological sensors, etc.
 - Sensor data limited in range and accuracy
- Micro-sensors
 - Sensor module (e.g., acoustic, image)
 - Digital processor for signal processing and network protocol functions
 - Radio for communication
 - Battery-operated



Wireless Sensor Networks

Networks of distributed data sources that provide information about environmental phenomena to an end user or multiple end users

- Tens to thousands of nodes scattered throughout an environment
- Data routed via other sensors to
 - One or more sinks or base stations
 - Other sensors
- Unique characteristics
 - Ad hoc network
 - No end-to-end communication
 - Co-operative operation
 - Redundancy in information

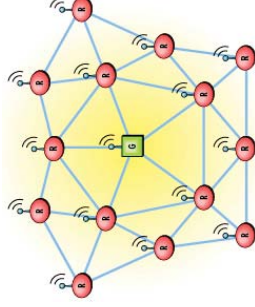

WSN Advantages

- Networking sensors enables
 - Extended range of sensing → improved quality
 - Fault tolerance due to redundancy in data from different sensors
 - Distributed processing of large amounts of data
 - Duty-cycling individual nodes
 - Scalability: quality can be traded for system lifetime
 - Collaboration: nodes can help each perform a larger sensing task
- New wireless networking paradigm
 - Requires autonomous operation
 - Highly dynamic environments
 - Sensor nodes added/fail
 - Events in the environment
 - Distributed computation and communication protocols required



Roles of Nodes in WSNs

- Sources
 - Measure data, report “somewhere”
 - Equip nodes with different kinds of actual sensors
- Sinks
 - Interested in receiving data from WSN
 - May be part of the WSN or external entity
- Actuators
 - Control some device based on data
- Routers
 - Forward data for other nodes

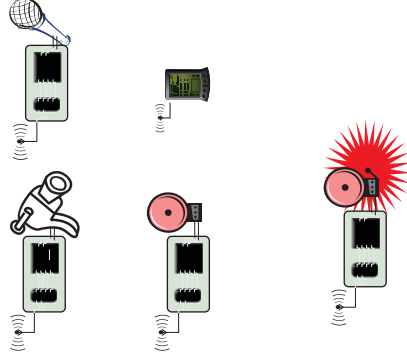

Sensor and Sink Options

- Data sink
 - Embedded within network
 - Located on network edge or outside network
 - Mobile access point
 - One or several sinks
- Sensor mobility
 - Often stationary sensors, especially for large-scale networks
 - Some uses for mobile sensors
 - ZebraNet
 - Military operations
 - Self-propelled sensors
 - Robots
 - Medical monitoring



Source: http://www.ece.gatech.edu/research/labs/bwm/WMSN/testbed_files/robot_vision_testbed.JPG



Source: <http://aicp.ece.utk.edu/research/mobilesensor/mobilesensor-three1.JPG>



WSN Application Types

- Interaction patterns between sources/sinks classify application types
- Event detection
 - Nodes locally detect events (maybe jointly with nearby neighbors)
 - Report these events to interested sinks
 - Event classification additional option
- Periodic measurement
- Function approximation
 - Use sensor network to approximate a function of space and/or time
 - E.g., temperature map
- Edge detection
 - Find edges (or other structures) in such a function
- Tracking
 - Determine position of an observed intruder

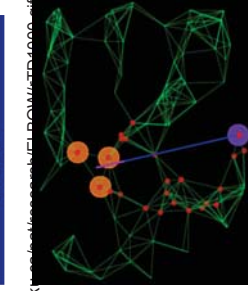
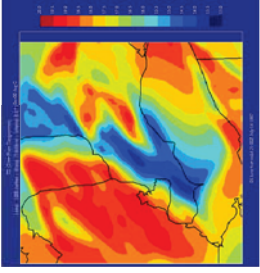

Source: http://www.york.ac.uk/infocentre/news_story.php?id=20060413

Source: <http://publications.csail.mit.edu/abstracts/abstracts07/abstracts/tracking.php>

Environmental Monitoring

- Raw sensor data or high level descriptions about environmental phenomena
- Example projects
 - Ecology of rare plants in Hawaii
 - ZebraNet



Sample Applications

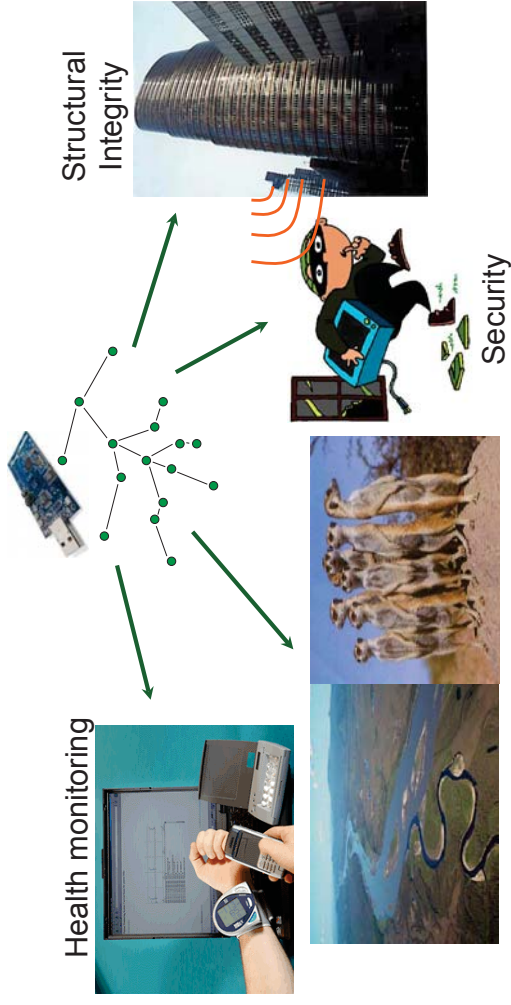

Health monitoring



Environment Monitoring



Security

Structural Integrity



Health Monitoring

- Sensors monitor vital signs
 - Blood pressure, heart rate, EKG, blood O2
- Sense, process, understand, control
- Requires protocols that are
 - Reliable, flexible, scalable, secure

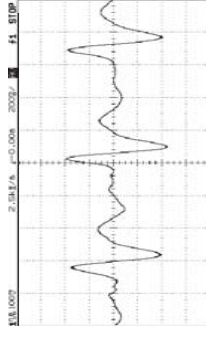

Precision Agriculture

- Deliver fertilizer/pesticides/irrigation only where needed
- Grape Networks
 - California-based company: WSN covers 50 acres, > 200 sensors
 - WSN broadcasts
 - Location of the sensors
 - Temperature, humidity, light
 - Powdery mildew
 - Degree days
 - Sensors buried next to grapes
 - Can view data over web
 - Can set thresholds for automatic alerts
- Many similar projects on monitoring vineyards

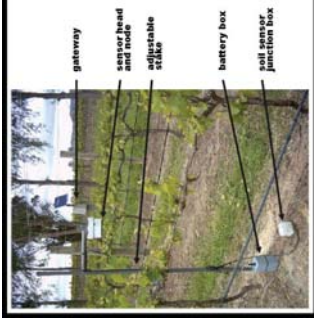

Source:
http://blog.xbow.com/photos/uncategorized/2007/10/18/nodedeployment_2.jpg

Other Applications

- Disaster relief operations
 - Deploy sensors in area hit by disaster (fire, earth quake, etc.)
 - Derive a “map” of safe/dangerous areas within building, grounds, etc.
- Intelligent buildings (or bridges)
 - Reduce energy waste by proper HVAC control
 - Predict structure failures



Source:
http://www.disasterlogistics.org/assets/images/Turkey_Earthquake_103.jpg



Source: <http://ds.informatik.rwth-aachen.de/teaching/ws0607/habsn>



Other Applications

- Facility management
 - Intrusion detection into industrial sites
 - Control of leaks in chemical plants
- Machine surveillance and preventive maintenance
 - Monitor machines for signs of wear and tear
 - Create automatic alerts



Source:
<http://www.merl.com/projects/images/zip/eeipm.jpg>



Source:
<http://www.vafmechanical.com/400ch210.jpg>

Logistics

- Equip goods (parcels, containers) with sensors
- Track whereabouts – total asset management
- Note: passive readout might suffice –RFIDs

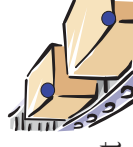

Vehicular sensor networks

- Provide better traffic control by obtaining finer-grained information about traffic conditions
- Intelligent roadside
- Cars as sensor nodes

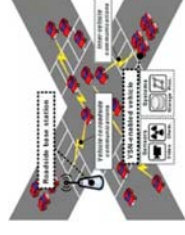

Source:
http://blog.wired.com/photos/uncategorized/2007/06/09/vehicular_sensor_networks.jpg



WSN Limitations

- WSNs extremely resource-limited
 - Goal is to control use of resources while maintaining application's required quality of service (QoS)
 - Limited in bandwidth, energy, computational power, memory
- Communication
 - Bandwidth is limited and must be shared among all the nodes in the sensor network
 - Spatial reuse essential
 - Efficient local use of bandwidth needed
 - Application should influence data sent in a network
 - TCP assumptions of fair-share of bandwidth no longer valid

WSN Limitations (cont.)

- Sensor energy
 - Each sensor node has limited energy supply
 - Nodes may not be rechargeable
 - Eventually nodes may be self-powered
 - Energy consumption in sensing, data processing, and communication
 - Communication often the most energy-intensive
 - For some sensors (e.g., imagers), sensing may also be energy-intensive
 - Must use energy-conserving protocols

Sensor Node Current Draw

Current draw of node subsystems for Tmote Sky

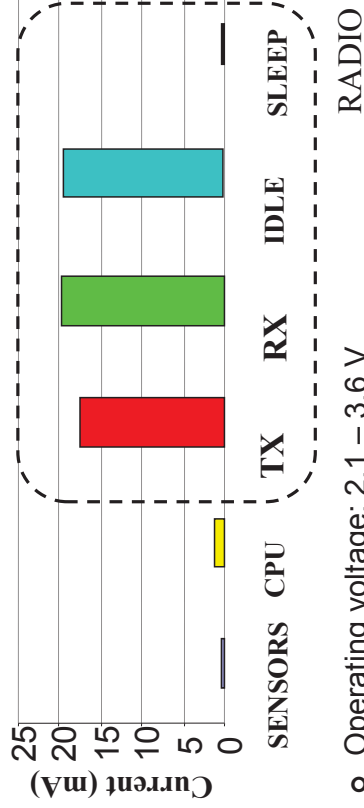

WSN Limitations (cont.)

- Sensor device
 - Computation: many sensors use simple processors → cannot handle complex signal processing or protocol operations
 - Memory: many sensors have small memory → code must be efficient, intelligent storage protocols needed for data storage
 - Buffers: limited memory implies small buffers → need intelligent buffer management to ensure important data not lost due to overflow

WSNs vs. MANETS

General Ad Hoc Networks	Sensor Networks
Unreliable communication	Unreliable communication
Require self-configuration	Require self-configuration
Constrained energy and bandwidth	Very constrained energy and bandwidth
Small-scale	Large-scale
Typically mobile	Typically immobile
Competitive	Cooperative
One-to-one traffic pattern	Many-to-one traffic pattern
Address-centric	Data-centric
QoS: delay, packet drop threshold, etc	Application-specific QoS



Evaluating WSNs

- What are the performance metrics for WSNs?
- System lifetime
 - How to define lifetime? Application-specific, each application will have its own definition of when network stops supporting application
 - E.g., time until network partition
 - E.g., time until probability of missed detection exceeds a threshold
- Quality of result of sensor network
 - Application-specific measure
 - Latency of data transfer
 - SNR of aggregate data signal
 - Probability of missed detection or false alarm
 - Coverage probability
 - Tracking accuracy

Evaluating WSNs (cont.)

- Fault tolerance/reliability
 - Network should be robust to individual node failures
 - Failures due to running out of energy, hardware failures, malicious intercept of sensor, etc.
- Scalability
 - Protocols must scale to thousands or millions of sensor nodes
 - Requires intelligent management of high densities of nodes
- Security
 - Especially important in some sensitive applications
- Cost
 - Goal is to provide long-lasting networks that support QoS for low cost!



Evaluating WSNs (cont.)

- Tradeoffs can be made among these parameters
 - Can reduce quality of result of sensor network to increase system lifetime
 - Can increase security (uses more energy) at the expense of a shorter system lifetime or lower quality sensing results
 - Can support scalability by adding higher cost sensor nodes (e.g., with longer range for transmitting data out of the WSN)
- Important to understand application goals
 - Design decisions should be made accordingly



Some History...

- Networking sensors dates back to 1970's
 - Small scale systems
 - Large, expensive, power-hungry sensors
 - Wired implementations
 - Uses: primarily machine monitoring
- Research into current-day large-scale, low-power wireless sensor networks began in mid-90's, exploded in early 2000's
- Evolved from advances in several areas
 - Radio/communication efficiency
 - Mobile ad hoc networking
 - Embedded computing/pervasive computing
 - MEMS devices (sensors)
 - Low-power hardware design (VLSI)
 - Data mining
 - Distributed detection and distributed signal processing
- Crossroads led to WSNs

Some Early Projects

- DARPA ISAT (Information Science and Technology) study 1997-1998 – primary driver for research on WSNs in US
- WINS project
 - UCLA and Rockwell Science Center
 - Focus on developing low-power electronics
 - Some of the first wireless sensor devices
- μAMPS project
 - MIT
 - Focus on developing low power sensor nodes, signal processing algorithms and networking capabilities for large-scale systems
- TinyOS, motes, etc.
 - Berkeley
 - Developed commercial hardware (“motes”), open-source software for running motes (TinyOS)
 - Easily programmable, full function devices – enabled much research and implementation with real systems



Current Projects

- Too numerous to list!
- Literally thousands of research projects devoted to all aspects of WSN design
 - Hardware
 - Software
 - Networking
 - Signal processing
 - Data analysis
 - Etc., etc.
- Hundreds of commercial applications
 - Precision agriculture
 - Weather monitoring
 - Health monitoring
 - Machine/structure monitoring
 - Security and surveillance
 - Logistics control
 - Military applications

Sensor Motes Timeline

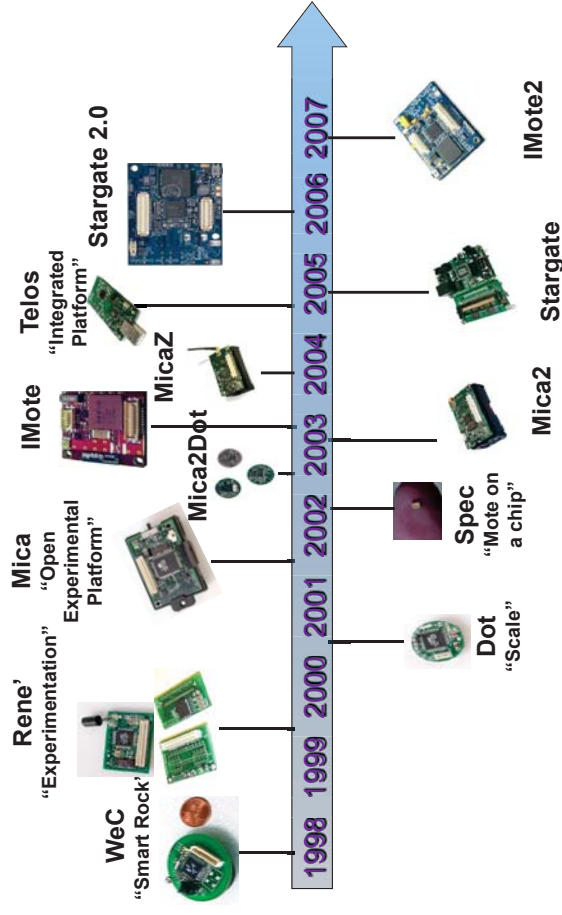

Source: D. Pompili, "Wireless Sensor Networks: Introduction and Applications"



Popular Sensor Platforms



Crossbow MICAZ
<http://www.xbow.com>



Sentilla Tmote Sky
<http://www.sentilla.com>



Crossbow/Intel Imote2
<http://www.xbow.com>



Arduino UNO
<http://www.adafruit.com/>



Ember EM250
<http://www.ember.com>



Traditional Protocol Stack

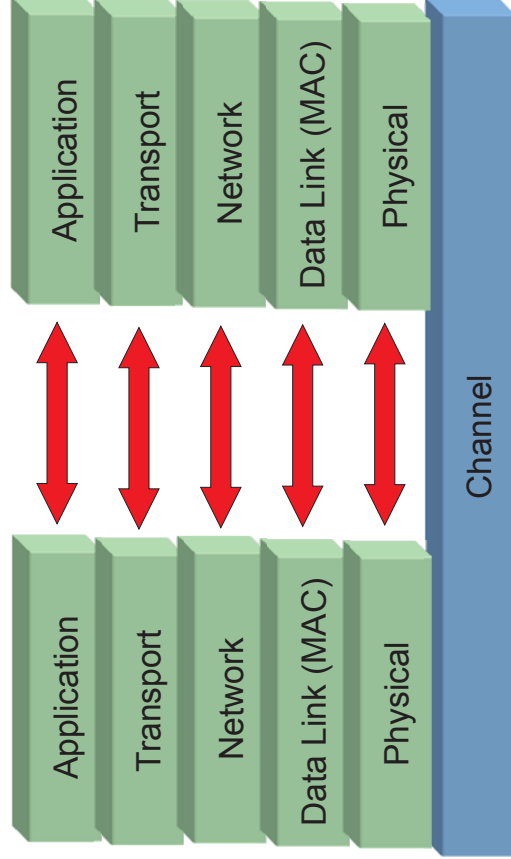

Current State-of-the-Art in Sensor Networking

- Thousands of different protocols for WSNs
- 10 top-tier conferences dedicated entirely to WSN research
 - Additional 10 or so workshops
 - Many networking and communications conference also feature tracks or special sessions on WSNs
 - 1 journal dedicated to WSN research, several others often feature WSN research
- What makes wireless sensor networking so unique?



Example Layered Stack

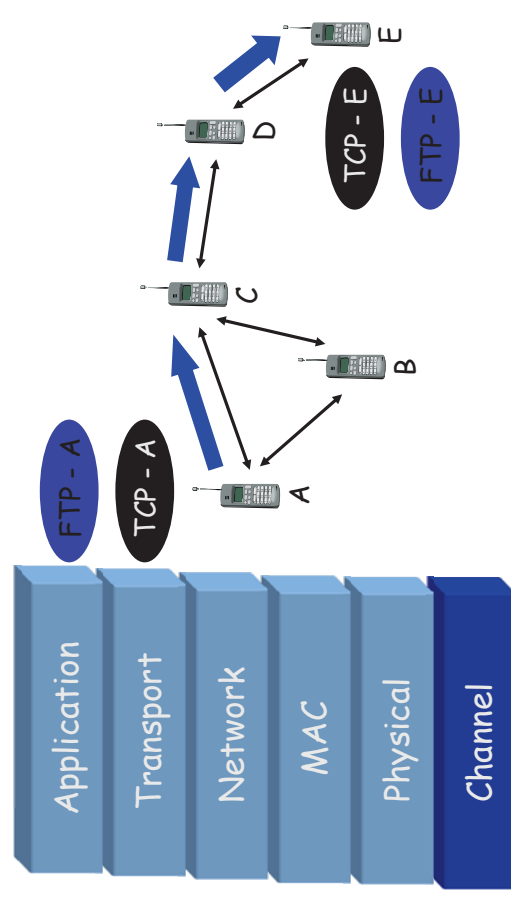

Layered Stacks (cont.)

- Functions at each layer performed independently
 - Cannot optimize at a system level
 - Cannot easily exchange information among different protocol levels
- Trade-off
 - + Ease of use
 - + Flexibility
 - + Standardization
 - Cannot optimize
 - Difficult to share information
- Alternative: cross-layer stacks



WSN Architectures

- Several different architectures proposed for WSNs
- Traditional layered architecture
 - Benefits from modularity and existing protocols
- Cross-layer architectures
 - Provide improved QoS and longer lifetime
- Sensor network architecture (SNA)
 - Provides link layer and hardware platform abstractions
- Information-sharing architecture
 - Provides layered protocols with ability to share information for cross-layer optimizations
- X-Lisa and Universal Protocol Stack (UPS)



Cross-layer Designs

- Two or more layers cooperate to improve network's response
 - Layer fusion: operations from two or more layers performed jointly
 - Information sharing: several layers share information
- No standardized architecture

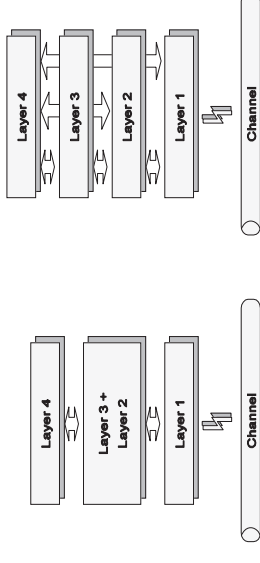

Layer fusion stack Information-sharing stack



Design Issues— MAC

- Cooperative nature of sensor networks
 - Fairness not an issue
 - Sensors should not compete for limited bandwidth
- Exploit traffic patterns
- Energy efficiency extremely important
 - Reduce idle listening
 - Reduce unnecessary reception
- Example protocols
 - Scheduled: TDMA protocols, LEACH
 - Contention-based: S-MAC, T-MAC, DMAC, TRAMA, STEM
 - Low-power listening: B-MAC, X-MAC, STEM, C-MAC

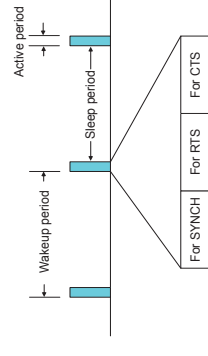

Design Issues— Routing

- Different traffic models
- Data dissemination rather than P2P routing
- Data-centric rather than address-centric
- Location-aware sensors
- Resource-aware routing needed
- Exploit local aggregation
- Time-varying channels leads to necessity for dynamic routing approaches
- Types of routing in WSNs
 - Resource-aware routing
 - Data-centric routing
 - Geographic routing
 - Clustering

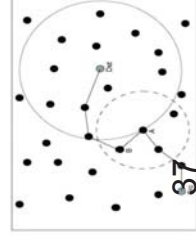
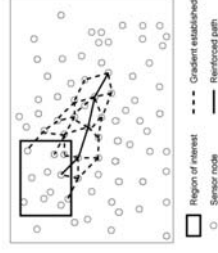
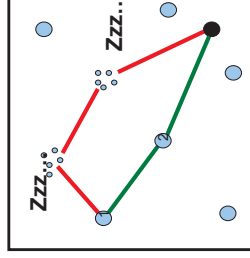

Design Issues— QoS Management

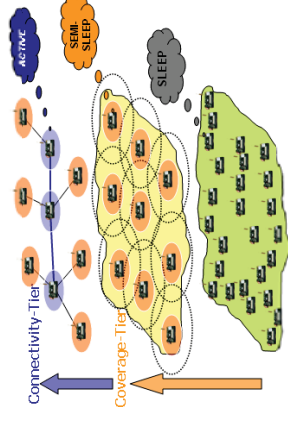

- QoS determined by content of data rather than amount
- Transport layer
 - Intelligent congestion management
 - Throttle back irrelevant data rather than each node's sending rate
- Sensor selection
 - Ensure the correct sensors provide data
 - E.g., coverage: each location monitored by at least K sensors



Design Issues— Services

- Localization
 - Needed to determine where events occur
 - Often times, only relative position is necessary
- Time synchronization
 - Needed to determine if event sensed by two sensors is in fact the same event
 - Needed to determine object speed
- Security
 - Should be thought about from the inception of the network
 - Use scalable and application-specific security to ensure "the right" data protected

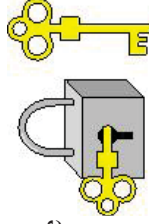
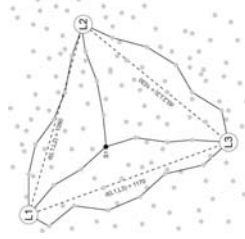

Need for Further WSN Research

- With all the advances in sensor networks from the hardware to the protocols to the algorithms, it is in some ways surprising that sensor networks are still not mainstream (like the Internet, cell phones, WiFi, etc.)
- Implies much research still needed!
- Sensor networks need to become
 - Easier to set up
 - Easier to maintain
 - Longer lifetimes
 - Greater flexibility
 - Connection to other networks
 - Cheaper



Research Issues 1

- Appropriate QoS model
 - Traditional networks: delay, packet delivery ratio, jitter
 - Sensor networks: probability of missed detection of an event, signal-to-noise ratio, network sensing coverage, others
 - Difficult to translate these data-specific QoS parameters into meaningful protocol parameters
 - What are good QoS parameters and how can these be described efficiently for use in protocol optimizations?



Research Issues 2

- Appropriate architecture
 - Cross-layer
 - Entire protocol stack tailored to specific needs of WSN application
 - Trade-off: generality and ease of network design to achieve lifetime increases
 - Layered
 - Generality leads to worse system performance
 - Hybrid approaches
 - What is best architecture to meet WSN needs?



Research Issues 3

- Adaptability
 - Rather than design new protocols and algorithms for every new application, much better to allow protocols and algorithms to *adapt* as application QoS goals change
 - Requires cross-layer information exchange
 - Requires new ways of thinking about (and designing!) protocols and algorithms
 - Automation of translation of QoS goals into protocol parameters → applications for WSNs will become much easier to design!



Research Issues 4

- Reliability
 - Links and sensors may fail, temporarily or permanently
 - Must design protocols to provide reliable service with these failures
 - How can reliability be achieved at all levels of the protocol stack?
- Self-powered systems
 - Using vibration, solar, heat
 - How should protocols be modified for time-varying energy capacities?



Research Issues 5

- Heterogeneous applications
 - Sensor nodes may be shared by multiple applications with differing goals
 - How to ensure protocols efficiently serve multiple applications simultaneously?
- Heterogeneous sensors
 - How to make best use of resources in heterogeneous sensor networks?



Research Issues 6

- Security
 - How much and what type of security is really needed?
 - How can data be authenticated?
 - How can misbehaving nodes be prevented from providing false data?
 - Can energy and security be traded-off such that the level of network security can be easily adapted?



Research Issues 7

- Actuation
 - Eventually sensor networks will “close the loop”
 - Data do not need to reach base station
 - Current models for sensor networks may not be valid— what new models are needed?
- Distributed and collaborative data processing
 - How to best process heterogeneous data?
 - How much data and what type of data should be processed to meet application QoS goals while minimizing energy drain?



Research Issues 8

- Challenged environments
 - Underground sensor networks
 - Agriculture monitoring
 - Structural monitoring
 - Underwater sensor networks
 - Tsunami warnings
 - Ocean monitoring
 - What changes do these channels pose for existing protocols and algorithms?
 - What architectures should be used?



Research Issues 9

- Integration with other networks
 - Sensor networks may interface with other networks, such as a WiFi network, a cellular network, or the Internet
 - What is the best way to interface these networks?
 - Should the sensor network protocols support (or at least not compete with) the protocols of the other networks?
 - Or should the sensors have dual network interface capabilities?
 - What about IP-based sensors?

Research Issues 10

- “Participatory Sensing”
 - Use sensors on cell phones
 - How to design systems to engage users?
 - How to design reliable systems when there is no control over the sensed data or participation?
 - How to collaborate when sensors are not under one’s control?

Wireless Communications and Networking Group @ UR

- Mobile Ad Hoc Networks
 - Cross-layer architectures
 - Quality of Service (QoS)
- Wireless Sensor Networks
 - Wake-up radios
 - Sleep management
 - Protocols and architectures
- RFID Networks
 - MAC protocols
 - RFID-Sensor networks
- Mobile-Cloud Computing
- Self-powered Field Systems
 - Emotion Detection from Speech
 - Protein Structure Prediction

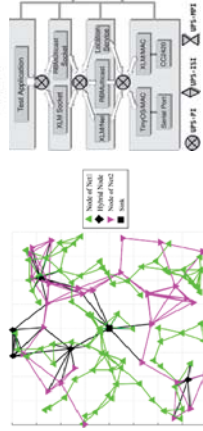
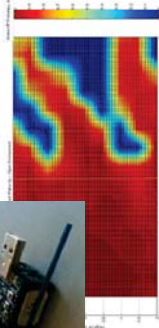

Questions?

Contact Information:

Wendi Heinzelman

wheinzel@ece.rochester.edu

<http://www.ece.rochester.edu/~wheinzel>