

# **CSC 252: Computer Organization**

## **Fall 2021: Lecture 16**

The Storage Hierarchy

Instructor: Alan Beadle

Department of Computer Science  
University of Rochester

# Announcements

Midterm grades are online

# Midterm Results

- 41 took the exam in person, 1 remotely
- Highest grade: 79 / 75 (105.3%)
- Lowest grade: 18.55 / 75 (24.73%)
- Average: 55.2 / 75 (73.7%)
- Median: 53.75 / 75 (71.6%)

# Midterm Results

(Shown as percentages)

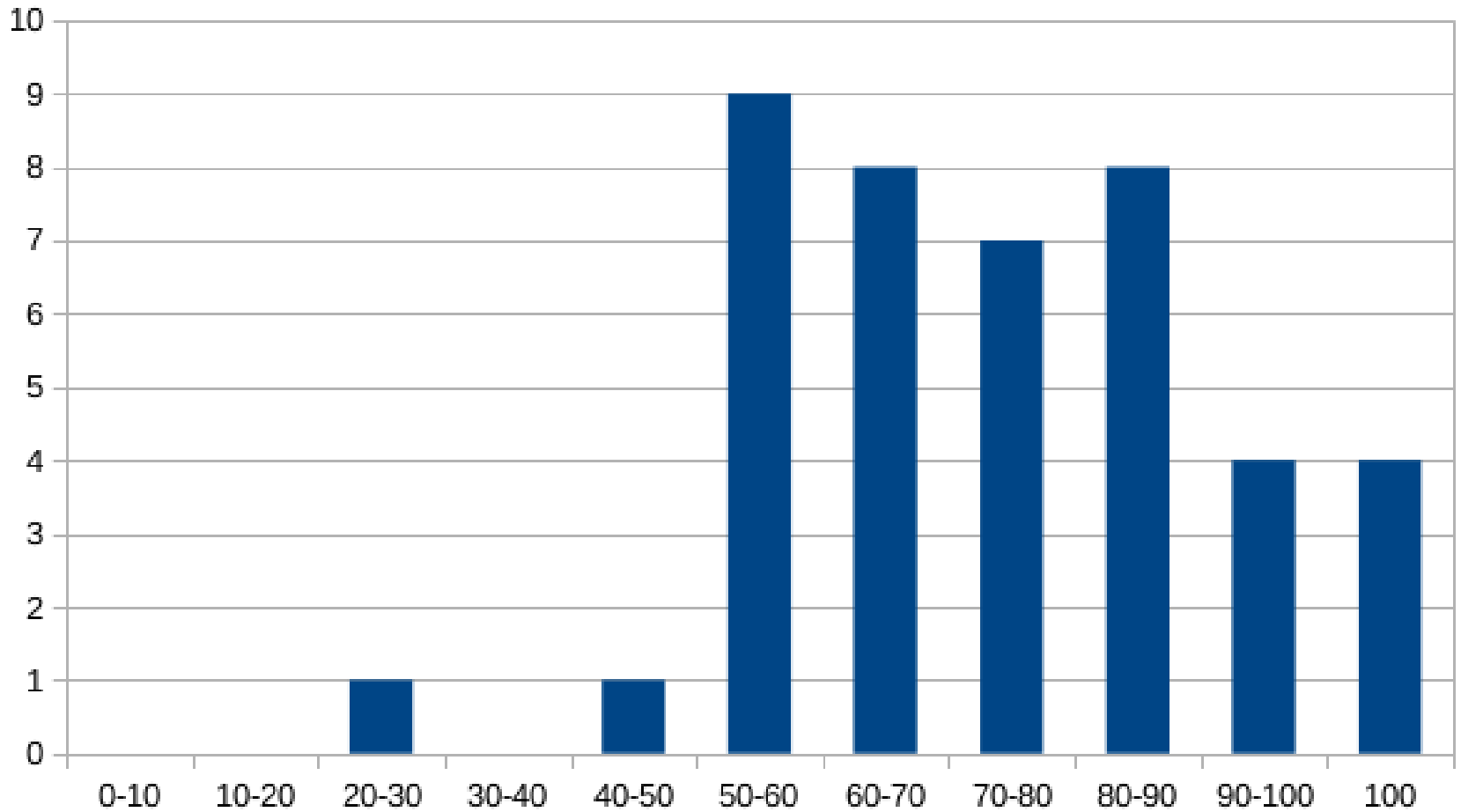

# Course Grading Summary

Recall:

5 assignments (40%, or 8% each)

1 midterm (25%)

1 final (35%)

Your final grade will be computed as a percentage using the weights above

# Course Grading Summary

Recall:

5 assignments (40%, or 8% each)

1 midterm (25%)

1 final (35%)

Your final grade will be computed as a percentage using the weights above

At the end of the semester I will apply a letter grading schema to that percentage

# Course Grading Summary

Recall:

5 assignments (40%, or 8% each)

1 midterm (25%)

1 final (35%)

Your final grade will be computed as a percentage using the weights above

At the end of the semester I will apply a letter grading schema to that percentage

This will be based on my assessment of how each grade range has or has not achieved the goals of the course. Essentially a “curve”.

# So what does my score mean?

- Depends on how you are doing on the assignments. Let's assume you have been doing the assignments.



# So what does my score mean?

- Depends on how you are doing on the assignments. Let's assume you have been doing the assignments.
- If you got better than 90% on the midterm and have been doing the assignments, you are probably on track for an A.

# So what does my score mean?

- Depends on how you are doing on the assignments. Let's assume you have been doing the assignments.
- If you got better than 90% on the midterm and have been doing the assignments, you are probably on track for an A.
- If you got better than the median (71.6%) then you are on track for a decent passing grade (B-range)

# So what does my score mean?

- Depends on how you are doing on the assignments. Let's assume you have been doing the assignments.
- If you got better than 90% on the midterm and have been doing the assignments, you are probably on track for an A.
- If you got better than the median (71.6%) then you are on track for a decent passing grade (B-range)
- If you got less than ~65% then you should work much harder to get better than a C

# So what does my score mean?

- Depends on how you are doing on the assignments. Let's assume you have been doing the assignments.
- If you got better than 90% on the midterm and have been doing the assignments, you are probably on track for an A.
- If you got better than the median (71.6%) then you are on track for a decent passing grade (B-range)
- If you got less than ~65% then you should work much harder to get better than a C
- If you got less than 55% then you should be very concerned about passing, especially if you have not been doing the assignments

# When do I get my exam back?

- TBD
- Some people are taking it next week due to exceptional circumstances
- While that exam will be a modified form, I still don't want to risk any dishonesty or unfair advantage

# When do I get my exam back?

- TBD
- Some people are taking it next week due to exceptional circumstances
- While that exam will be a modified form, I still don't want to risk any dishonesty or unfair advantage
- Solutions will be uploaded after no more people need to take it
- But you can come look at it in my office (Fri 12-2 this week)

# When do I get my exam back?

- TBD
- Some people are taking it next week due to exceptional circumstances
- While that exam will be a modified form, I still don't want to risk any dishonesty or unfair advantage
- Solutions will be uploaded after no more people need to take it
- But you can come look at it in my office (Fri 12-2 this week)
- Regardless of when you can pick up your exam, any dispute of points will need to be handled prior to that to ensure integrity. Detailed solutions and rubric will be available.

# More Announcements

Still need to grade A3

A4 out in 1 week, you will have about 2 weeks

A4 is about the Unix shell (the program that provides the command line interface you have been using on the cycle machines). You will write your own Unix shell!

After A4, A5 will be the last assignment and it will be about memory allocation (as in malloc)



# So far in 252...

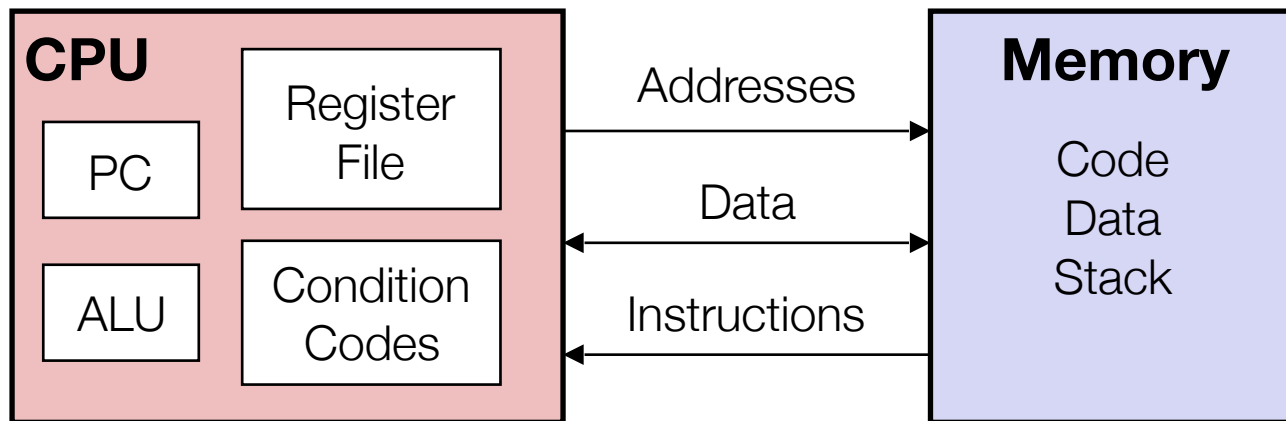

- We have been discussing the CPU microarchitecture
  - Single Cycle, sequential implementation
  - Pipeline implementation
  - Resolving data dependency and control dependency
- What about memory?

# Ideal Memory

- Zero access time (latency)
- Infinite capacity
- Zero cost
- Infinite bandwidth (to support multiple accesses in parallel)

# The Problem

- Ideal memory's requirements oppose each other

# The Problem

- Ideal memory's requirements oppose each other
- Bigger is slower

# The Problem

- Ideal memory's requirements oppose each other
- Bigger is slower
  - Bigger → Takes longer to determine the location

# The Problem

- Ideal memory's requirements oppose each other
- Bigger is slower
  - Bigger → Takes longer to determine the location
- Faster is more expensive

# The Problem

- Ideal memory's requirements oppose each other
- Bigger is slower
  - Bigger → Takes longer to determine the location
- Faster is more expensive
  - Memory technology: Flip-flop vs. SRAM vs. DRAM vs. Disk vs. Tape

# The Problem

- Ideal memory's requirements oppose each other
- Bigger is slower
  - Bigger → Takes longer to determine the location
- Faster is more expensive
  - Memory technology: Flip-flop vs. SRAM vs. DRAM vs. Disk vs. Tape
- Higher bandwidth is more expensive



# The Problem

- Ideal memory's requirements oppose each other
- Bigger is slower
  - Bigger → Takes longer to determine the location
- Faster is more expensive
  - Memory technology: Flip-flop vs. SRAM vs. DRAM vs. Disk vs. Tape
- Higher bandwidth is more expensive
  - Need more ports, higher frequency, or faster technology

# Memory Technology: D Flip-Flop (DFF)

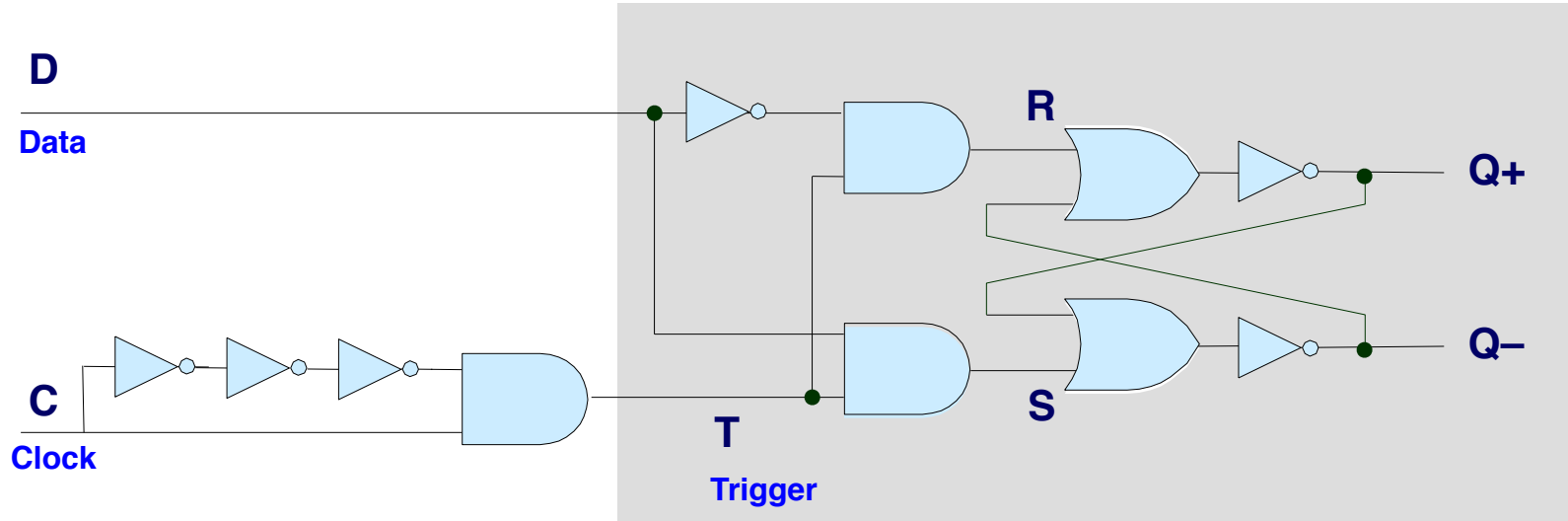

- Very fast
- Very expensive to build
  - 6 NOT gates (2 transistors / gate)
  - 3 AND gates (3 transistors / gate)
  - 2 OR gates (3 transistors / gate)
  - 27 transistors in total for just one bit!!

# Memory Technology: SRAM

- Static random access memory
- Random access means you can supply an arbitrary address to the memory and get a value back
- Two cross coupled inverters store a single bit
  - Feedback path enables the stored value to persist in the “cell”
  - 4 transistors for storage
  - 2 transistors for access
  - 6 transistors in total per bit

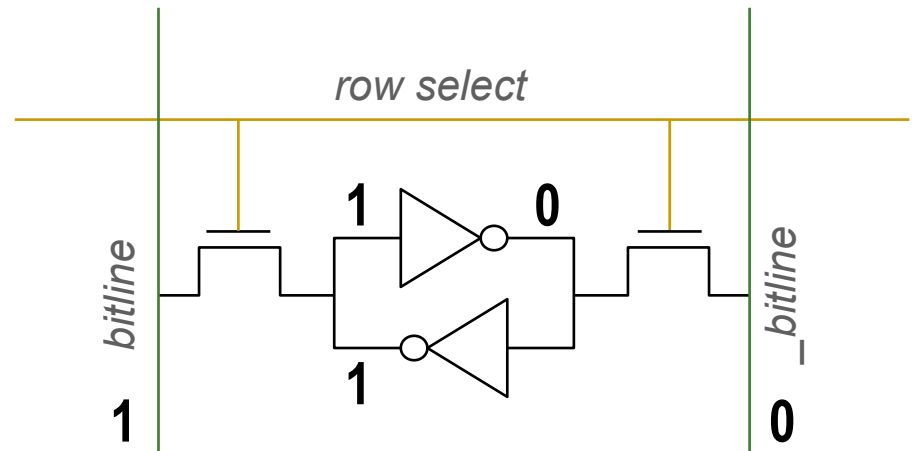

# SRAM Array

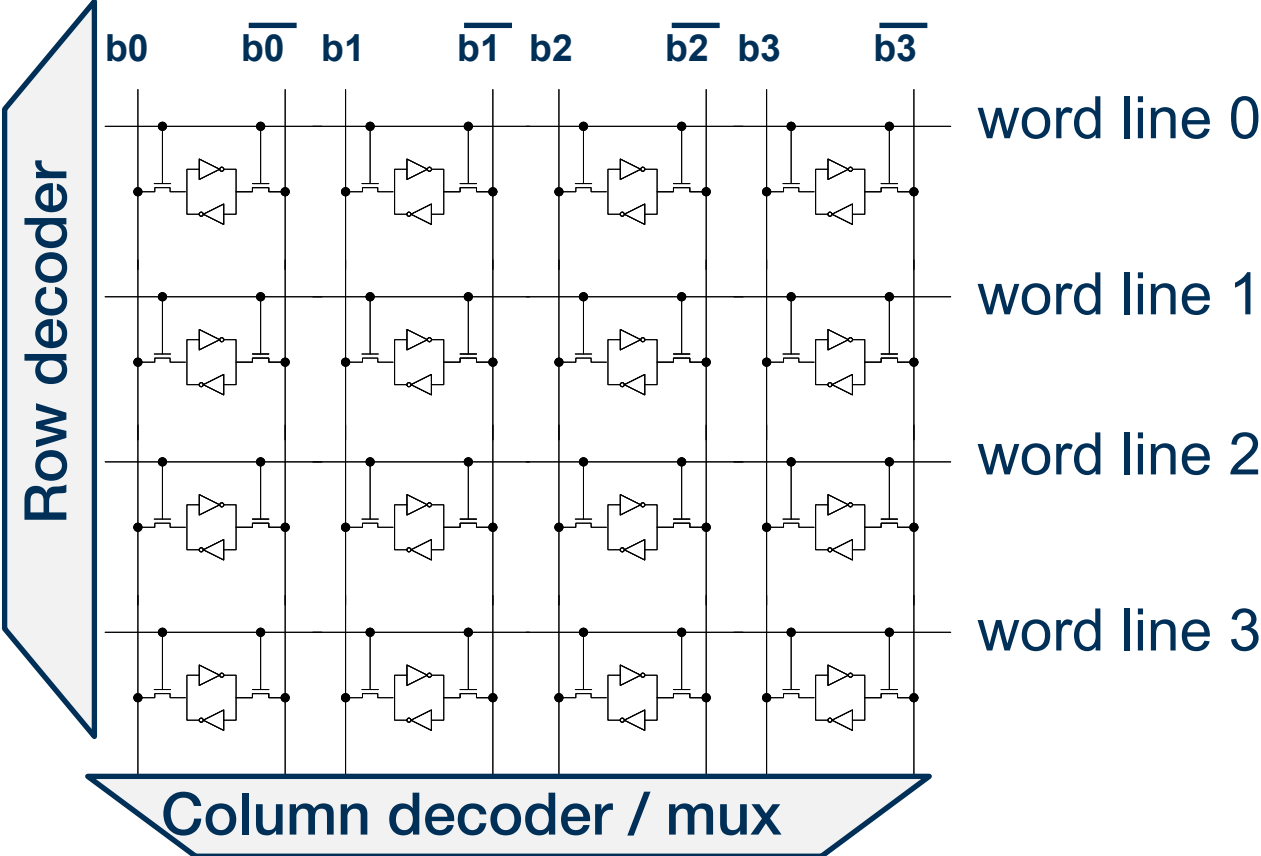

# Memory Technology: DRAM

- Dynamic random access memory

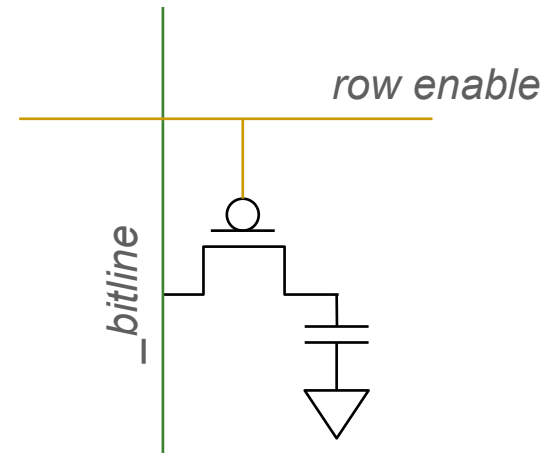

# Memory Technology: DRAM

- Dynamic random access memory
- Capacitor charge state indicates stored value
  - Whether the capacitor is charged or discharged indicates storage of 1 or 0
  - 1 capacitor
  - 1 access transistor

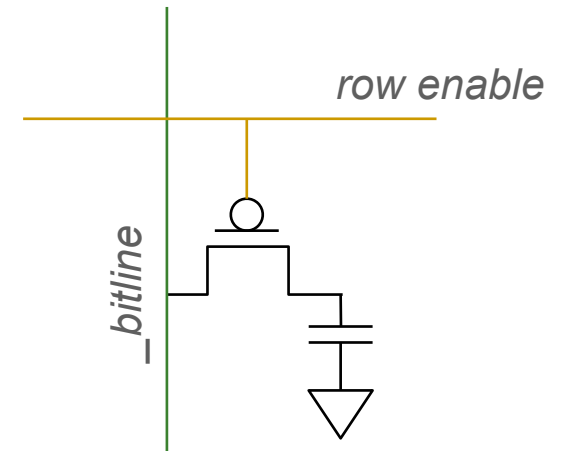

# DRAM Cell

- Capacitors will leak!
  - DRAM cell loses charge over time
  - DRAM cell needs to be **refreshed** periodically.
  - Refresh takes time and power. When refreshing can't read the data. A major issue, lots of research going on to reduce the refresh overhead.

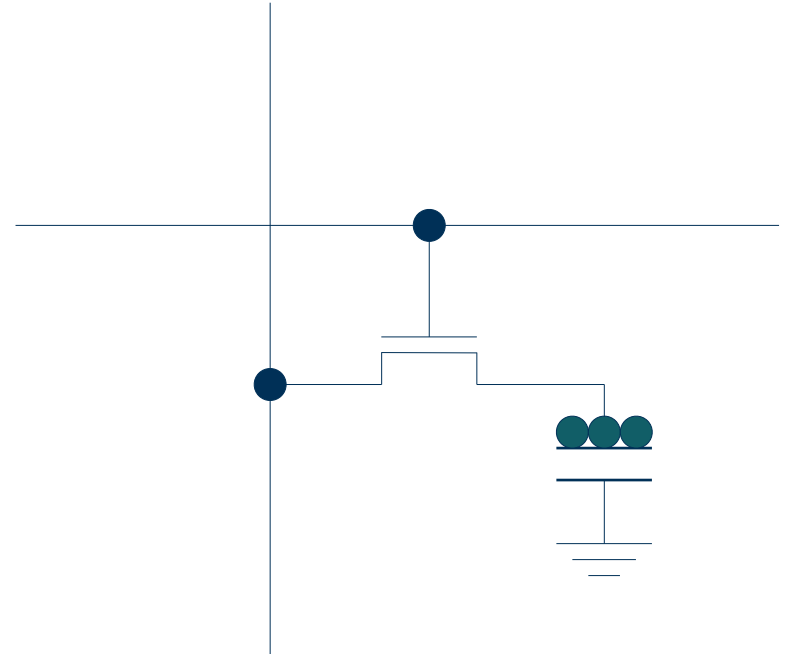

# DRAM Cell

- Capacitors will leak!
  - DRAM cell loses charge over time
  - DRAM cell needs to be **refreshed** periodically.
  - Refresh takes time and power. When refreshing can't read the data. A major issue, lots of research going on to reduce the refresh overhead.

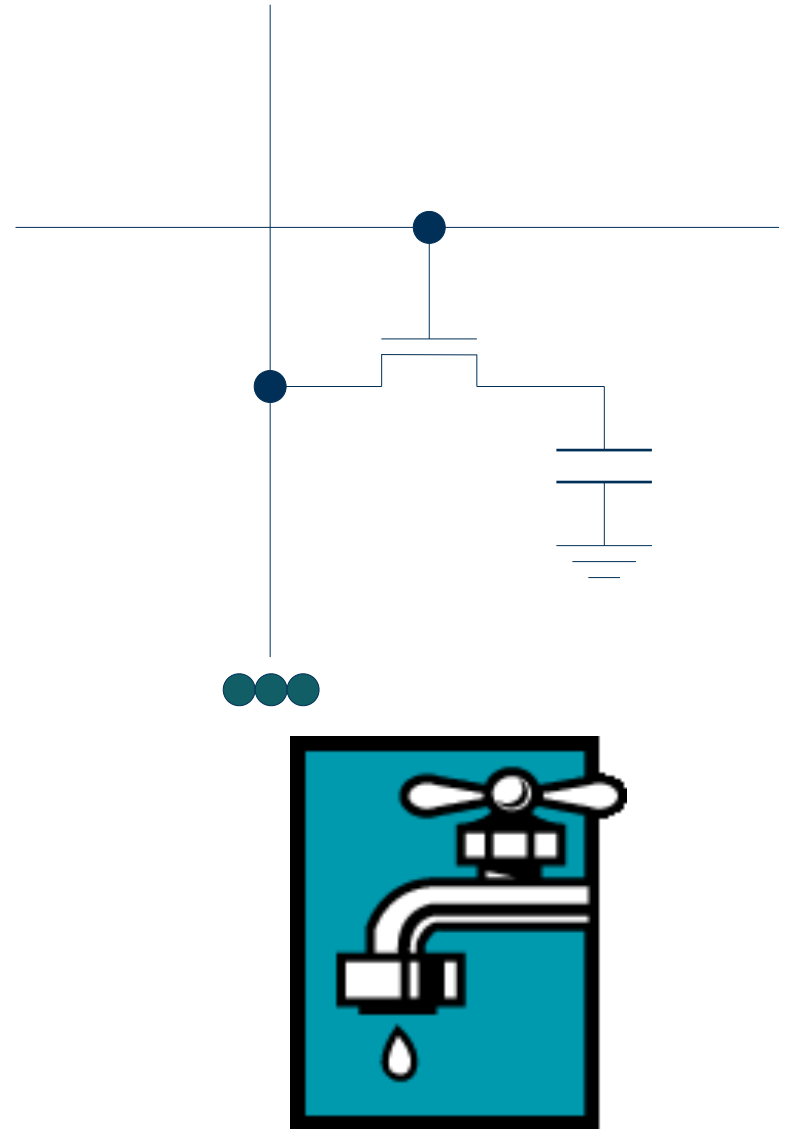



# DRAM Cell

- Capacitors will leak!
  - DRAM cell loses charge over time
  - DRAM cell needs to be **refreshed** periodically.
  - Refresh takes time and power. When refreshing can't read the data. A major issue, lots of research going on to reduce the refresh overhead.

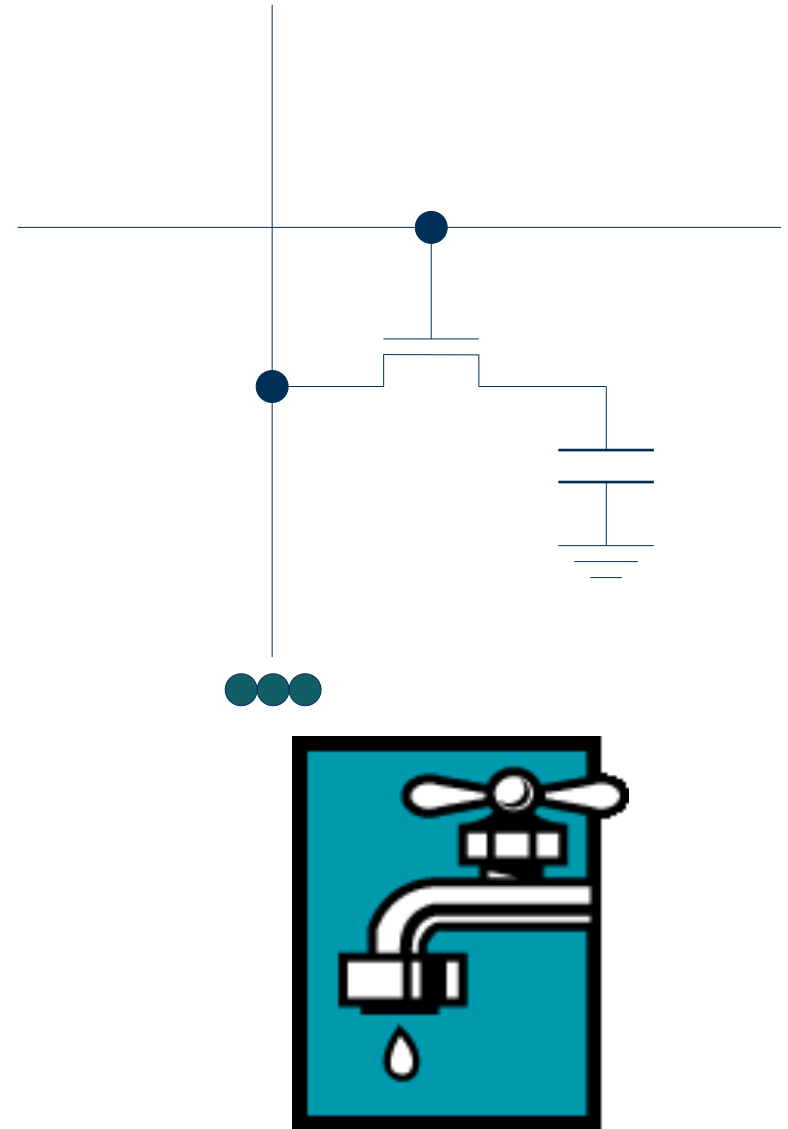

# Latch vs. DRAM vs. SRAM

- DFF
  - Fastest
  - Low density (27 transistors per bit)
  - High cost
- SRAM
  - Faster access (no capacitor)
  - Lower density (6 transistors per bit; there are designs w/ fewer Ts)
  - Higher cost
  - No need for refresh
  - Manufacturing compatible with logic process (no capacitor)
- DRAM
  - Slower access (capacitor)
  - Higher density (1 transistor + 1 capacitor per bit)
  - Lower cost
  - Requires refresh (power, performance, circuitry)
  - Manufacturing requires putting capacitor and logic together

# Nonvolatile Memories

# Nonvolatile Memories

- DFF, DRAM and SRAM are volatile memories
  - Lose information if powered off.

# Nonvolatile Memories

- DFF, DRAM and SRAM are volatile memories
  - Lose information if powered off.
- Nonvolatile memories retain value even if powered off
  - Flash (~ 5 years)
  - Hard Disk (~ 5 years)
  - Tape (~ 15-30 years)
  - DNA (centuries)

# Nonvolatile Memories

- DFF, DRAM and SRAM
  - Lose information if power is lost
- Nonvolatile memories retain information
  - Flash (~ 5 years)
  - Hard Disk (~ 5 years)
  - Tape (~ 15-30 years)
  - DNA (centuries)

---

## Rewriting Life

---

# Microsoft Has a Plan to Add DNA Data Storage to Its Cloud

Tech companies think biology may solve a looming data storage problem.

by Antonio Regalado    May 22, 2017

**Based on early research involving the storage of movies and documents in DNA**, Microsoft is developing an apparatus that uses biology to replace tape drives, researchers at the company say.

Computer architects at Microsoft Research say the company has formalized a goal of having an operational storage system based on DNA

# Nonvolatile Memories

- DFF, DRAM and SRAM are volatile memories
  - Lose information if powered off.
- Nonvolatile memories retain value even if powered off
  - Flash (~ 5 years)
  - Hard Disk (~ 5 years)
  - Tape (~ 15-30 years)
  - DNA (centuries)
- Uses for Nonvolatile Memories
  - Firmware (BIOS, controllers for disks, network cards, graphics accelerators, security subsystems,...)
  - Files in Smartphones, mp3 players, tablets, laptops
  - Backup

# Summary of Trade-Offs

- **Bigger is slower**
  - Flip-flops/Small SRAM, sub-nanosec
  - SRAM, KByte~MByte, ~nanosec
  - DRAM, Gigabyte, ~50 nanosec
  - Hard Disk, Terabyte, ~10 millisec
- **Faster is more expensive (dollars and chip area)**
  - SRAM, < 10\$ per Megabyte
  - DRAM, < 1\$ per Megabyte
  - Hard Disk < 1\$ per Gigabyte
- Other technologies have their place as well
  - PC-RAM, MRAM, RRAM



# We want both fast and large Memory

- But we cannot achieve both with a single level of memory
- Idea: Memory Hierarchy
  - Have multiple levels of storage (progressively bigger and slower as the levels are farther from the processor)
  - Key: manage the data such that most of the data the processor needs in the near future is kept in the fast(er) level(s)

# Memory Hierarchy

move what you use here

backup everything here

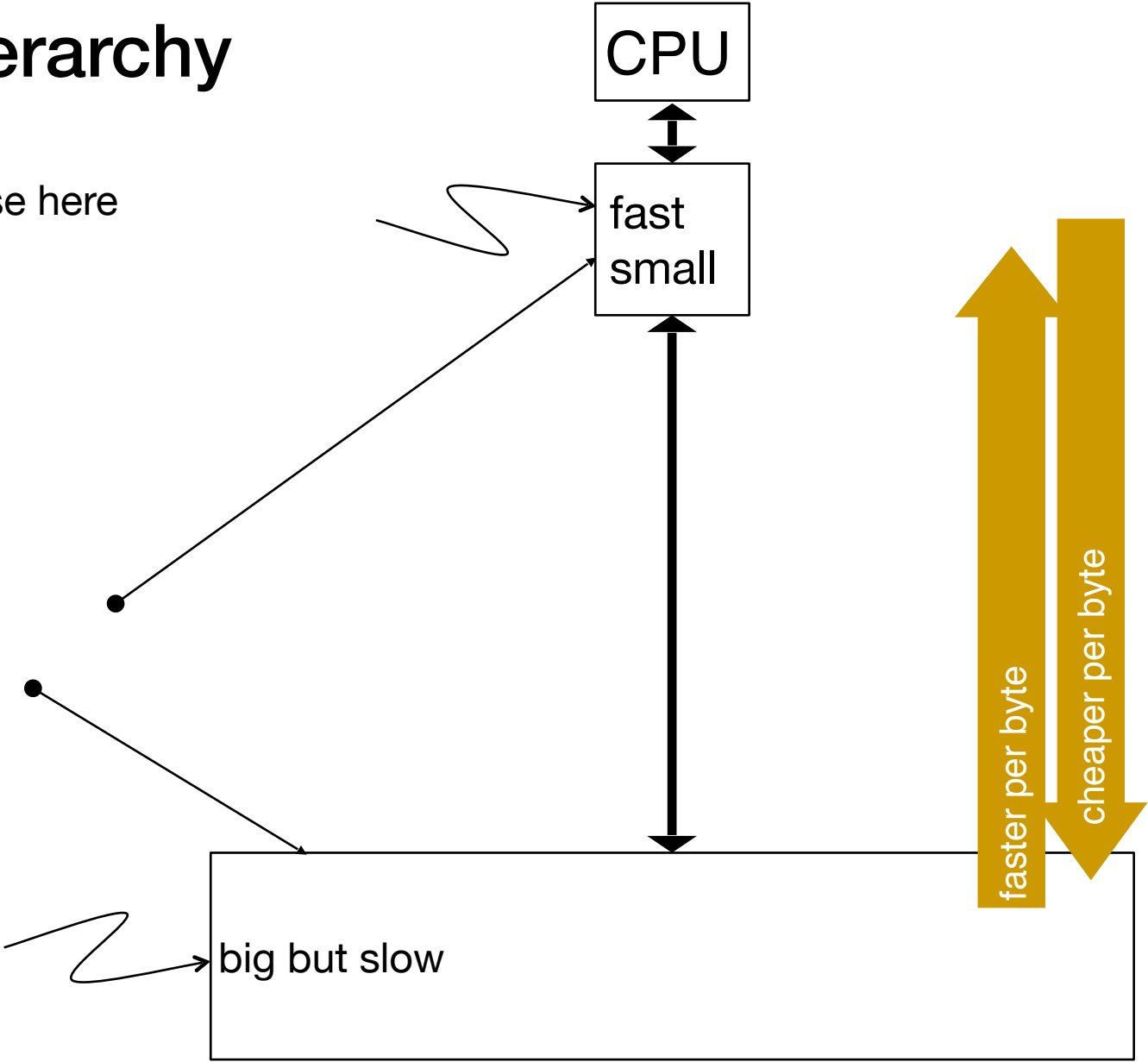

# Memory Hierarchy

move what you use here

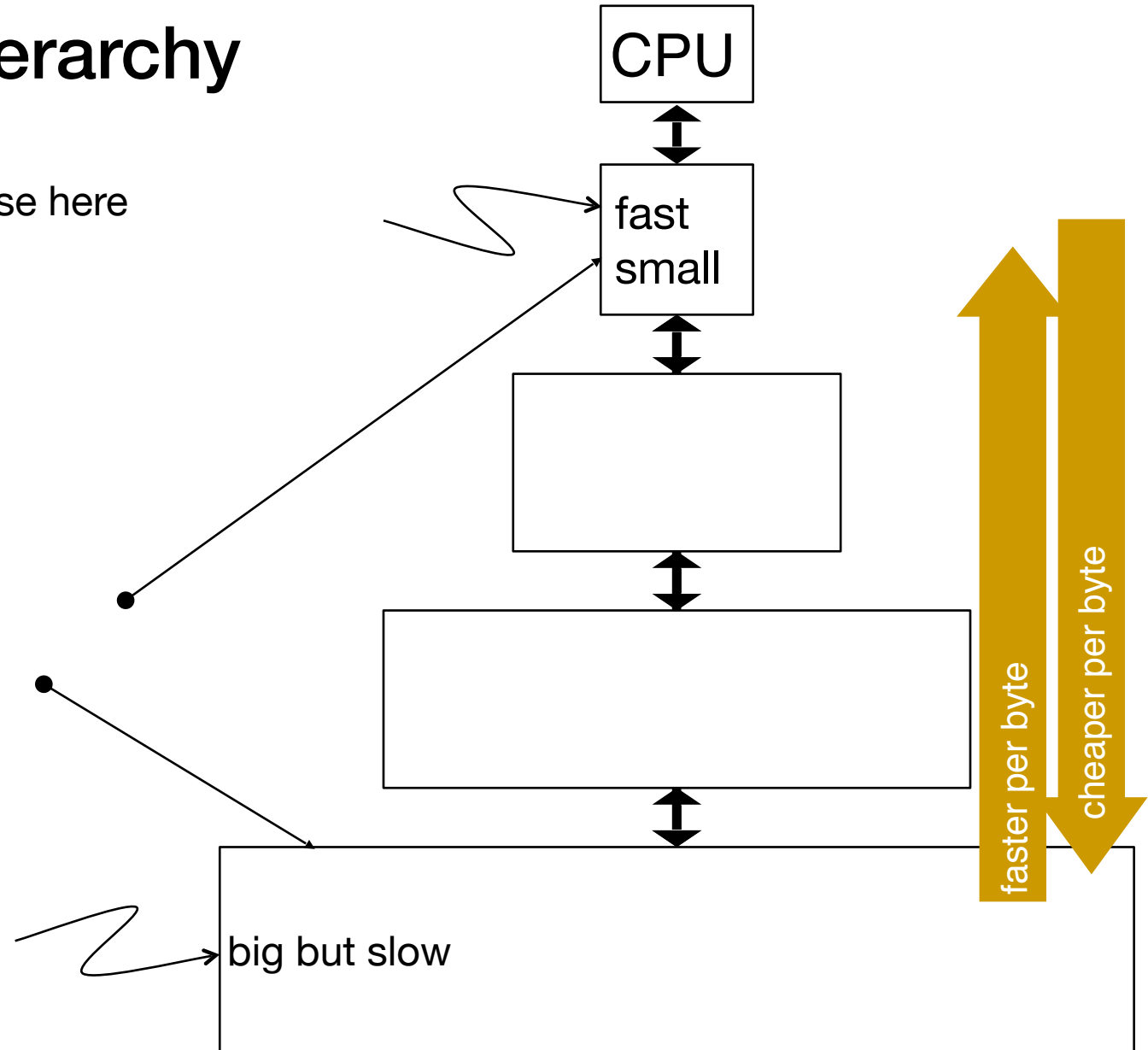

backup  
everything  
here

# Memory Hierarchy

- Fundamental tradeoff
  - Fast memory: small
  - Large memory: slow
- Balance latency, cost, size, bandwidth

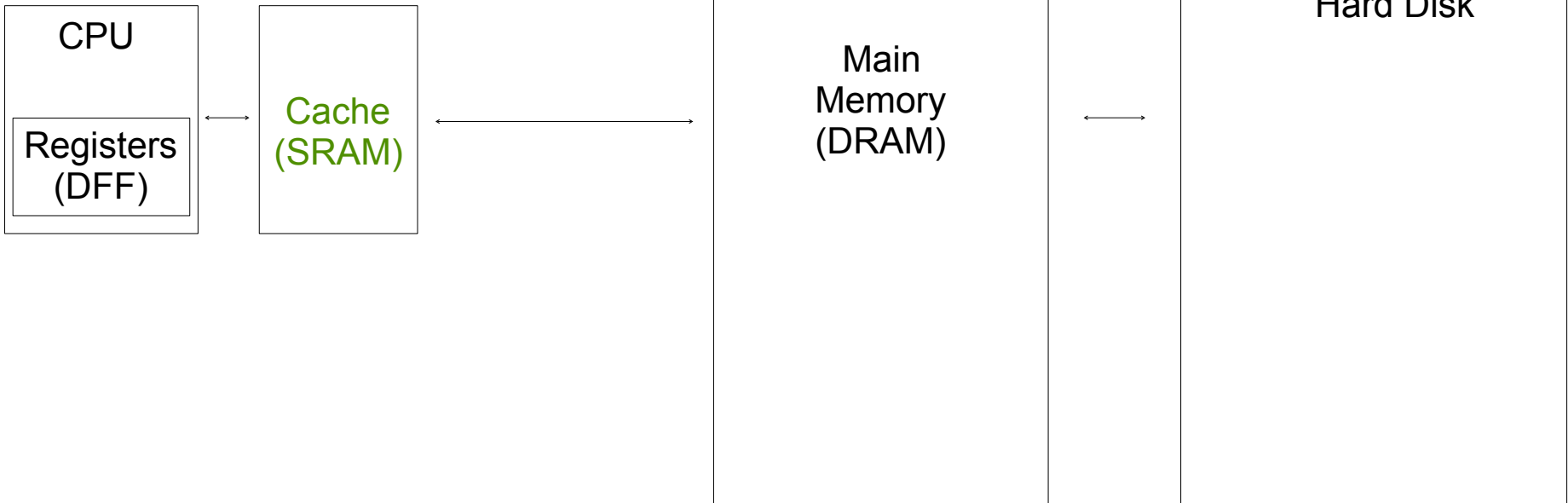

# A Modern Memory Hierarchy

Register File (DFF)  
32 words, sub-nsec

---

L1 cache (SRAM)  
~32 KB, ~nsec

L2 cache (SRAM)  
512 KB ~ 1MB, many nsec

L3 cache (SRAM)  
.....

Main memory (DRAM),  
GB, ~100 nsec

---

Hard Disk  
100 GB, ~10 msec

# Memory in a Modern System

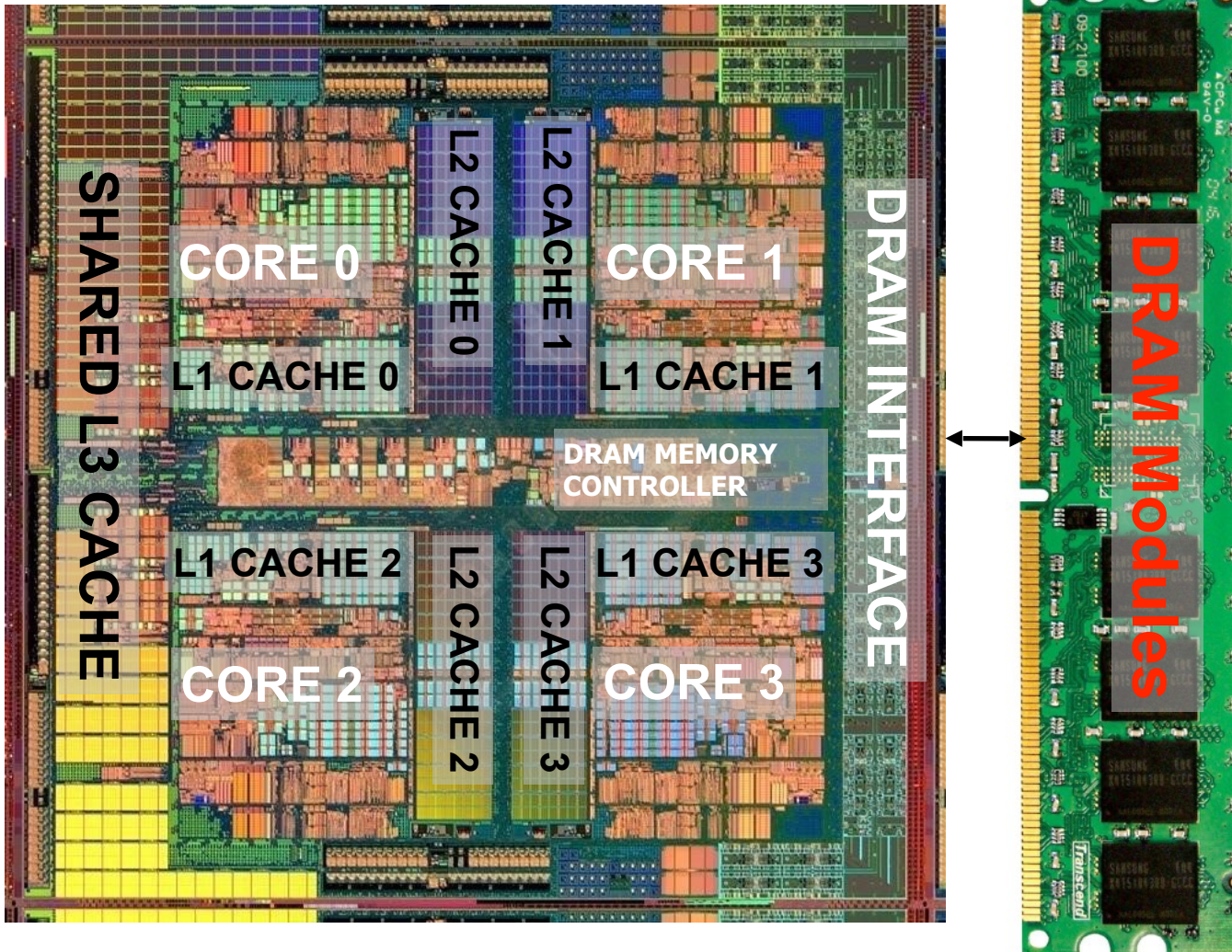

# How Things Have Progressed

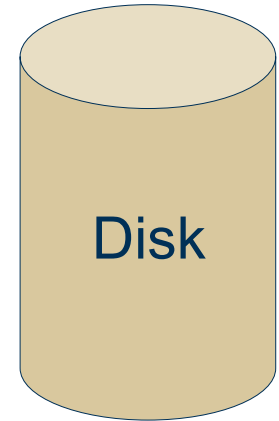
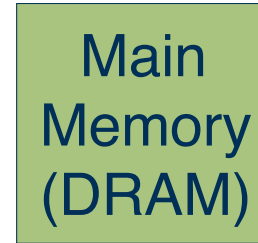
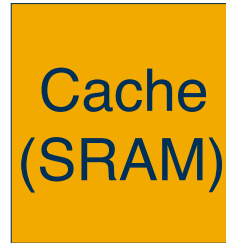
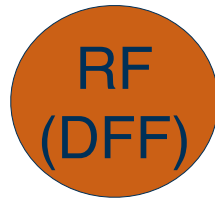

	RF (DFF)	Cache (SRAM)	Main Memory (DRAM)	Disk
<b>1995 low-mid range</b> <small>Hennessy &amp; Patterson, Computer Arch., 1996</small>	200B 5ns	64KB 10ns	32MB 100ns	2GB 5ms
<b>2009 low-mid range</b> <small><a href="http://www.dell.com">www.dell.com</a>, \$449 including 17" LCD flat panel</small>	~200B 0.33ns	8MB 0.33ns	4GB <100ns	750GB 4ms
<b>2015 mid range</b>	~200B 0.33ns	8MB 0.33ns	16GB <100ns	<b>256GB</b> <b>10us</b>

# How to Make Effective Use of the Hierarchy

- Fundamental question: how do we know what data to put in the fast and small memory?
- Answer: ensure most of the data the processor needs **in the near future** is kept in the fast(er) level(s)
- How do we know what data will be needed in the future?
  - Do we know before the program runs?
    - If so, programmers or compiler can place the right data at the right place
  - Do we know only after the program runs?
    - If so, only the hardware can effectively place the data



# How to Make Effective Use of the Hierarchy

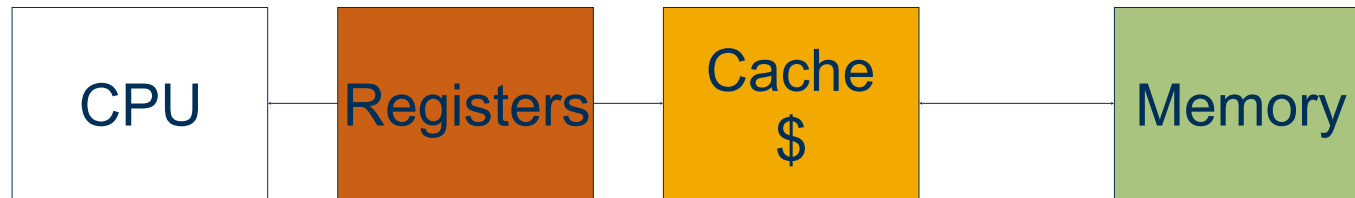

- Modern computers provide both ways
- Register file: programmers explicitly move data from the main memory (slow but big DRAM) to registers (small, very fast)
  - `movq (%rdi), %rdx`
- **Cache**, on the other hand, is automatically managed by hardware
  - Sits between registers and main memory, “invisible” to programmers
  - The hardware automatically figures out what data will be used in the near future, and place in the cache.
  - How does the hardware know that??

# Locality: An Empirical Observation

- **Principle of Locality:** Programs tend to use the same data over and over again, and tend to access data next to each other.

# Locality: An Empirical Observation

- **Principle of Locality:** Programs tend to use the same data over and over again, and tend to access data next to each other.
- **Temporal locality:**
  - Recently referenced items are likely to be referenced again in the near future

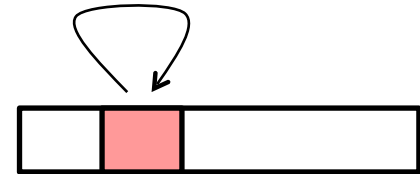

# Locality: An Empirical Observation

- **Principle of Locality:** Programs tend to use the same data over and over again, and tend to access data next to each other.
- **Temporal locality:**
  - Recently referenced items are likely to be referenced again in the near future
- **Spatial locality:**
  - Items with nearby addresses tend to be referenced close together in time

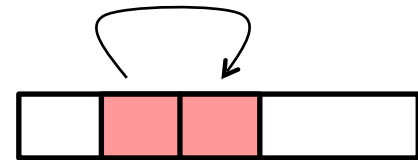
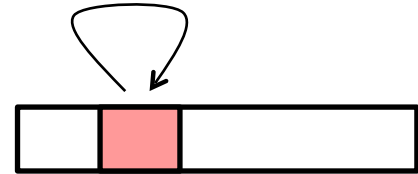

# Locality Example

```
sum = 0;  
for (i = 0; i < n; i++)  
    sum += a[i];  
return sum;
```

- Data references
  - **Spatial** Locality: Reference array elements in succession (stride-1 reference pattern)
  - **Temporal** Locality: Reference variable sum each iteration.
- Instruction references
  - **Spatial** Locality: Reference instructions in sequence.
  - **Temporal** Locality: Cycle through loop repeatedly.

# Use Locality to Manage Memory Hierarchy

```
sum = 0;  
for (i = 0; i < n; i++)  
    sum += a[i];  
return sum;
```

- Exploiting temporal locality:
  - If a piece of data is recently accessed, very likely it will be needed again, so moved it to cache.
- Exploiting spatial locality:
  - When moving a piece of data from the memory to the cache, move its adjacent data to the cache as well.

# The Bookshelf Analogy

- Book in your hand
  - Desk
  - Bookshelf
  - Boxes at home
  - Library
- 
- Recently-used books tend to stay on desk, because you will likely use it again.
    - Comp Org. books, books for classes you are currently taking
  - Organize books in the shelf such that adjacent books are mostly accessed around the same time

# Cache Illustrations

CPU



Memory  
(big but slow)

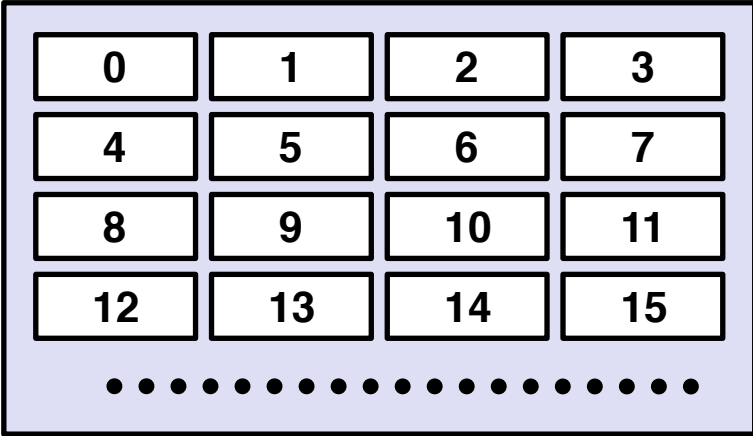



# Cache Illustrations

CPU



Cache  
(small but fast)

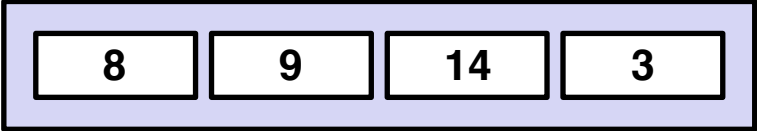

Memory  
(big but slow)

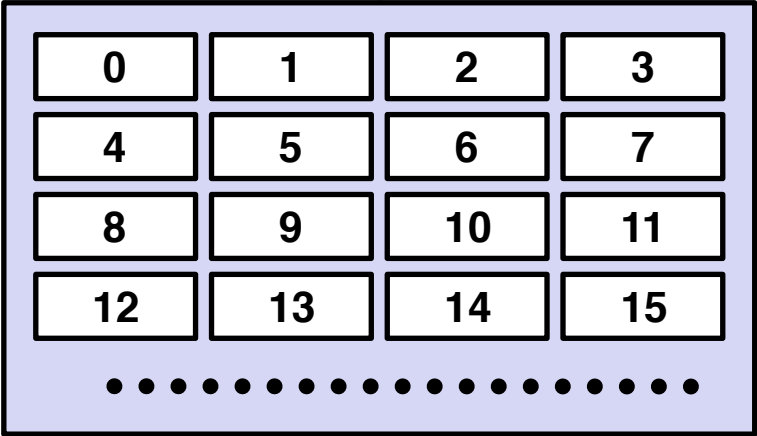

# Cache Illustrations

CPU



Request Data  
at Address 14

*Data in address b is needed*

Cache  
(small but fast)

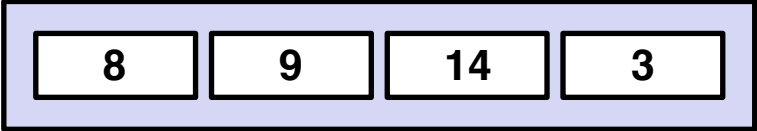

Memory  
(big but slow)

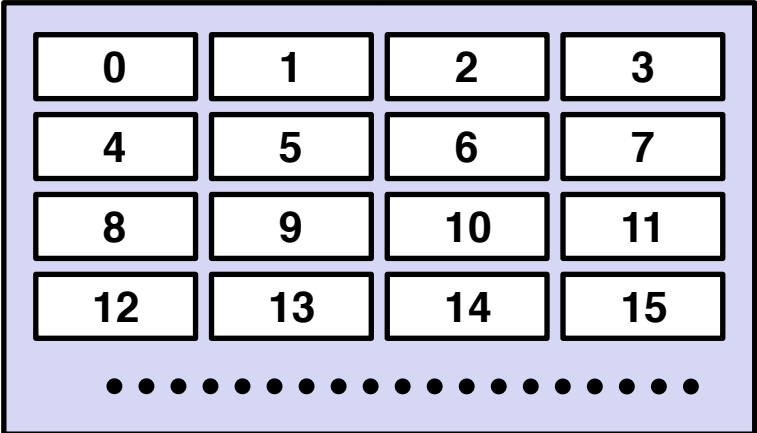

# Cache Illustrations

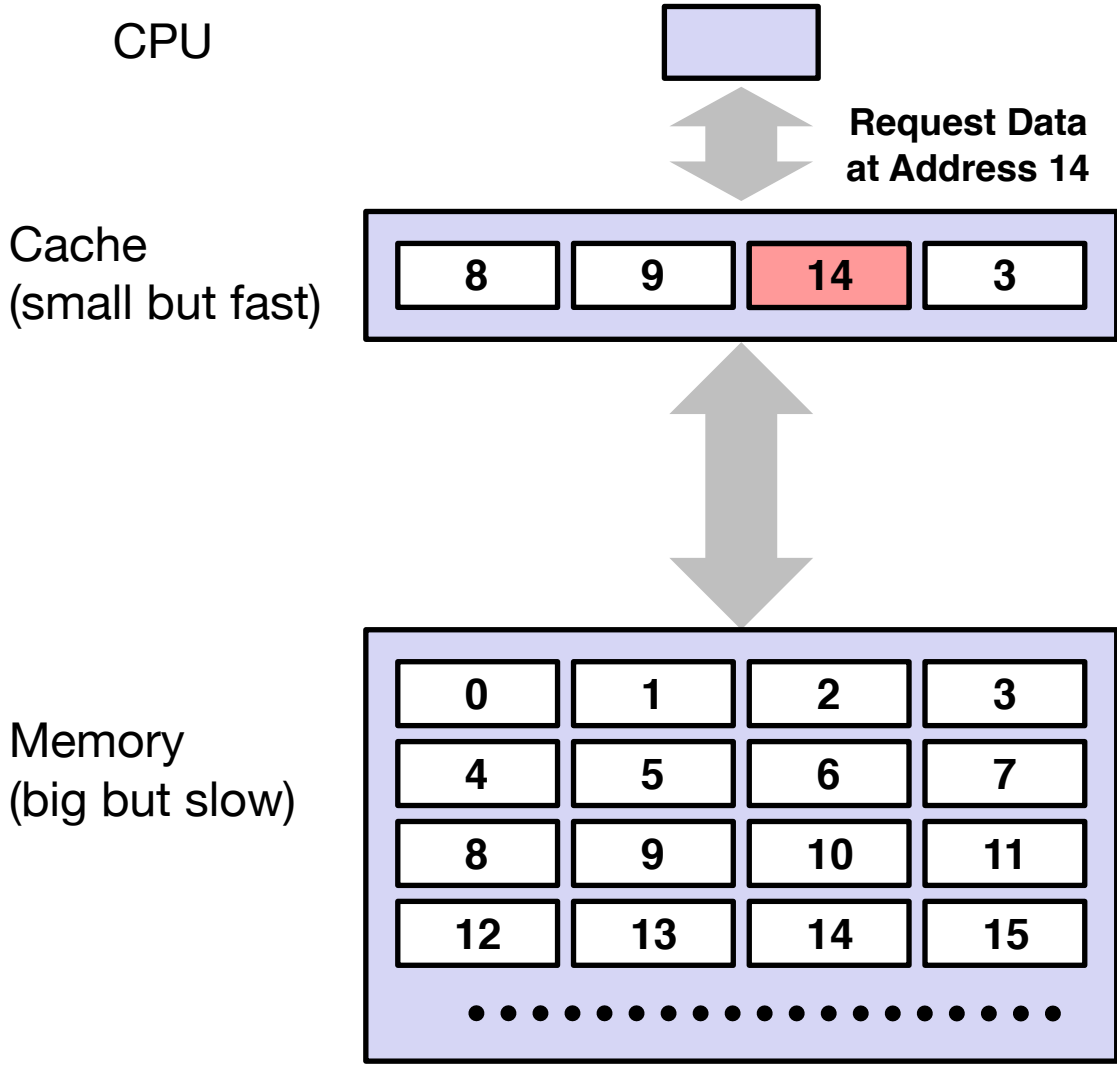

*Data in address b is needed*

*Address b is in cache: Hit!*

# Cache Illustrations

CPU



Cache  
(small but fast)

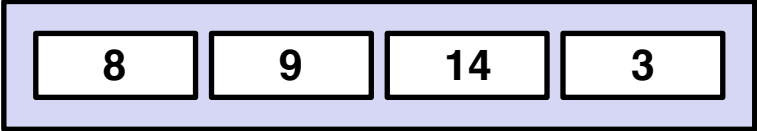

Memory  
(big but slow)

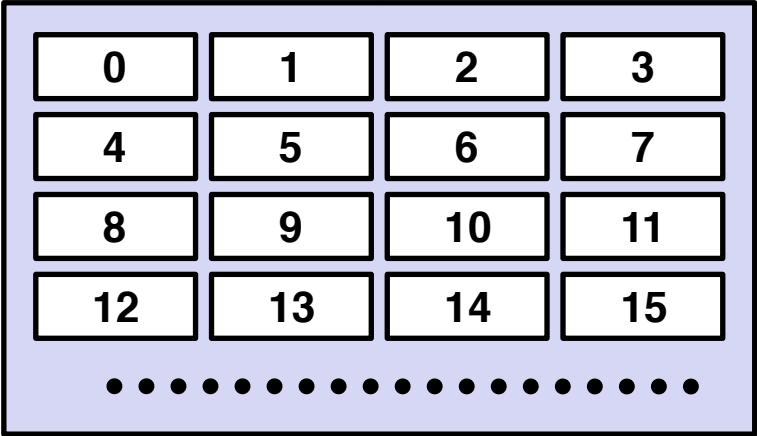

# Cache Illustrations

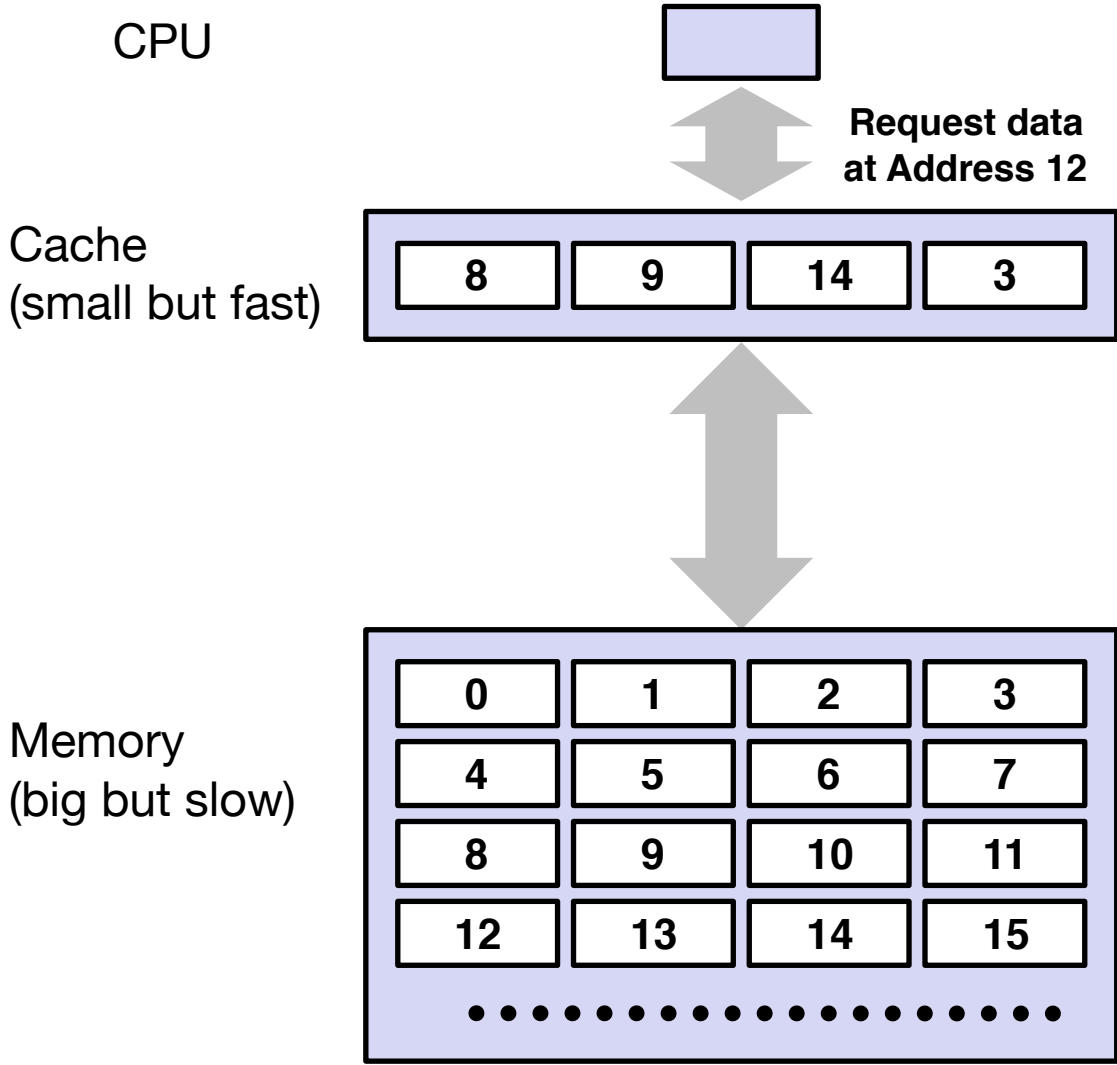

# Cache Illustrations

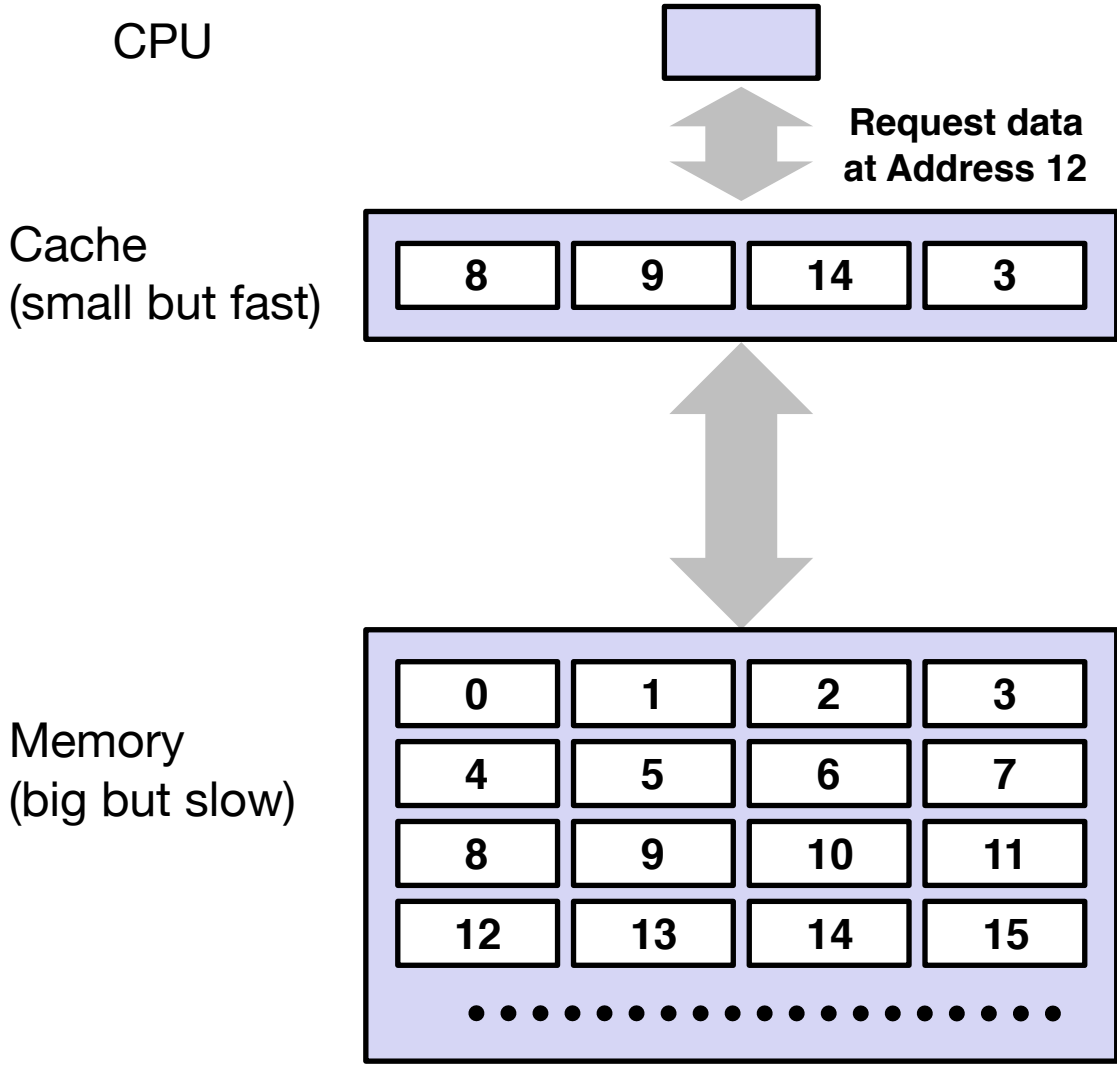

*Data in address b is needed*

*Address b is not in cache: **Miss!***

# Cache Illustrations

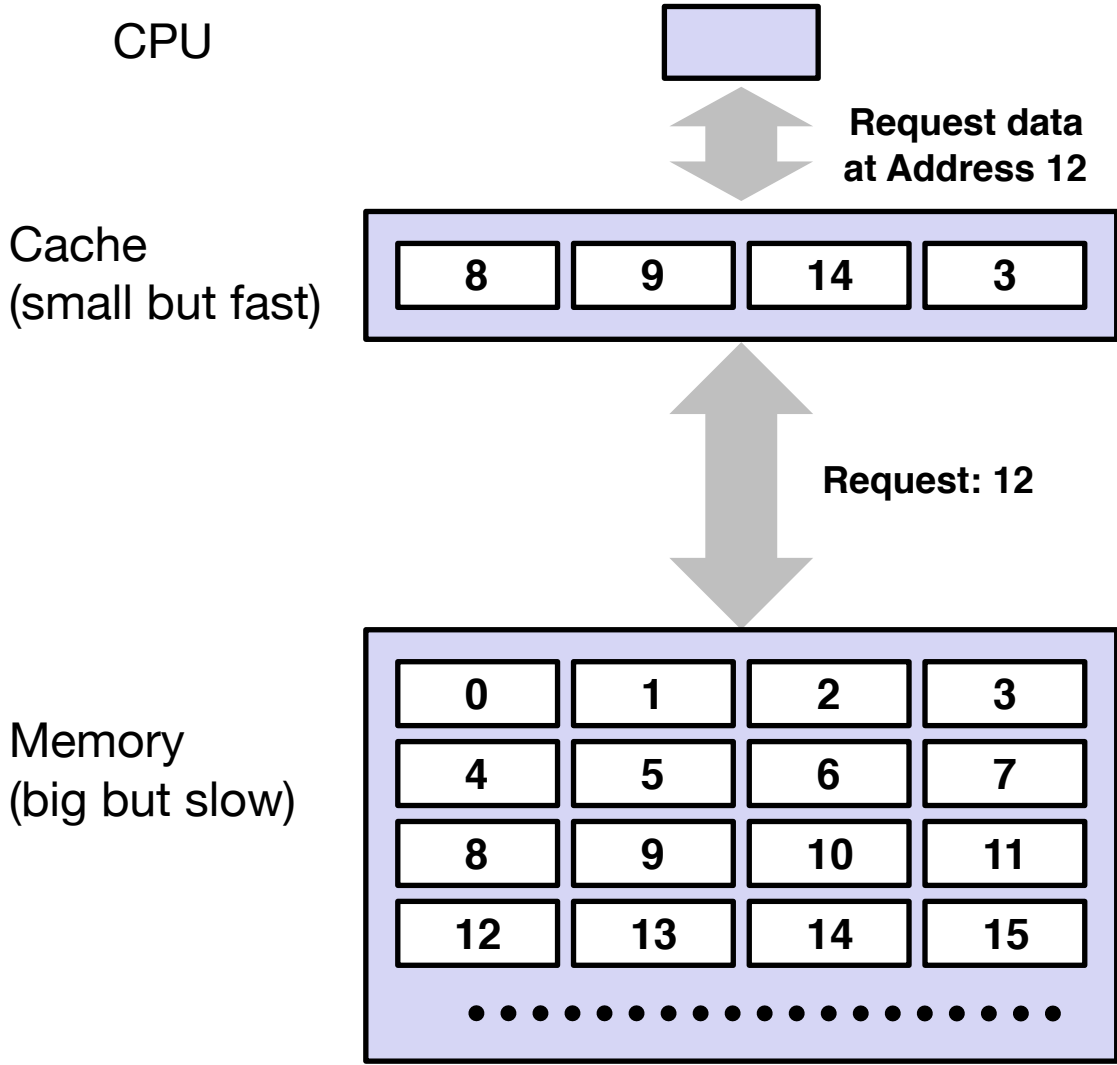

*Data in address b is needed*

*Address b is not in cache: **Miss!***

*Address b is fetched from memory*

# Cache Illustrations

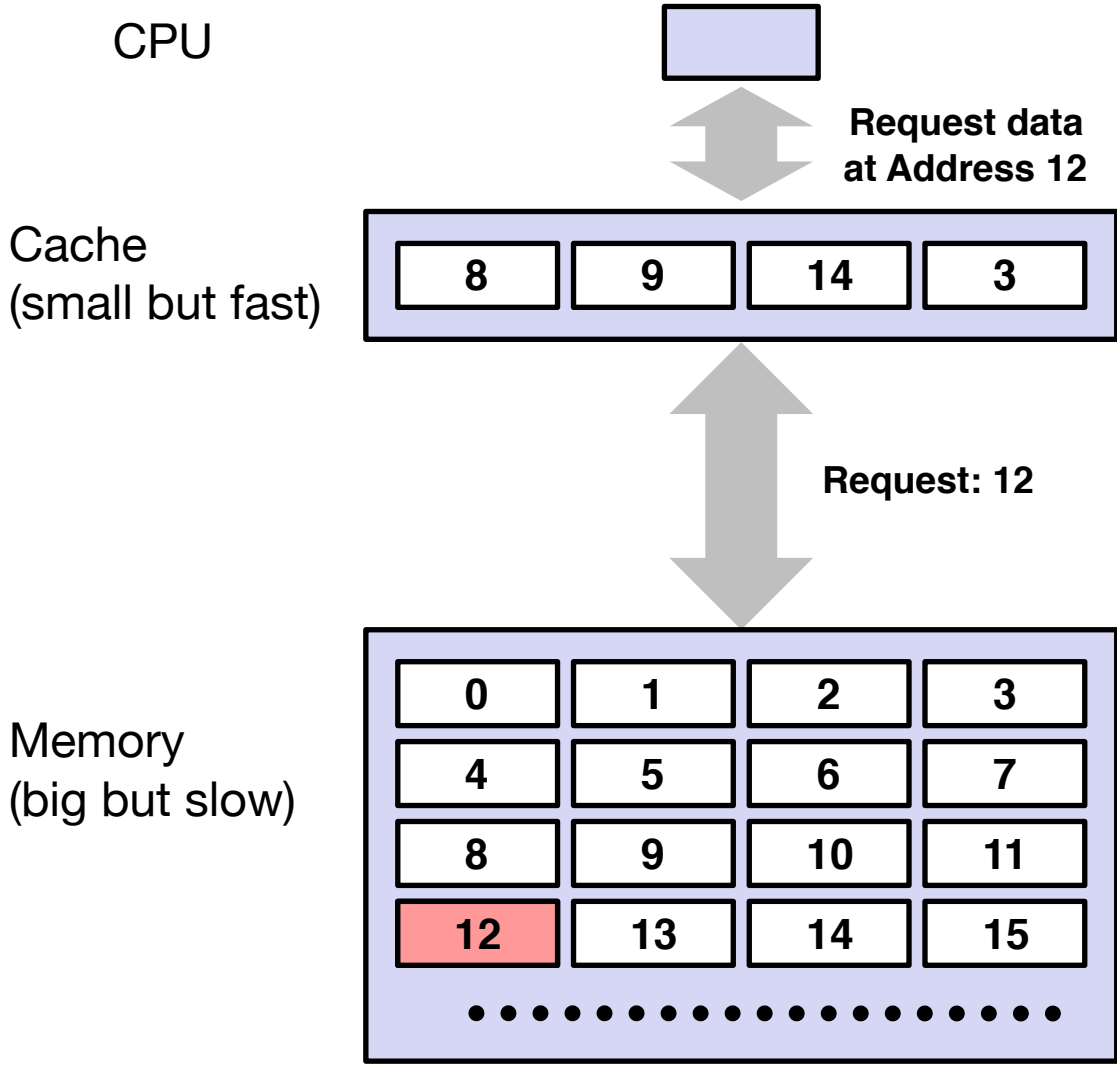

*Data in address b is needed*

*Address b is not in cache: **Miss!***

*Address b is fetched from memory*



# Cache Illustrations

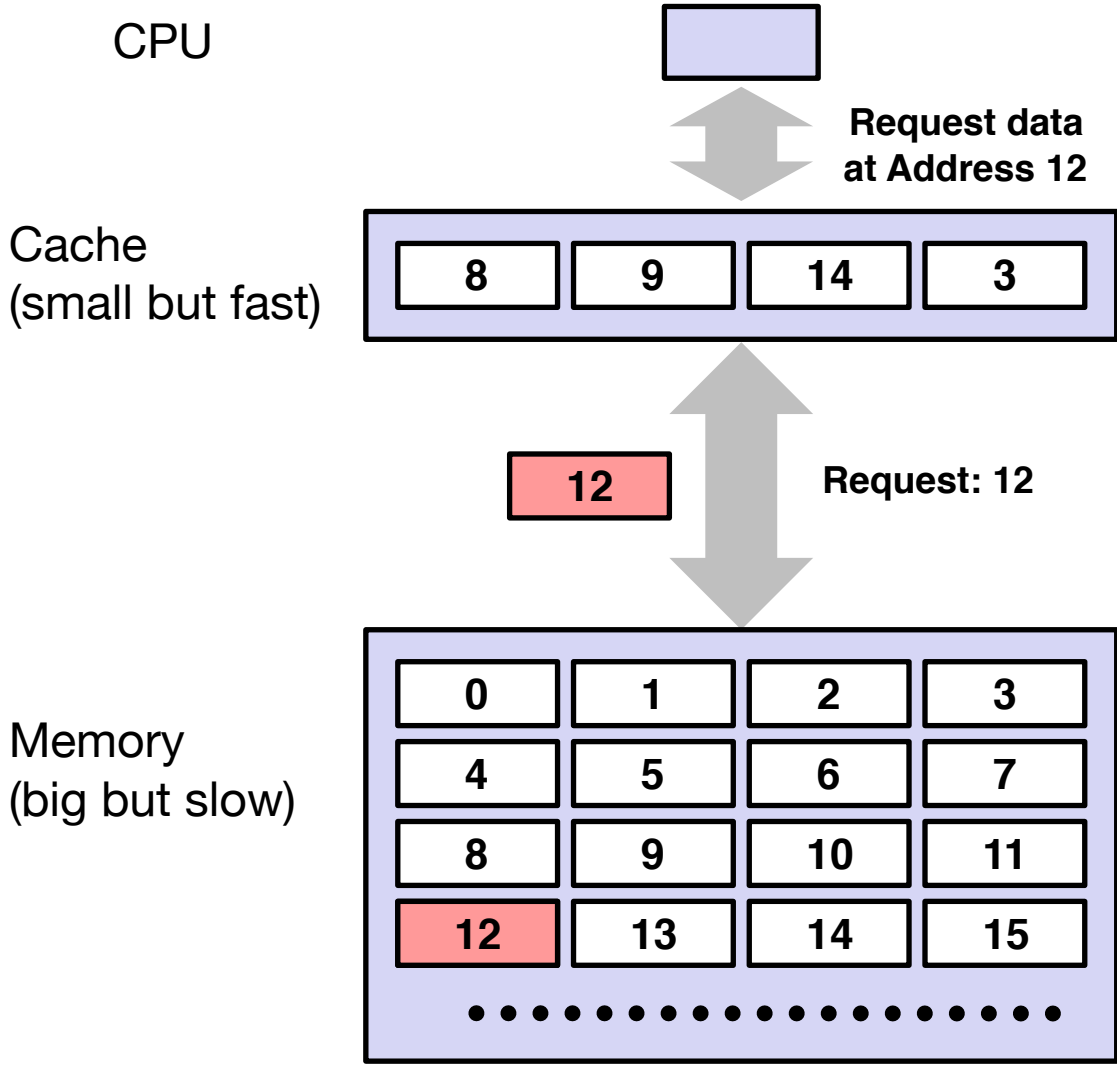

*Data in address b is needed*

*Address b is not in cache: **Miss!***

*Address b is fetched from memory*

# Cache Illustrations

CPU



Request data  
at Address 12

Cache  
(small but fast)

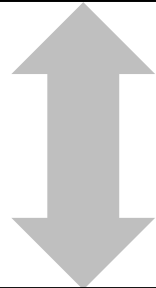
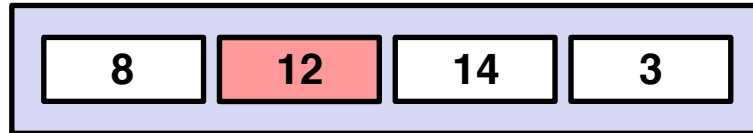

Request: 12

Memory  
(big but slow)

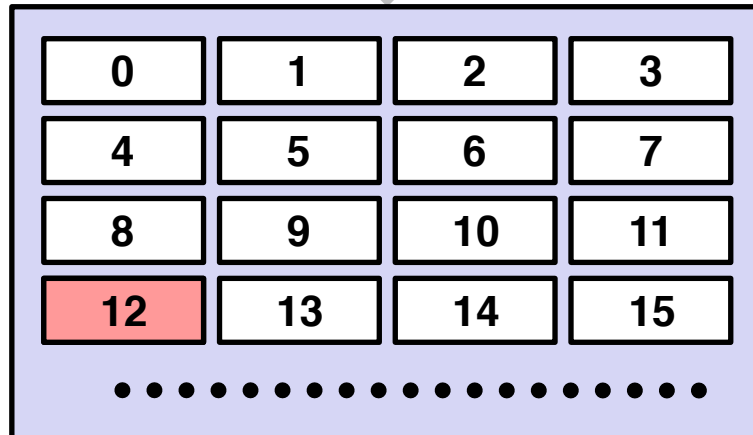

*Data in address b is needed*

*Address b is not in  
cache: **Miss!***

*Address b is fetched from  
memory*

*Address b is stored in cache*

# Cache Hit Rate

- Cache hit is when you find the data in the cache
- Hit rate indicates the effectiveness of the cache

$$\text{Hit Rate} = \frac{\# \text{ Hits}}{\# \text{ Accesses}}$$

# Two Fundamental Issues in Cache Management

- Finding the data in the cache
  - Given an address, how do we decide whether it's in the cache or not?
- Kicking data out of the cache
  - Cache is smaller than memory, so when there's no place left in the cache, we need to kick something out before we can put new data into it, but who to kick out?

# A Simple Cache

Cache

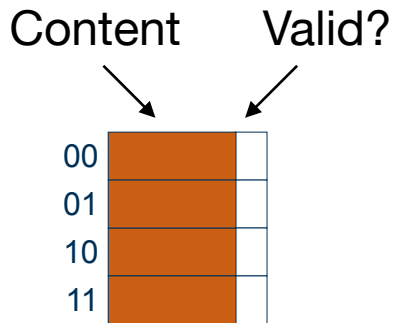

Memory

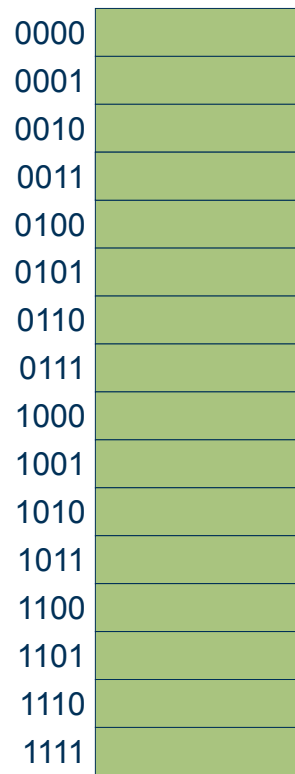

- 16 memory locations
- 4 cache locations

# A Simple Cache

Cache

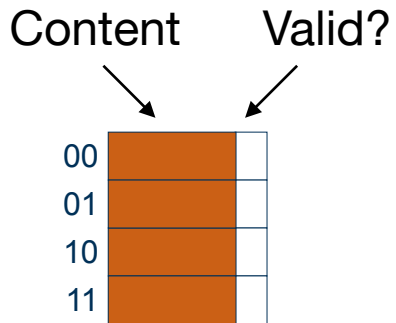

Memory

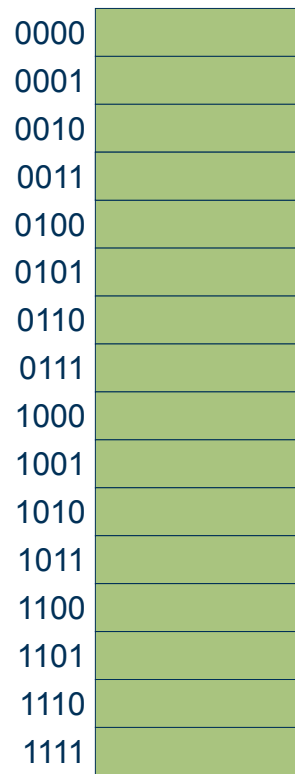

- 16 memory locations
- 4 cache locations
  - Also called **cache-line**

# A Simple Cache

Cache

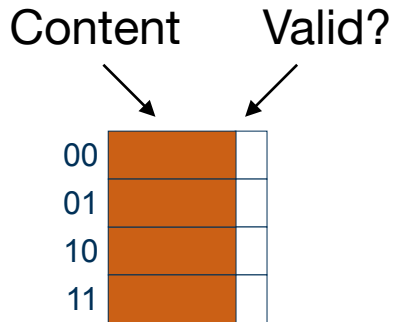

Memory

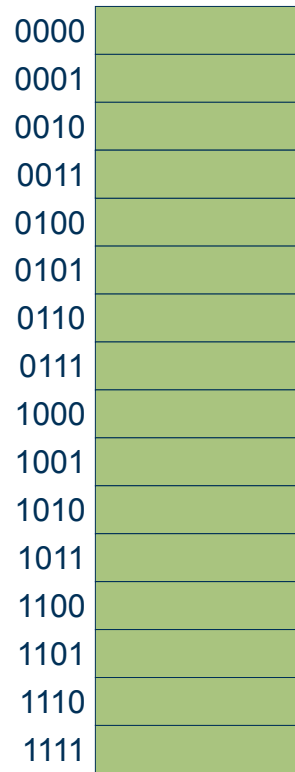

- 16 memory locations
- 4 cache locations
  - Also called **cache-line**
  - Every location has a valid bit, indicating whether that location contains valid data; 0 initially.

# A Simple Cache

Cache

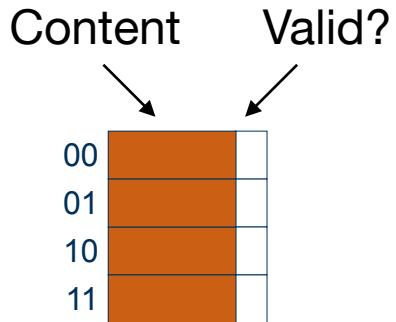

Memory

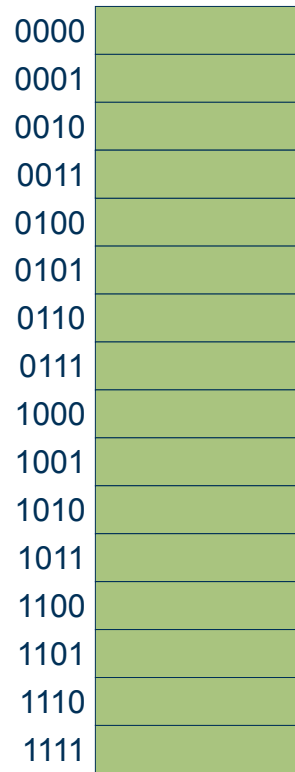

- 16 memory locations
- 4 cache locations
  - Also called **cache-line**
  - Every location has a valid bit, indicating whether that location contains valid data; 0 initially.
- For now, assume cache location size == memory location size == 1 B



# A Simple Cache

Cache

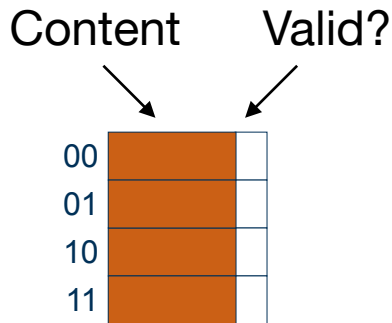

Memory

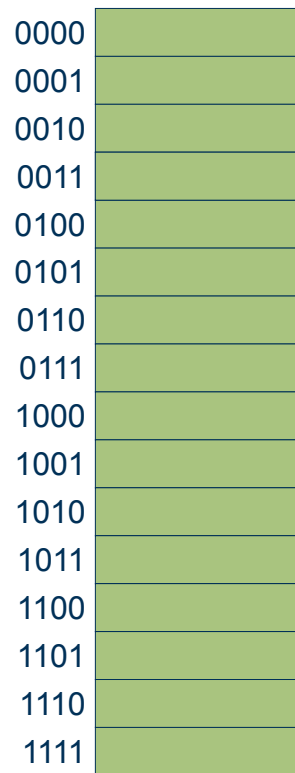

- 16 memory locations
- 4 cache locations
  - Also called **cache-line**
  - Every location has a valid bit, indicating whether that location contains valid data; 0 initially.
- For now, assume cache location size == memory location size == 1 B
- Assume each memory location can only reside in one cache-line

# A Simple Cache

Cache

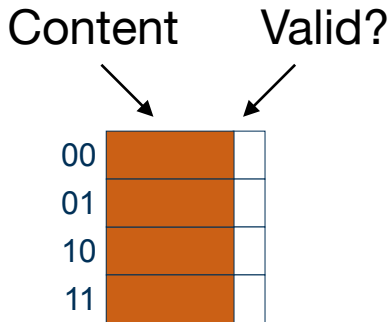

Memory

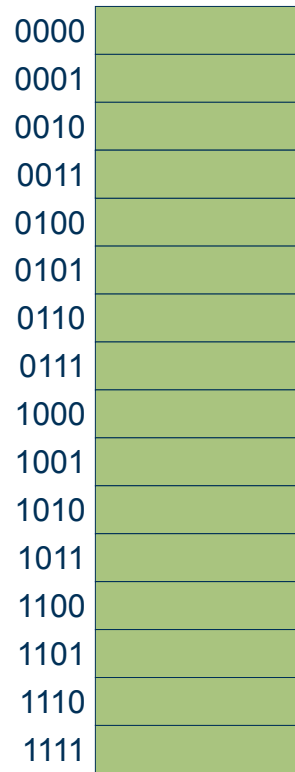

- 16 memory locations
- 4 cache locations
  - Also called **cache-line**
  - Every location has a valid bit, indicating whether that location contains valid data; 0 initially.
- For now, assume cache location size == memory location size == 1 B
- Assume each memory location can only reside in one cache-line
- Cache is smaller than memory (obviously)

# A Simple Cache

Cache

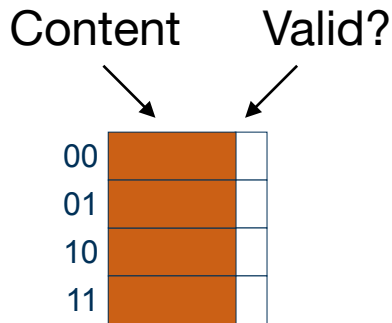

Memory

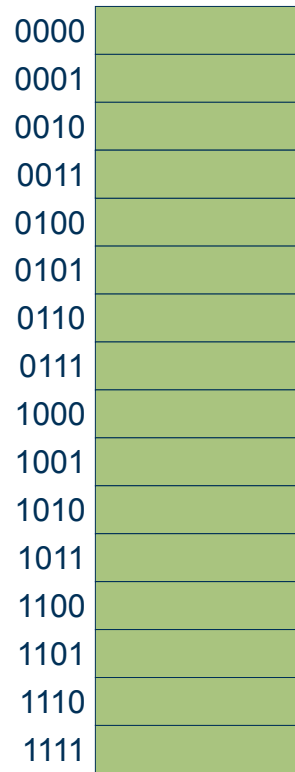

- 16 memory locations
- 4 cache locations
  - Also called **cache-line**
  - Every location has a valid bit, indicating whether that location contains valid data; 0 initially.
- For now, assume cache location size == memory location size == 1 B
- Assume each memory location can only reside in one cache-line
- Cache is smaller than memory (obviously)
  - Thus, not all memory locations can be cached at the same time

# Cache Placement

Cache

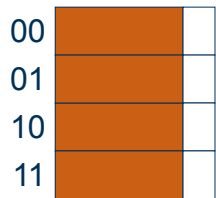

Memory

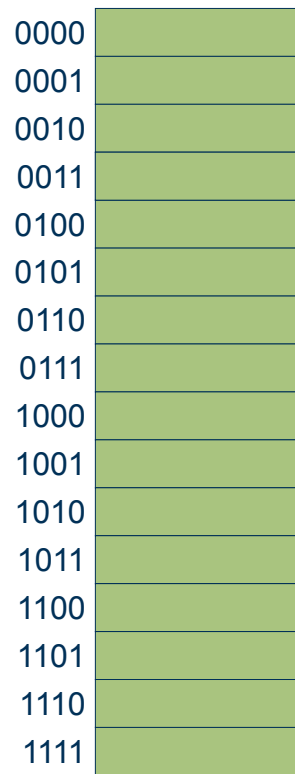

- Given a memory addr, say 0x0001, we want to put the data there into the cache; where does the data go?

# Function to Address Cache

Cache

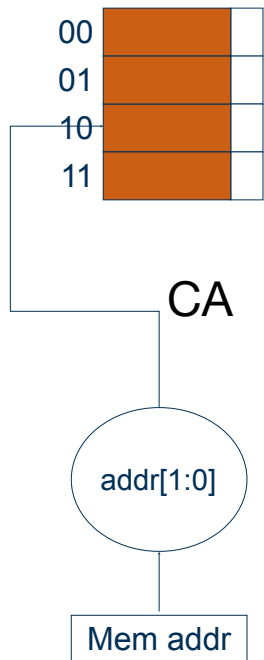

Memory

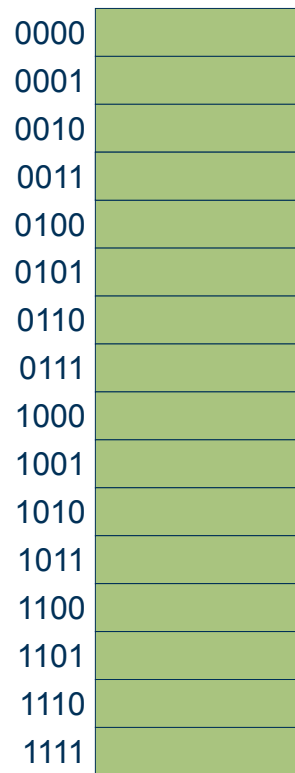

- Simplest way is to take a subset of address bits
- Six combinations in total
  - CA = ADDR[3],ADDR[2]
  - CA = ADDR[3],ADDR[1]
  - CA = ADDR[3],ADDR[0]
  - CA = ADDR[2],ADDR[1]
  - CA = ADDR[2],ADDR[0]
  - CA = ADDR[1],ADDR[0]
- Direct-Mapped Cache
  - CA = ADDR[1],ADDR[0]
- How about using ADDR[1],ADDR[0]?

# Direct-Mapped Cache

Cache

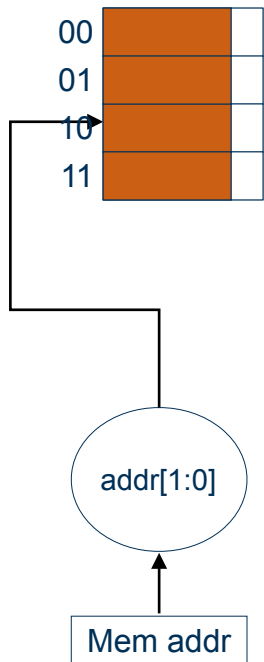

Memory

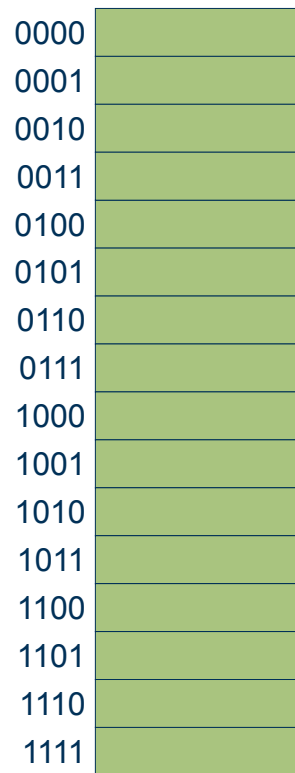

- Direct-Mapped Cache

- CA = ADDR[1],ADDR[0]
- Always use the lower order address bits

# Direct-Mapped Cache

Cache

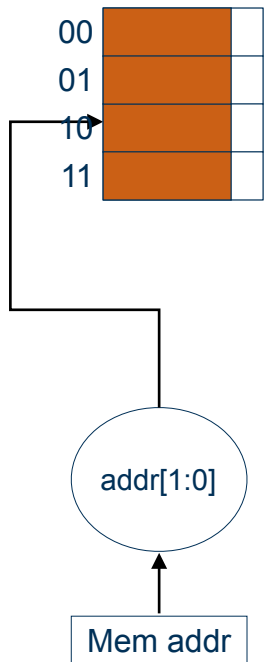

Memory

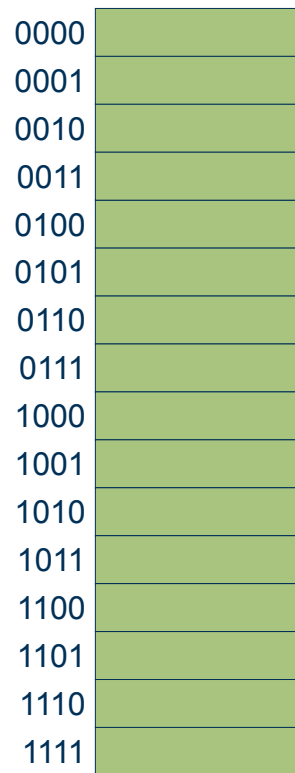

- Direct-Mapped Cache
  - $CA = ADDR[1], ADDR[0]$
  - Always use the lower order address bits
- Multiple addresses can be mapped to the same location

# Direct-Mapped Cache

Cache

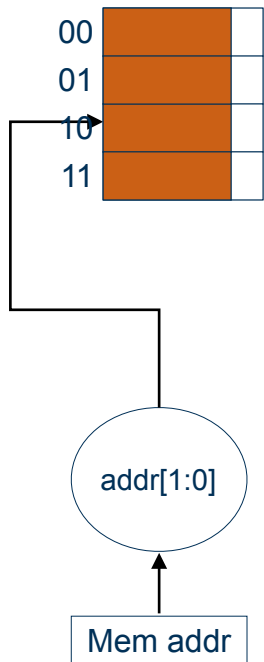

Memory

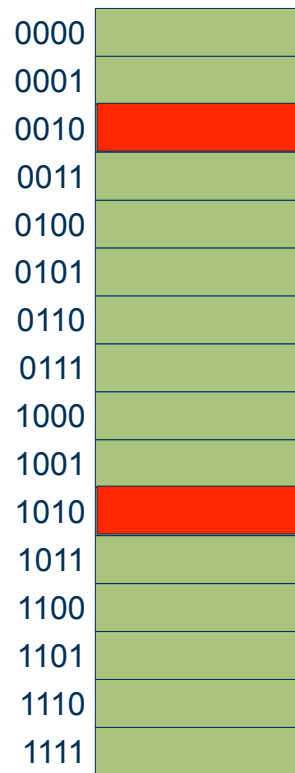

- **Direct-Mapped Cache**

- CA = ADDR[1],ADDR[0]
- Always use the lower order address bits

- **Multiple addresses can be mapped to the same location**

- E.g., 0010 and 1010



# Direct-Mapped Cache

Cache

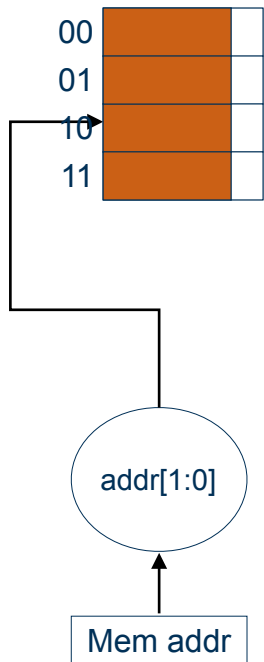

Memory

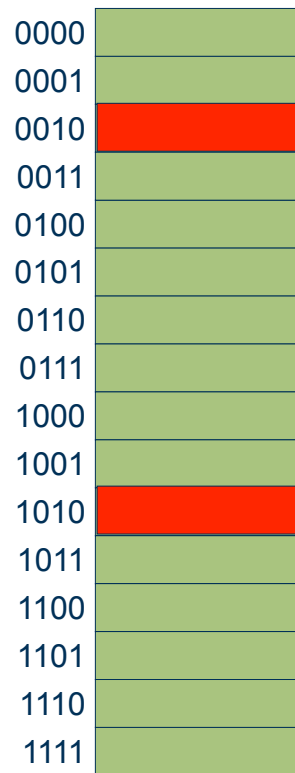

- Direct-Mapped Cache

- CA = ADDR[1],ADDR[0]
- Always use the lower order address bits

- Multiple addresses can be mapped to the same location

- E.g., 0010 and 1010

- How do we differentiate between different memory locations that are mapped to the same cache location?

# Direct-Mapped Cache

Cache

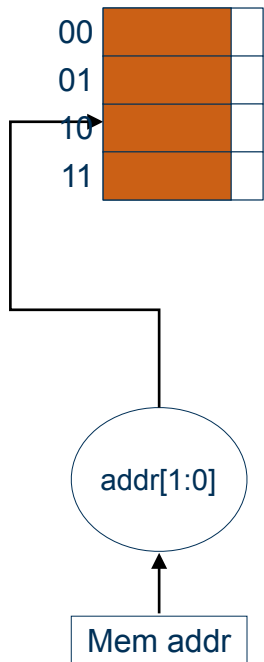

Memory

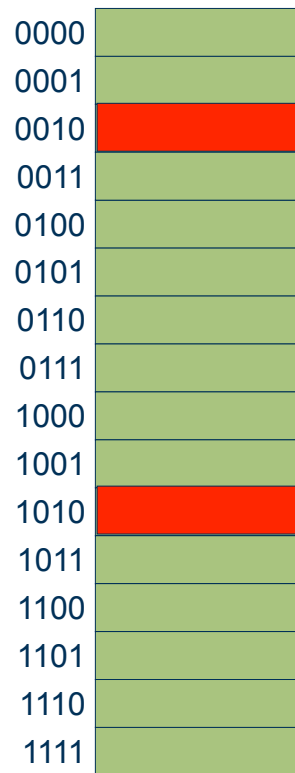

- Direct-Mapped Cache

- CA = ADDR[1],ADDR[0]
- Always use the lower order address bits

- Multiple addresses can be mapped to the same location

- E.g., 0010 and 1010

- How do we differentiate between different memory locations that are mapped to the same cache location?

- Add a tag field for that purpose

# Direct-Mapped Cache

Cache

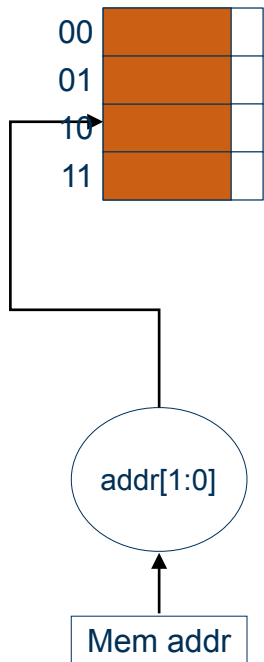

Memory

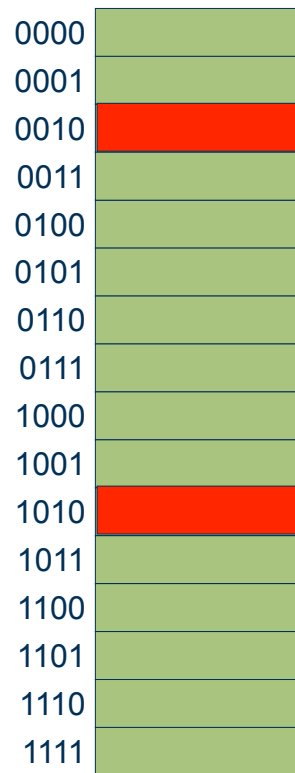

- Direct-Mapped Cache

- CA = ADDR[1],ADDR[0]
- Always use the lower order address bits

- Multiple addresses can be mapped to the same location

- E.g., 0010 and 1010

- How do we differentiate between different memory locations that are mapped to the same cache location?

- Add a tag field for that purpose
- What should the tag field be?

# Direct-Mapped Cache

Cache

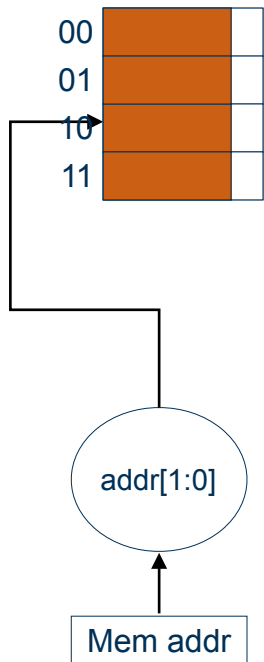

Memory

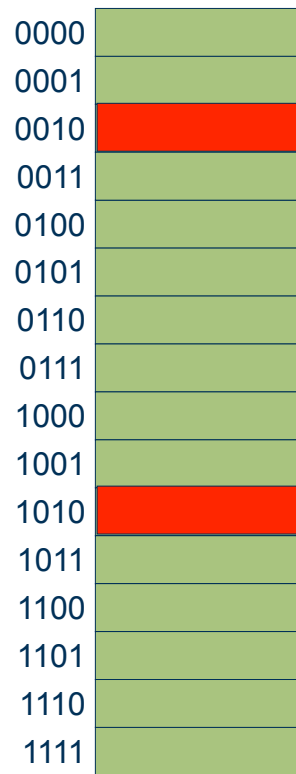

- **Direct-Mapped Cache**

- $CA = ADDR[1], ADDR[0]$
- Always use the lower order address bits

- **Multiple addresses can be mapped to the same location**

- E.g., 0010 and 1010

- **How do we differentiate between different memory locations that are mapped to the same cache location?**

- Add a tag field for that purpose
- What should the tag field be?
- $ADDR[3]$  and  $ADDR[2]$  in this particular example

# Direct-Mapped Cache

## Cache

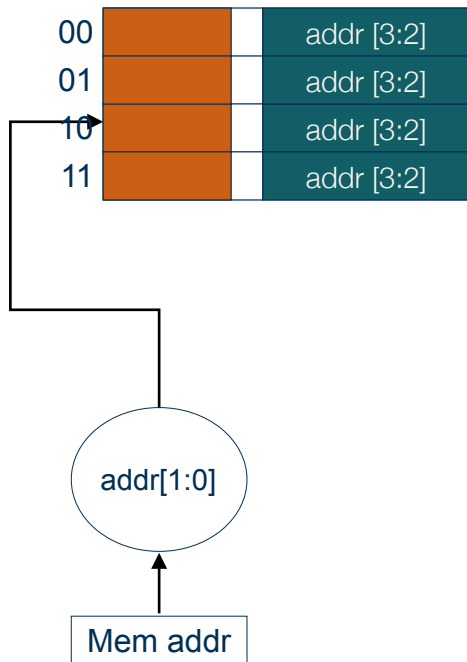

## Memory

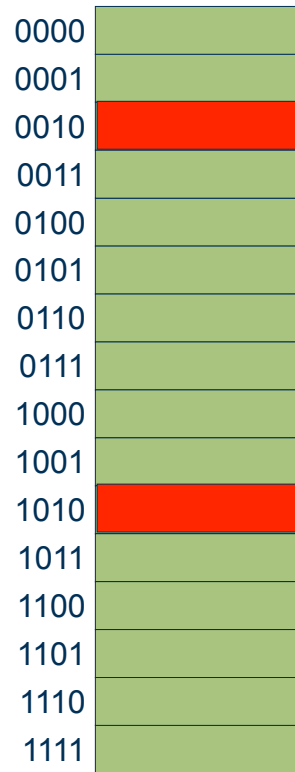

## • Direct-Mapped Cache

- $CA = ADDR[1], ADDR[0]$
- Always use the lower order address bits

## • Multiple addresses can be mapped to the same location

- E.g., 0010 and 1010

## • How do we differentiate between different memory locations that are mapped to the same cache location?

- Add a tag field for that purpose
- What should the tag field be?
- $ADDR[3]$  and  $ADDR[2]$  in this particular example

# Direct-Mapped Cache

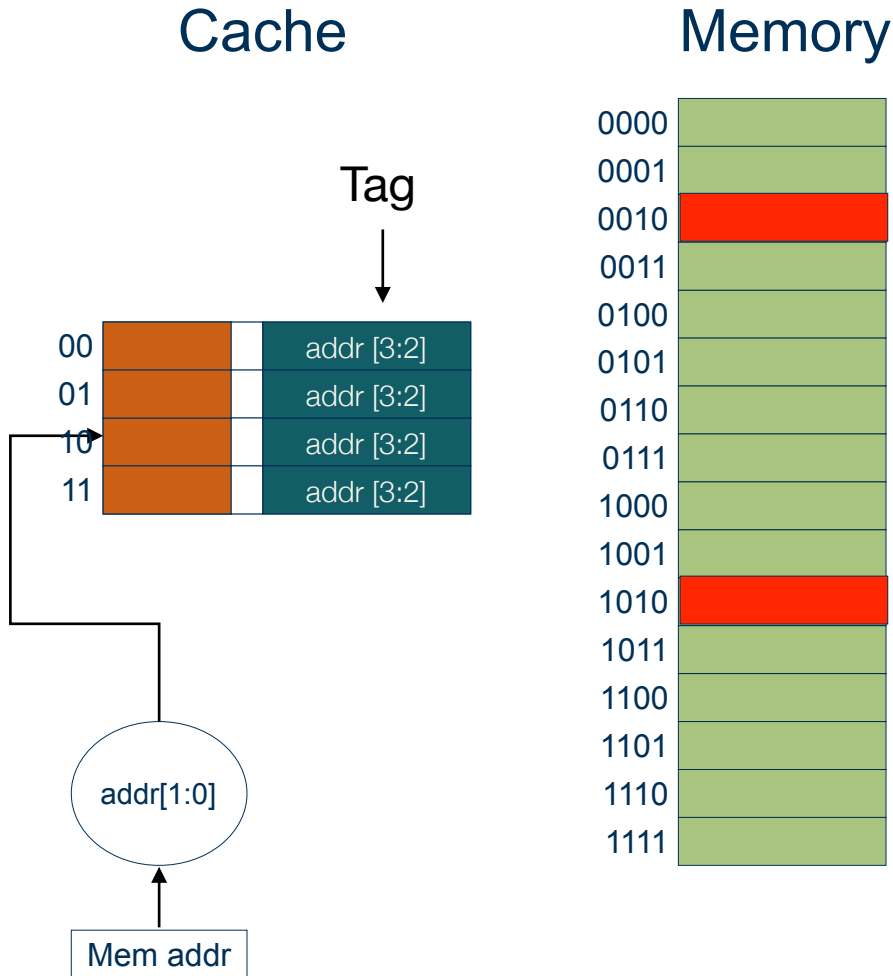

- Direct-Mapped Cache
  - $CA = ADDR[1], ADDR[0]$
  - Always use the lower order address bits
- Multiple addresses can be mapped to the same location
  - E.g., 0010 and 1010
- How do we differentiate between different memory locations that are mapped to the same cache location?
  - Add a tag field for that purpose
  - What should the tag field be?
  - $ADDR[3]$  and  $ADDR[2]$  in this particular example

# Direct-Mapped Cache

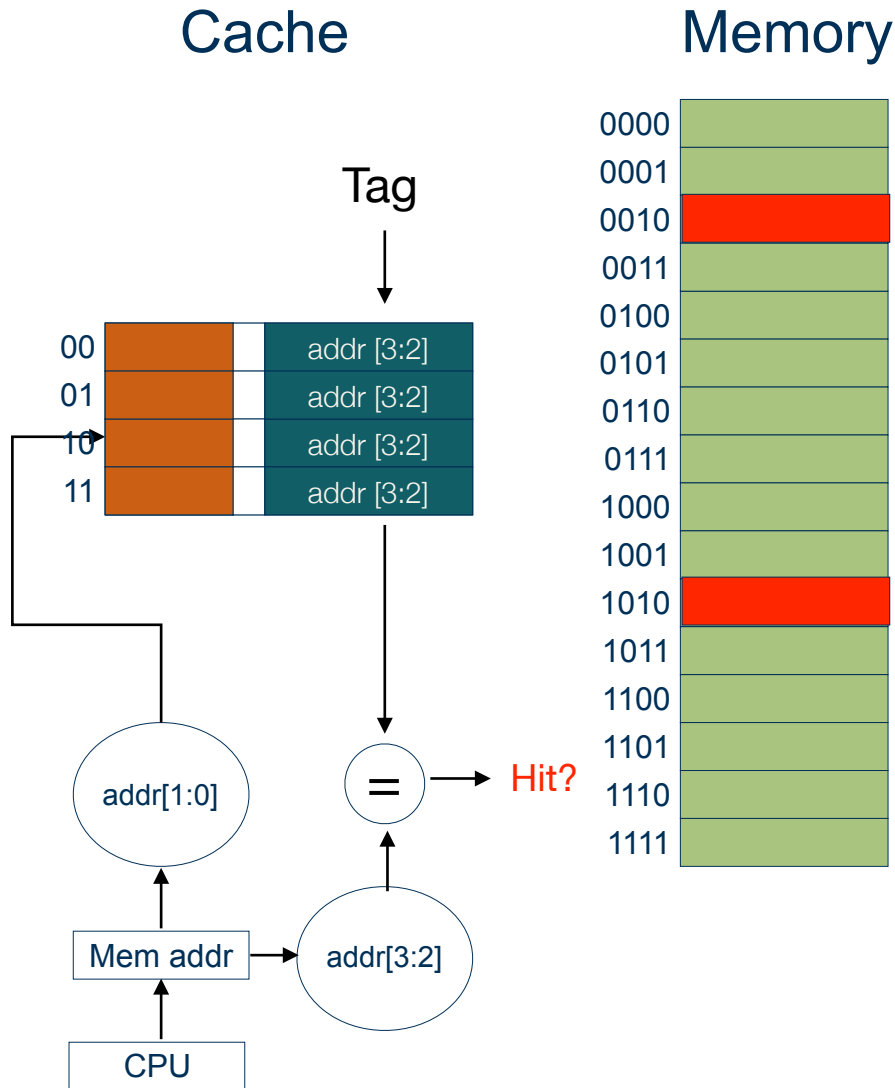

- **Direct-Mapped Cache**

- $CA = ADDR[1], ADDR[0]$
- Always use the lower order address bits

- **Multiple addresses can be mapped to the same location**

- E.g., 0010 and 1010

- **How do we differentiate between different memory locations that are mapped to the same cache location?**

- Add a tag field for that purpose
- What should the tag field be?
- $ADDR[3]$  and  $ADDR[2]$  in this particular example