

SPARC V7.0

Instruction Set

for Embedded Real time 32-bit Computer

(ERC32)

for SPACE Applications

Instruction Set

1. Assembly Language Syntax

The notations given in this section are taken from Sun's SPARC Assembler and are used to describe the suggested assembly language syntax for the instruction definitions given in Section 6.2.

Understanding the use of type fonts is crucial to understanding the assembly language syntax in the instruction definitions. Items in *typewriter* font are literals, to be entered exactly as they appear. Items in *italic* font are metasymbols that are to be replaced by numeric or symbolic values when actual assembly language code is written. For example, *asi* would be replaced by a number in the range of 0 to 255 (the value of the bits in the binary instruction), or by a symbol that has been bound to such a number.

Subscripts on metasymbols further identify the placement of the operand in the generated binary instruction. For example, *regrs2* is a *reg* (i.e., register name) whose binary value will end up in the *rs2* field of the resulting instruction.

1.1. Register Names

reg

A *reg* is an integer unit register. It can have a value of:

%0	through	%31	all integer registers
%g0	through	%g7	global registers—same as %0 through %7
%o0	through	%o7	out registers—same as %8 through %15
%l0	through	%l7	local registers—same as %16 through %23
%i0	through	%i7	in registers—same as %24 through %31

Subscripts further identify the placement of the operand in the binary instruction as one of the following:

<i>regrs1</i>	— <i>rs1</i> field
<i>regrs2</i>	— <i>rs2</i> field
<i>regrd</i>	— <i>rd</i> field

freg

A *freg* is a floating-point register. It can have a value from %f0 through %f31. Subscripts further identify the placement of the operand in the binary instruction as one of the following:

<i>fregrs1</i>	— <i>rs1</i> field
<i>fregrs2</i>	— <i>rs2</i> field
<i>fregrd</i>	— <i>rd</i> field

creg

A *creg* is a coprocessor register. It can have a value from %c0 through %c31. Subscripts further identify the placement of the operand in the binary instruction as one of the following:

<i>cregrs1</i>	— <i>rs1</i> field
<i>cregrs2</i>	— <i>rs2</i> field
<i>cregrd</i>	— <i>rd</i> field

1.2. Special Symbol Names

Certain special symbols need to be written exactly as they appear in the syntax table. These appear in *typewriter* font, and are preceded by a percent sign (%). The percent sign is part of the symbol name; it must appear as part of the literal value.

The symbol names are:

<code>%psr</code>	Processor State Register
<code>%wim</code>	Window Invalid Mask register
<code>%tbr</code>	Trap Base Register
<code>%y</code>	Y register
<code>%fsr</code>	Floating-point State Register
<code>%csr</code>	Coprocessor State Register
<code>%fq</code>	Floating-point Queue
<code>%cq</code>	Coprocessor Queue
<code>%hi</code>	Unary operator that extracts high 22 bits of its operand
<code>%lo</code>	Unary operator that extracts low 10 bits of its operand

1.3. Values

Some instructions use operands comprising values as follows:

simm13—A signed immediate constant that fits in 13 bits

const22—A constant that fits in 22 bits

asi—An alternate address space identifier (0 to 255)

1.4. Label

A label is a sequence of characters comprised of alphabetic letters (a–z, A–Z (upper and lower case distinct)), underscore (_), dollar sign (\$), period (.), and decimal digits (0–9), but which does not begin with a decimal digit.

Some instructions offer a choice of operands. These are grouped as follows:

regaddr:

reg rs1

reg rs1 + reg rs2

address:

reg rs1

reg rs1 + reg rs2

reg rs1 + simm13

reg rs1 - simm13

simm13

simm13 + reg rs1

reg_or_imm:

reg rs2

simm13

1.5. Instruction Mnemonics

Figure 1.1 illustrates the mnemonics used to describe the SPARC instruction set. Note that some combinations possible in *Figure 1.1* do not correspond to valid instructions (such as store signed or floating-point convert extended to extended). Refer to the instruction summary on page 6–6 for a list of valid SPARC instructions.

Data Transfer

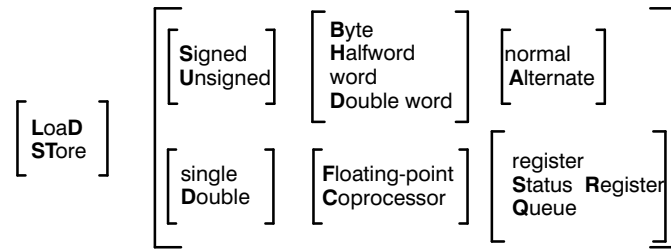

atomic **SWAP** word

atomic Load-Store **Unsigned Byte**

Integer Operations

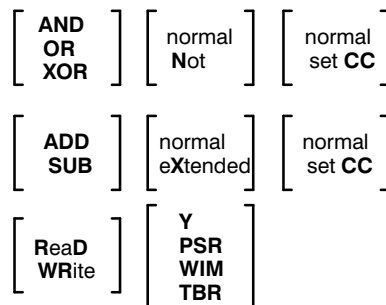

MULTiply Step set CC
SETHI
SAVE
RESTORE

Floating-Point Operations

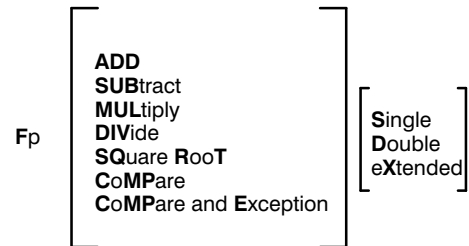
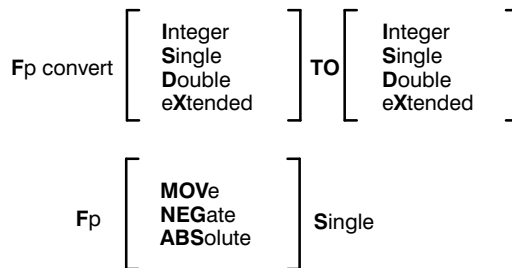

Control Transfer

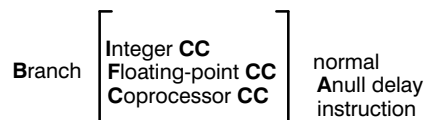

JuMP and Link
RETurn from Trap

CALL
Trap on Integer CC

Figure 1.1. SPARC Instruction Mnemonic Summary

2. Definitions

This section provides a detailed definition for each CY7C601 instruction. Each definition includes: the instruction operation; suggested assembly language syntax; a description of the salient features, restrictions and trap conditions; a list of synchronous or floating-point\coprocessor traps which can occur as a consequence of executing the instruction; and the instruction format and op codes. Instructions are defined in alphabetical order with the instruction mnemonic shown in large bold type at the top of the page for easy reference. The instruction set summary that precedes the definitions, (Table 1.2), groups the instructions by type.

Table 1.1 identifies the abbreviations and symbols used in the instruction definitions. An example of how some of the description notations are used is given below in Figure 1.2. Register names, labels and other aspects of the syntax used in these instructions are described in the previous section.

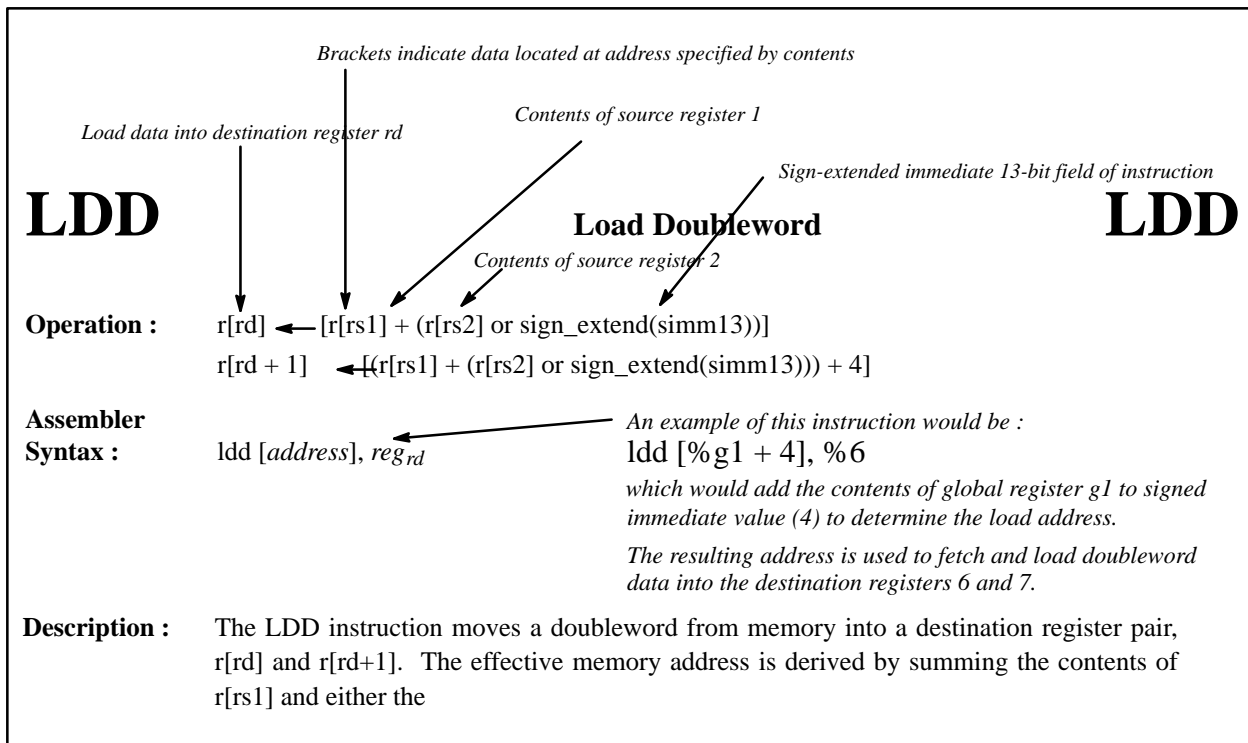

Figure 1.2. Instruction Description

Table 1.1. Instruction Description Notations

Symbol	Description
a	Instruction field that controls instruction annulling during control transfers
AND, OR XOR, etc.	AND, OR, XOR, etc operators
asr_reg	Any implemented ASR (Ancillary State)
c	The icc carry bit
ccc	The coprocessor condition code field of the CCSR
CONCAT	Concatenate
cond	Instruction field that selects the condition code test for branches

Symbol	Description
creg	Communication Coprocessor Register : can be %ccsr, %ccfr, %ccpr, %cccrc
CWP	PSR's Current Window Pointer field
disp22	Instruction field that contains the 22-bit sign-extended displacement for branches
disp30	Instruction field that contains the 30-bit word displacement for calls
EC	PSR's Enable Coprocessor bit
EF	PSR's Enable FPU bit
ET	PSR's Enable Traps bit
i	Instruction field that selects rs2 or sign_extend(simm13) as the second operand
icc	The integer condition code field of the PSR
imm22	Instruction field that contains the 22-bit constant used by SETHI
n	The icc negative bit
not	Logical complement operator
nPC	next Program Counter
opc	Instruction field that specifies the count for Coprocessor-operate instructions
operand2	Either r[rs2] or sign_extend(simm13)
PC	Program Counter
pS	PSR's previous Supervisor bit
PSR	Processor State Register
r[15]	A directly addressed register (could be floating-point or coprocessor)
rd	Instruction field that specifies the destination register (except for store)
r[rd]	Depending on context, the integer register (or its contents) specified by the instruction field, e.g. , rd, rs1, rs2
r[rd]<31>	<> are used to specify bit fields of a particular register or I/O signal
[r[rs1] + r[rs2]]	The contents of the address specified by r[rs1] + r[rs2]
rs1	Instruction field that specifies the source 1 register
rs2	Instruction field that specifies the source 2 register
S	PSR's Supervisor bit
shcnt	Instruction field that specifies the count for shift instructions
sign_extend(simm13)	Instruction field that contains the 13-bit, sign-extended immediate value
Symbol	Description
TBR	Trap Base Register
tt	TBR's trap type field
uf	Floating-point exception : underflow

Symbol	Description
v	The icc overflow bit
WIM	Window Invalid Mask register
Y	Y Register
z	The icc zero bit
-	Subtract
x	Multiply
/	Divide
<--	Replaced by
7FFFFFF H	Hexadecimal number representation
+	Add

Table 1.2. Instruction Set Summary

	Name	Operation	Cycles
Load and Store Instructions	LDSB(LDSBA*)	Load Signed Byte (from Alternate Space)	2
	LDSH(LDSHA*)	Load Signed Halfword (from Alternate Space)	2
	LDUB(LDUBA*)	Load Unsigned Byte (from Alternate Space)	2
	LDUH(LDUHA*)	Load Unsigned Halfword (from Alternate Space)	2
	LD(LDA*)	Load Word (from Alternate Space)	2
	LDD(LDDA*)	Load Doubleword (from Alternate Space)	3
	LDF	Load Floating Point	2
	LDDF	Load Double Floating Point	3
	LDFSR	Load Floating Point State Register	2
	LDC	Load Coprocessor	2
	LDDC	Load Double Coprocessor	3
	LDCSR	Load Coprocessor State Register	2
	STB(STBA*)	Store Byte (into Alternate Space)	3
	STH(STHA*)	Store Halfword (into Alternate Space)	3
	ST(STA*)	Store Word (into Alternate Space)	3
	STD(STDA*)	Store Doubleword (into Alternate Space)	4
	STF	Store Floating Point	3
	STDF	Store Double Floating Point	4
	STFSR	Store Floating Point State Register	3
	STDFQ*	Store Double Floating Point Queue	4
STC	Store Coprocessor	3	
STDC	Store Double Coprocessor	4	
STCSR	Store Coprocessor State Register	3	
STDCQ*	Store Double Coprocessor Queue	4	
LDSTUB(LDSTUBA*)	Atomic Load/Store Unsigned Byte (in Alternate Space)	4	
SWAP(SWAPA*)	Swap r Register with Memory (in Alternate Space)	4	
Arithmetic/Logical/Shift	ADD(ADDcc)	Add (and modify icc)	1
	ADDX(ADDXcc)	Add with Carry (and modify icc)	1
	TADDcc(TADDccTV)	Tagged Add and modify icc (and Trap on overflow)	1
	SUB(SUBcc)	Subtract (and modify icc)	1
	SUBX(SUBXcc)	Subtract with Carry (and modify icc)	1
	TSUBcc(TSUBccTV)	Tagged Subtract and modify icc (and Trap on overflow)	1
	MULScc	Multiply Step and modify icc	1
	AND(ANDcc)	And (and modify icc)	1
	ANDN(ANDNcc)	And Not (and modify icc)	1
	OR(ORcc)	Inclusive Or (and modify icc)	1
	ORN(ORNcc)	Inclusive Or Not (and modify icc)	1
	XOR(XORcc)	Exclusive Or (and modify icc)	1
	XNOR(XNORcc)	Exclusive Nor (and modify icc)	1
	SLL	Shift Left Logical	1
	SRL	Shift Right Logical	1
SRA	Shift Right Arithmetic	1	
SETHI	Set High 22 Bits of r Register	1	
SAVE	Save caller's window	1	
RESTORE	Restore caller's window	1	
Control Transfer	Bicc	Branch on Integer Condition Codes	1**
	FBicc	Branch on Floating Point Condition Codes	1**
	CBicc	Branch on Coprocessor Condition Codes	1**
	CALL	Call	1**
	JMPL	Jump and Link	2**
	RETT	Return from Trap	2**
	Ticc	Trap on Integer Condition Codes	1 (4 if Taken)
Read/Write Control Registers	RDY	Read Y Register	1
	RDPSR*	Read Processor State Register	1
	RDWIM*	Read Window Invalid Mask	1
	RDTBR*	Read Trap Base Register	1
	WRY	Write Y Register	1
	WRPSR*	Write Processor State Register	1
	WRWIM*	Write Window Invalid Mask	1
	WRTBR*	Write Trap Base Register	1
UNIMP	Unimplemented Instruction	1	
IFLUSH	Instruction Cache Flush	1	
FP (CP) Ops	FPop	Floating Point Unit Operations	1 to Launch
	CPop	Coprocessor Operations	1 to Launch

* privileged instruction

** assuming delay slot is filled with useful instruction

ADD

Add

ADD

Operation: $r[rd] \leftarrow r[rs1] + (r[rs2] \text{ or sign extnd}(\text{simm13}))$

Assembler

Syntax: `add reg_rs1, reg_or_imm, reg_rd`

Description: The ADD instruction adds the contents of the register named in the *rs1* field, $r[rs1]$, to either the contents of $r[rs2]$ if the instruction's *i* bit equals zero, or to the 13-bit, sign-extended immediate operand contained in the instruction if *i* equals one. The result is placed in the register specified in the *rd* field.

Traps: none

Format:



ADDcc

Add and modify icc

ADDcc

Operation: $r[rd] \leftarrow r[rs1] + \text{operand2}$, where $\text{operand2} = (r[rs2] \text{ or } \text{sign_extnd}(\text{simm13}))$
 $n \leftarrow r[rd]<31>$
 $z \leftarrow \text{if } r[rd] = 0 \text{ then } 1, \text{ else } 0$
 $v \leftarrow (r[rs1]<31> \text{ AND } \text{operand2}<31> \text{ AND not } r[rd]<31>)$
 OR (not $r[rs1]<31>$ AND not $\text{operand2}<31>$ AND $r[rd]<31>$)
 $c \leftarrow (r[rs1]<31> \text{ AND } \text{operand2}<31>)$
 OR (not $r[rd]<31>$ AND ($r[rs1]<31>$ OR $\text{operand2}<31>$))

Assembler

Syntax: `addcc reg_rs1, reg_or_imm, reg_rd`

Description: ADDcc adds the contents of $r[rs1]$ to either the contents of $r[rs2]$ if the instruction's i bit equals zero, or to a 13-bit, sign-extended immediate operand if i equals one. The result is placed in the register specified in the rd field. In addition, ADDcc modifies all the integer condition codes in the manner described above.

Traps: none

Format:

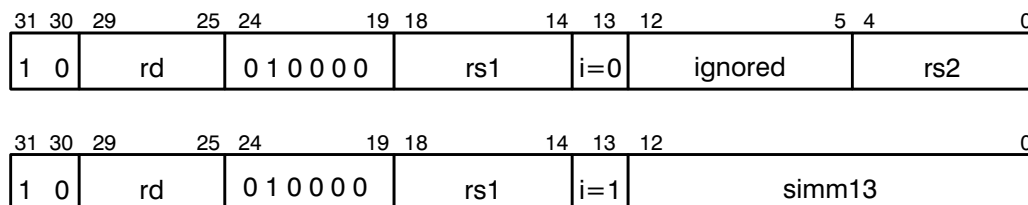

ADDX

Add with Carry

ADDX

Operation: $r[rd] \leftarrow r[rs1] + (r[rs2] \text{ or sign extnd(simm13)}) + c$

Assembler

Syntax: `addx reg_rs1, reg_or_imm, reg_rd`

Description: ADDX adds the contents of r[rs1] to either the contents of r[rs2] if the instruction's *i* bit equals zero, or to a 13-bit, sign-extended immediate operand if *i* equals one. It then adds the PSR's carry bit (*c*) to that result. The final result is placed in the register specified in the *rd* field.

Traps: none

Format:



ADDXcc

Add with Carry and modify icc

ADDXcc

Operation: $r[rd] \leftarrow r[rs1] + \text{operand2} + c$, where $\text{operand2} = (r[rs2] \text{ or sign extnd}(\text{simm13}))$
 $n \leftarrow r[rd]<31>$
 $z \leftarrow \text{if } r[rd]=0 \text{ then } 1, \text{ else } 0$
 $v \leftarrow (r[rs1]<31> \text{ AND } \text{operand2}<31> \text{ AND not } r[rd]<31>)$
 OR (not $r[rs1]<31>$ AND not $\text{operand2}<31>$ AND $r[rd]<31>$)
 $c \leftarrow (r[rs1]<31> \text{ AND } \text{operand2}<31>)$
 OR (not $r[rd]<31>$ AND ($r[rs1]<31>$ OR $\text{operand2}<31>$))

Assembler

Syntax: `addxcc reg_rs1, reg_or_imm, reg_rd`

Description: ADDXcc adds the contents of $r[rs1]$ to either the contents of $r[rs2]$ if the instruction's i bit equals zero, or to a 13-bit, sign-extended immediate operand if i equals one. It then adds the PSR's carry bit (c) to that result. The final result is placed in the register specified in the rd field. ADDXcc also modifies all the integer condition codes in the manner described above.

Traps: none

Format:



AND

And

AND

Operation: $r[rd] \leftarrow r[rs1] \text{ AND } (r[rs2] \text{ or sign extnd}(\text{simm13}))$

Assembler

Syntax: `and reg_rs1, reg_or_imm, reg_rd`

Description: This instruction does a bitwise logical AND of the contents of register r[rs1] with either the contents of r[rs2] (if if bit field i=0) or the 13-bit, sign-extended immediate value contained in the instruction (if if bit field i=1). The result is stored in register r[rd].

Traps: none

Format:

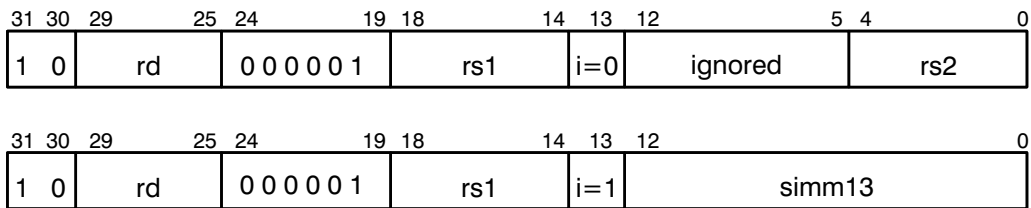

ANDcc

And and modify icc

ANDcc

Operation: $r[rd] \leftarrow r[rs1] \text{ AND } (r[rs2] \text{ or sign extnd(simm13)})$
 $n \leftarrow r[rd] < 31 >$
 $z \leftarrow \text{if } r[rd] = 0 \text{ then } 1, \text{ else } 0$
 $v \leftarrow 0$
 $c \leftarrow 0$

Assembler

Syntax: `andcc reg_rs1, reg_or_imm, reg_rd`

Description: This instruction does a bitwise logical AND of the contents of register r[rs1] with either the contents of r[rs2] (if if bit field i=0) or the 13-bit, sign-extended immediate value contained in the instruction (if if bit field i=1). The result is stored in register r[rd]. ANDcc also modifies all the integer condition codes in the manner described above.

Traps: none

Format:

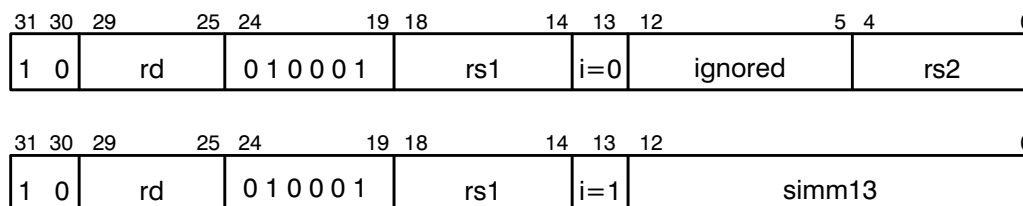

ANDN

And Not

ANDN

Operation: $r[rd] \leftarrow r[rs1] \text{ AND } \overline{(r[rs2] \text{ or sign extnd(simm13)})}$

Assembler

Syntax: `andn regrs1, reg_or_imm, regrd`

Description: ANDN does a bitwise logical AND of the contents of register r[rs1] with the logical compliment (not) of either r[rs2] (if if bit field i=0) or the 13-bit, sign-extended immediate value contained in the instruction (if if bit field i=1). The result is stored in register r[rd].

Traps: none

Format:

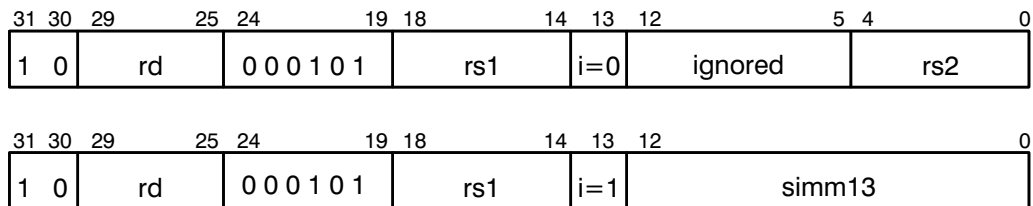

ANDNcc

And Not and modify icc

ANDNcc

Operation: $r[rd] \leftarrow r[rs1] \text{ AND } \overline{(r[rs2] \text{ or sign extnd}(simm13))}$
 $n \leftarrow r[rd] < 31 >$
 $z \leftarrow \text{if } r[rd] = 0 \text{ then } 1, \text{ else } 0$
 $v \leftarrow 0$
 $c \leftarrow 0$

Assembler

Syntax: `andncc reg_rs1, reg_or_imm, reg_rd`

Description: ANDNcc does a bitwise logical AND of the contents of register r[rs1] with the logical compliment (not) of either r[rs2] (if bit field i=0) or the 13-bit, sign-extended immediate value contained in the instruction (if bit field i=1). The result is stored in register r[rd]. ANDNcc also modifies all the integer condition codes in the manner described above.

Traps: none

Format:

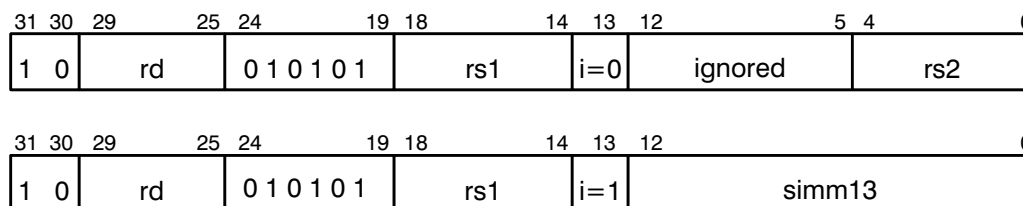

Bicc

Integer Conditional Branch

Bicc

Operation: $PC \leftarrow nPC$
 If condition true then $nPC \leftarrow PC + (\text{sign extnd}(\text{disp22}) \times 4)$
 else $nPC \leftarrow nPC + 4$

Assembler

Syntax:

$ba\{,a\}$	<i>label</i>	
$bn\{,a\}$	<i>label</i>	
$bne\{,a\}$	<i>label</i>	synonym: <i>bnz</i>
$be\{,a\}$	<i>label</i>	synonym: <i>bz</i>
$bg\{,a\}$	<i>label</i>	
$ble\{,a\}$	<i>label</i>	
$bge\{,a\}$	<i>label</i>	
$bl\{,a\}$	<i>label</i>	
$bgu\{,a\}$	<i>label</i>	
$bleu\{,a\}$	<i>label</i>	
$bcc\{,a\}$	<i>label</i>	synonym: <i>bgeu</i>
$bcs\{,a\}$	<i>label</i>	synonym: <i>blu</i>
$bpos\{,a\}$	<i>label</i>	
$bneg\{,a\}$	<i>label</i>	
$bvc\{,a\}$	<i>label</i>	
$bvs\{,a\}$	<i>label</i>	

Note: The instruction's annul bit field, *a*, is set by appending “,a” after the branch name. If it is not appended, the *a* field is automatically reset. “,a” is shown in braces because it is optional.

Description: The Bicc instructions (except for BA and BN) evaluate specific integer condition code combinations (from the PSR's *icc* field) based on the branch type as specified by the value in the instruction's *cond* field. If the specified combination of condition codes evaluates as true, the branch is taken, causing a delayed, PC-relative control transfer to the address $(PC + 4) + (\text{sign extnd}(\text{disp22}) \times 4)$. If the condition codes evaluate as false, the branch is not taken. Refer to Section NO TAG for additional information on control transfer instructions.

If the branch is not taken, the annul bit field (*a*) is checked. If *a* is set, the instruction immediately following the branch instruction (the delay instruction) *is not* executed (i.e., it is annulled). If the annul field is zero, the delay instruction *is* executed. If the branch is taken, the annul field is ignored, and the delay instruction is executed. See Section NO TAG regarding delay-branch instructions.

Branch Never (BN) executes like a NOP, except it obeys the annul field with respect to its delay instruction.

Branch Always (BA), because it always branches regardless of the condition codes, would normally ignore the annul field. Instead, it follows the same annul field rules: if $a=1$, the delay instruction is annulled; if $a=0$, the delay instruction is executed.

The delay instruction following a Bicc (other than BA) should not be a delayed-control-transfer instruction. The results of following a Bicc with another delayed control transfer instruction are implementation-dependent and therefore unpredictable.

Traps: none

Mnemonic	Cond.	Operation	icc Test
BN	0000	Branch Never	No test
BE	0001	Branch on Equal	z
BLE	0010	Branch on Less or Equal	z OR (n XOR v)
BL	0011	Branch on Less	n XOR v
BLEU	0100	Branch on Less or Equal, Unsigned	c OR z
BCS	0101	Branch on Carry Set (Less than, Unsigned)	c
BNEG	0110	Branch on Negative	n
BVS	0111	Branch on oVerflow Set	v
BA	1000	Branch Always	No test
BNE	1001	Branch on Not Equal	not z
BG	1010	Branch on Greater	not(z OR (n XOR v))
BGE	1011	Branch on Greater or Equal	not(n XOR v)
BGU	1100	Branch on Greater, Unsigned	not(c OR z)
BCC	1101	Branch on Carry Clear (Greater than or Equal, Unsigned)	not c
BPOS	1110	Branch on Positive	not n
BVC	1111	Branch on oVerflow Clear	not v

Format:

31	30	29	28	25	24	22	21	0
0	0	a	cond.	0	1	0	disp22	

CALL

Call

CALL

Operation: $r[15] \leftarrow PC$
 $PC \leftarrow nPC$
 $nPC \leftarrow PC + (disp30 \times 4)$

Assembler Syntax: `call label`

Description: The CALL instruction causes a delayed, unconditional, PC-relative control transfer to the address $(PC + 4) + (disp30 \times 4)$. The CALL instruction does not have an annul bit, therefore the delay slot instruction following the CALL instruction is always executed (See Section NO TAG). CALL first writes its return address (PC) into the *outs* register, r[15], and then adds 4 to the PC. The 32-bit displacement which is added to the new PC is formed by appending two low-order zeros to the 30-bit word displacement contained in the instruction. Consequently, the target address can be anywhere in the CY7C601's user or supervisor address space.

If the instruction following a CALL uses register r[15] as a source operand, hardware interlocks add a one cycle delay.

Programming note: a register-indirect CALL can be constructed using a JMPL instruction with *rd* set to 15.

Traps: none

Format:

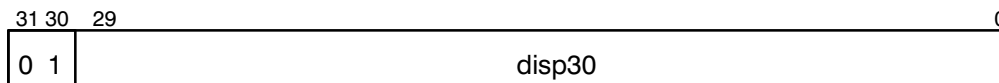

CBccc

Coprocessor Conditional Branch

CBccc

Operation: $PC \leftarrow nPC$
 If condition true then $nPC \leftarrow PC + (\text{sign extnd}(\text{disp22}) \times 4)$
 else $nPC \leftarrow nPC + 4$

Assembler

Syntax: *cba*{,a} *label*
 cbn{,a} *label*
 cb3{,a} *label*
 cb2{,a} *label*
 cb23{,a} *label*
 cb1{,a} *label*
 cb13{,a} *label*
 cb12{,a} *label*
 cb123{,a} *label*
 cb0{,a} *label*
 cb03{,a} *label*
 cb02{,a} *label*
 cb023{,a} *label*
 cb01{,a} *label*
 cb013{,a} *label*
 cb012{,a} *label*

Note: The instruction's annul bit field, *a*, is set by appending “,a” after the branch name. If it is not appended, the *a* field is automatically reset. “,a” is shown in braces because it is optional.

Description: The CBccc instructions (except for CBA and CBN) evaluate specific coprocessor condition code combinations (from the CCC<1:0> inputs) based on the branch type as specified by the value in the instruction's *cond* field. If the specified combination of condition codes evaluates as true, the branch is taken, causing a delayed, PC-relative control transfer to the address $(PC + 4) + (\text{sign extnd}(\text{disp22}) \times 4)$. If the condition codes evaluate as false, the branch is not taken. See Section NO TAG regarding control transfer instructions.

If the branch is not taken, the annul bit field (*a*) is checked. If *a* is set, the instruction immediately following the branch instruction (the delay instruction) *is not* executed (i.e., it is annulled). If the annul field is zero, the delay instruction *is* executed. If the branch is taken, the annul field is ignored, and the delay instruction is executed. See Section NO TAG regarding delayed branching.

Branch Never (CBN) executes like a NOP, except it obeys the annul field with respect to its delay instruction.

Branch Always (CBA), because it always branches regardless of the condition codes, would normally ignore the annul field. Instead, it follows the same annul field rules: if *a*=1, the delay instruction is annulled; if *a*=0, the delay instruction is executed.

To prevent misapplication of the condition codes, a non-coprocessor instruction must immediately precede a CBccc instruction.

A CBccc instruction generates a cp_disabled trap (and does not branch or annul) if the PSR's EC bit is reset or if no coprocessor is present.

Traps: cp_disabled
cp_exception

Mnemonic	cond.	CCC<1:0> test
CBN	0000	Never
CB123	0001	1 or 2 or 3
CB12	0010	1 or 2
CB13	0011	1 or 3
CB1	0100	1
CB23	0101	2 or 3
CB2	0110	2
CB3	0111	3
CBA	1000	Always
CB0	1001	0
CB03	1010	0 or 3
CB02	1011	0 or 2
CB023	1100	0 or 2 or 3
CB01	1101	0 or 1
CB013	1110	0 or 1 or 3
CB012	1111	0 or 1 or 2

Format:

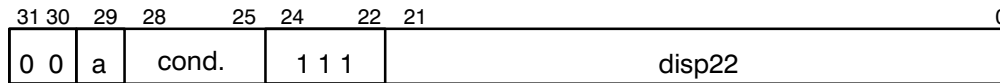

CPop

Coprocessor Operate

CPop

Operation: Dependent on Coprocessor implementation

Assembler Syntax: Unspecified

Description: CPop1 and CPop2 are the instruction formats for coprocessor operate instructions. The *op3* field for CPop1 is 110110; for CPop2 it's 110111. The coprocessor operations themselves are encoded in the *opc* field and are dependent on the coprocessor implementation. Note that this does not include load/store coprocessor instructions, which fall into the integer unit's load/store instruction category.

All CPop instructions take all operands from, and return all results to, the coprocessor's registers. The data types supported, how the operands are aligned, and whether a CPop generates a *cp_exception* trap are Coprocessor dependent.

A CPop instruction causes a *cp_disabled* trap if the PSR's EC bit is reset or if no coprocessor is present.

Traps: *cp_disabled*
cp_exception

Format:

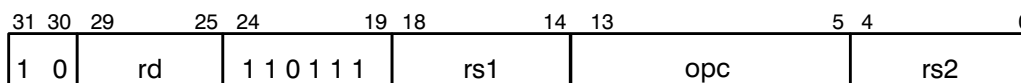
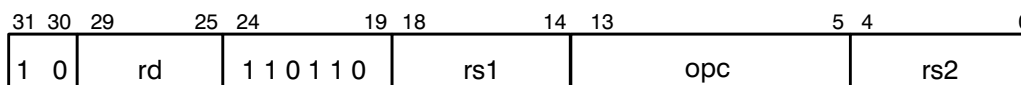

FABSs

Absolute Value Single (FPU Instruction Only)

FABSs

Operation: $f[rd]_s \leftarrow f[rs2]_s \text{ AND } 7FFFFFFF H$

Assembler

Syntax: `fabss regrs2, regrd`

Description: The FABSs instruction clears the sign bit of the word in f[rs2] and places the result in f[rd]. It does not round.

Since rs2 can be either an even or odd register, FABSs can also operate on the high-order words of double and extended operands, which accomplishes sign bit clear for these data types.

Traps: fp_disabled
fp_exception*

Format:

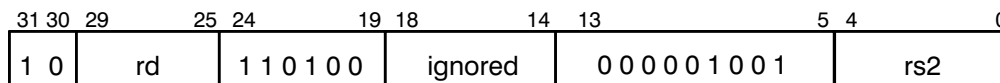

* NOTE: An attempt to execute any FP instruction will cause a pending FP exception to be recognized by the integer unit.

FADDd

Add Double

FADDd

(FPU Instruction Only)

Operation: $f[rd]d \leftarrow f[rs1]d + f[rs2]d$

Assembler

Syntax: `faddd fregrs1, fregrs2, fregrd`

Description: The FADDd instruction adds the contents of f[rs1] CONCAT f[rs1+1] to the contents of f[rs2] CONCAT f[rs2+1] as specified by the ANSI/IEEE 754-1985 standard and places the results in f[rd] and f[rd+1].

Traps: fp_disabled
fp_exception (of, uf, nv, nx)

Format:

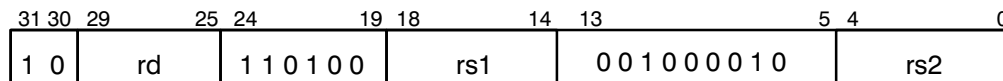

FADDs

Add Single

FADDs

(FPU Instruction Only)

Operation: $f[rd]s \leftarrow f[rs1]s + f[rs2]s$

Assembler

Syntax: `fadds fregrs1, fregrs2, fregrd`

Description: The FADDs instruction adds the contents of f[rs1] to the contents of f[rs2] as specified by the ANSI/IEEE 754-1985 standard and places the results in f[rd].

Traps: fp_disabled
fp_exception (of, uf, nv, nx)

Format:

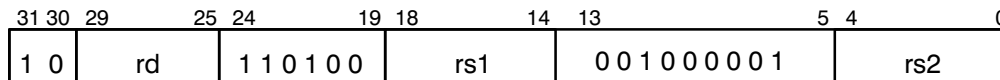

FADDx

Add Extended

FADDx

(FPU Instruction Only)

Operation: $f[rd]_x \leftarrow f[rs1]_x + f[rs2]_x$

Assembler

Syntax: `faddx fregrs1, fregrs2, fregrd`

Description: The FADDx instruction adds the contents of f[rs1] CONCAT f[rs1+1] CONCAT f[rs1+2] to the contents of f[rs2] CONCAT f[rs2+1] CONCAT f[rs2+2] as specified by the ANSI/IEEE 754-1985 standard and places the results in f[rd], f[rd+1], and f[rd+2].

Traps: fp_disabled
fp_exception (of, uf, nv, nx)

Format:

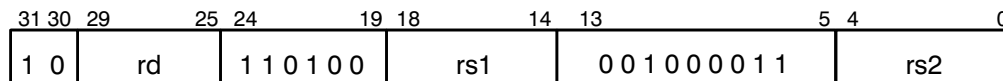

FBfcc

Floating-Point Conditional Branch

FBfcc

Operation: $PC \leftarrow nPC$
 If condition true then $nPC \leftarrow PC + (\text{sign extnd}(\text{disp22}) \times 4)$
 else $nPC \leftarrow nPC + 4$

Assembler

Syntax:

<code>fba{,a}</code>	<i>label</i>	
<code>fbn{,a}</code>	<i>label</i>	
<code>fbu{,a}</code>	<i>label</i>	
<code>fbg{,a}</code>	<i>label</i>	
<code>fbug{,a}</code>	<i>label</i>	
<code>fbl{,a}</code>	<i>label</i>	
<code>fbul{,a}</code>	<i>label</i>	
<code>fblg{,a}</code>	<i>label</i>	
<code>fbne{,a}</code>	<i>label</i>	synonym: <code>fbnz</code>
<code>fbe{,a}</code>	<i>label</i>	synonym: <code>fbz</code>
<code>fbue{,a}</code>	<i>label</i>	
<code>fbge{,a}</code>	<i>label</i>	
<code>fbuge{,a}</code>	<i>label</i>	
<code>fble{,a}</code>	<i>label</i>	
<code>fbule{,a}</code>	<i>label</i>	
<code>fbo{,a}</code>	<i>label</i>	

Note: The instruction's annul bit field, *a*, is set by appending “,a” after the branch name. If it is not appended, the *a* field is automatically reset. “,a” is shown in braces because it is optional.

Description: The FBfcc instructions (except for FBA and FBN) evaluate specific floating-point condition code combinations (from the FCC<1:0> inputs) based on the branch type, as specified by the value in the instruction's *cond* field. If the specified combination of condition codes evaluates as true, the branch is taken, causing a delayed, PC-relative control transfer to the address $(PC + 4) + (\text{sign extnd}(\text{disp22}) \times 4)$. If the condition codes evaluate as false, the branch is not taken. See Section NO TAG for additional information on control transfer instructions.

If the branch is not taken, the annul bit field (*a*) is checked. If *a* is set, the instruction immediately following the branch instruction (the delay instruction) *is not* executed (i.e., it is annulled). If the annul field is zero, the delay instruction *is* executed. If the branch is taken, the annul field is ignored, and the delay instruction is executed. See Section NO TAG regarding delayed branch instructions.

Branch Never (FBN) executes like a NOP, except it obeys the annul field with respect to its delay instruction.

Branch Always (FBA), because it always branches regardless of the condition codes, would normally ignore the annul field. Instead, it follows the same annul field rules: if *a*=1, the delay instruction is annulled; if *a*=0, the delay instruction is executed.

To prevent misapplication of the condition codes, a non-floating-point instruction must immediately precede an FBfcc instruction.

An FBfcc instruction generates an `fp_disabled` trap (and does not branch or annul) if the PSR's EF bit is reset or if no Floating-Point Unit is present.

Traps: fp_disabled
fp_exception*

Mnemonic	Cond.	Operation	fcc Test
FBN	0000	Branch Never	no test
FBNE	0001	Branch on Not Equal	U or L or G
FBLG	0010	Branch on Less or Greater	L or G
FBUL	0011	Branch on Unordered or Less	U or L
FBL	0100	Branch on Less	L
FBUG	0101	Branch on Unordered or Greater	U or G
FBG	0110	Branch on Greater	G
FBU	0111	Branch on Unordered	U
FBA	1000	Branch Always	no test
FBE	1001	Branch on Equal	E
FBUE	1010	Branch on Unordered or Equal	U or E
FBGE	1011	Branch on Greater or Equal	G or E
FBUGE	1100	Branch on Unordered or Greater or Equal	U or G or E
FBLE	1101	Branch on Less or Equal	L or E
FBULE	1110	Branch on Unordered or Less or Equal	U or L or E
FBO	1111	Branch on Ordered	L or G or E

Format:

31	30	29	28	25	24	22	21	0
0	0	a	cond.	1	1	0	disp22	

* NOTE: An attempt to execute any FP instruction will cause a pending FP exception to be recognized by the integer unit.

FCMPd

Compare Double

FCMPd

(FPU Instruction Only)

Operation: $fcc \leftarrow f[rs1]d \text{ COMPARE } f[rs2]d$

Assembler

Syntax: `fcmpd freqrs1, freqrs2`

Description: FCMPd subtracts the contents of $f[rs2]$ CONCAT $f[rs2+1]$ from the contents of $f[rs1]$ CONCAT $f[rs1+1]$ following the ANSI/IEEE 754-1985 standard. The result is evaluated, the FSR's *fcc* bits are set accordingly, and then the result is discarded. The codes are set as follows:

fcc	relation
0	$fs1 = fs2$
1	$fs1 < fs2$
2	$fs1 > fs2$
3	$fs1 ? fs2$ (unordered)

In this table, *fs1* stands for the contents of $f[rs1]$, $f[rs1+1]$ and *fs2* represents the contents of $f[rs2]$, $f[rs2+1]$.

Compare instructions are used to set up the floating-point condition codes for a subsequent FBfcc instruction. However, to prevent misapplication of the condition codes, at least one non-floating-point instruction must be executed between an FCMP and a subsequent FBfcc instruction.

FCMPd causes an invalid exception (nv) if either operand is a signaling NaN.

Traps: `fp_disabled`
`fp_exception (nv)`

Format:

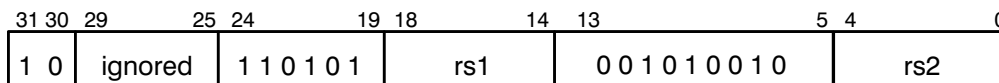

FCMPEd Compare Double and Exception if Unordered FCMPEd

(FPU Instruction Only)

Operation: $fcc \leftarrow f[rs1]_d \text{ COMPARE } f[rs2]_d$

Assembler

Syntax: `fcmped regrs1, regrs2`

Description: FCMPEd subtracts the contents of $f[rs2]$ CONCAT $f[rs2+1]$ from the contents of $f[rs1]$ CONCAT $f[rs1+1]$ following the ANSI/IEEE 754-1985 standard. The result is evaluated, the FSR's *fcc* bits are set accordingly, and then the result is discarded. The codes are set as follows:

fcc	Relation
0	$fs1 = fs2$
1	$fs1 < fs2$
2	$fs1 > fs2$
3	$fs1 ? fs2$ (unordered)

In this table, $fs1$ stands for the contents of $f[rs1]$, $f[rs1+1]$ and $fs2$ represents the contents of $f[rs2]$, $f[rs2+1]$.

Compare instructions are used to set up the floating-point condition codes for a subsequent FBfcc instruction. However, to prevent misapplication of the condition codes, at least one non-floating-point instruction must be executed between an FCMP and a subsequent FBfcc instruction.

FCMPEd causes an invalid exception (nv) if either operand is a signaling or quiet NaN.

Traps: `fp_disabled`
`fp_exception (nv)`

Format:

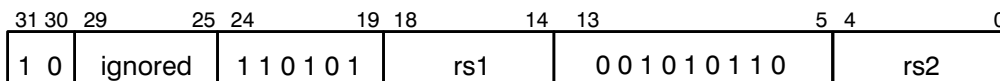

FCMPEs Compare Single and Exception if Unordered FCMPEs

(FPU Instruction Only)

Operation: $fcc \leftarrow f[rs1]_s \text{ COMPARE } f[rs2]_s$

Assembler

Syntax: `fcmpes freqrs1, freqrs2`

Description: FCMPEs subtracts the contents of f[rs2] from the contents of f[rs1] following the ANSI/IEEE 754-1985 standard. The result is evaluated, the FSR's *fcc* bits are set accordingly, and then the result is discarded. The codes are set as follows:

fcc	Relation
0	fs1 = fs2
1	fs1 < fs2
2	fs1 > fs2
3	fs1 ? fs2 (unordered)

In this table, fs1 stands for the contents of f[rs1] and fs2 represents the contents of f[rs2].

Compare instructions are used to set up the floating-point condition codes for a subsequent FBfcc instruction. However, to prevent misapplication of the condition codes, at least one non-floating-point instruction must be executed between an FCMP and a subsequent FBfcc instruction.

FCMPEs causes an invalid exception (nv) if either operand is a signaling or quiet NaN.

Traps: fp_disabled
fp_exception (nv)

Format:

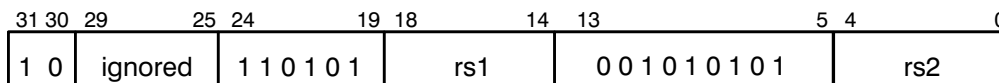

FCMPE_X Compare Extended and Exception if Unordered **FCMPE**
X

(FPU Instruction Only)

Operation: $fcc \leftarrow f[rs1]_x \text{ COMPARE } f[rs2]_x$

Assembler

Syntax: `fcmpex freqrs1, freqrs2`

Description: FCMPE_X subtracts the contents of $f[rs2]$ CONCAT $f[rs2+1]$ CONCAT $f[rs2+2]$ from the contents of $f[rs1]$ CONCAT $f[rs1+1]$ CONCAT $f[rs1+2]$ following the ANSI/IEEE 754-1985 standard. The result is evaluated, the FSR's *fcc* bits are set accordingly, and then the result is discarded. The codes are set as follows:

fcc	Relation
0	$fs1 = fs2$
1	$fs1 < fs2$
2	$fs1 > fs2$
3	$fs1 ? fs2$ (unordered)

In this table, *fs1* stands for the contents of $f[rs1]$, $f[rs1+1]$, $f[rs1+2]$ and *fs2* represents the contents of $f[rs2]$, $f[rs2+1]$, $f[rs2+2]$.

Compare instructions are used to set up the floating-point condition codes for a subsequent FBfcc instruction. However, to prevent misapplication of the condition codes, at least one non-floating-point instruction must be executed between an FCMP and a subsequent FBfcc instruction.

FCMPE_X causes an invalid exception (nv) if either operand is a signaling or quiet NaN.

Traps: `fp_disabled`
`fp_exception (nv)`

Format:

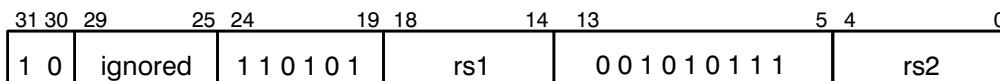

FCMPs

Compare Single

FCMPs

(FPU Instruction Only)

Operation: $fcc \leftarrow f[rs1]_s \text{ COMPARE } f[rs2]_s$

Assembler

Syntax: `fcmps regrs1, regrs2`

Description: FCMPs subtracts the contents of f[rs2] from the contents of f[rs1] following the ANSI/IEEE 754-1985 standard. The result is evaluated, the FSR's *fcc* bits are set accordingly, and then the result is discarded. The codes are set as follows:

fcc	Relation
0	fs1 = fs2
1	fs1 < fs2
2	fs1 > fs2
3	fs1 ? fs2 (unordered)

In this table, fs1 stands for the contents of f[rs1] and fs2 represents the contents of f[rs2].

Compare instructions are used to set up the floating-point condition codes for a subsequent FBfcc instruction. However, to prevent misapplication of the condition codes, at least one non-floating-point instruction must be executed between an FCMP and a subsequent FBfcc instruction.

FCMPs causes an invalid exception (nv) if either operand is a signaling NaN.

Traps:

fp_disabled
fp_exception (nv)

Format:

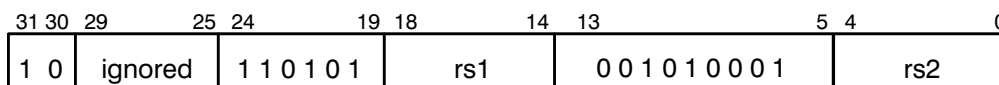

FCMPx

Compare Extended

FCMPx

(FPU Instruction Only)

Operation: $f_{cc} \leftarrow f[rs1]_x \text{ COMPARE } f[rs2]_x$

Assembler

Syntax: `fcmpx freqrs1, freqrs2`

Description: FCMPx subtracts the contents of f[rs2] CONCAT f[rs2+1] CONCAT f[rs2+2] from the contents of f[rs1] CONCAT f[rs1+1] CONCAT f[rs1+2] following the ANSI/IEEE 754-1985 standard. The result is evaluated, the FSR's *fcc* bits are set accordingly, and then the result is discarded. The codes are set as follows:

fcc	Relation
0	fs1 = fs2
1	fs1 < fs2
2	fs1 > fs2
3	fs1 ? fs2 (unordered)

In this table, fs1 stands for the contents of f[rs1], f[rs1+1], f[rs1+2] and fs2 represents the contents of f[rs2], f[rs2+1], f[rs2+2].

Compare instructions are used to set up the floating-point condition codes for a subsequent FBfcc instruction. However, to prevent misapplication of the condition codes, at least one non-floating-point instruction must be executed between an FCMP and a subsequent FBfcc instruction.

FCMPx causes an invalid exception (nv) if either operand is a signaling NaN.

Traps: fp_disabled
fp_exception (nv)

Format:

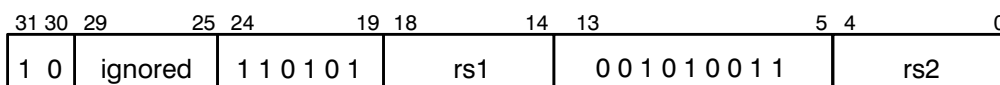

FDIVd

Divide Double

FDIVd

(FPU Instruction Only)

Operation: $f[rd]d \leftarrow f[rs1]d / f[rs2]d$

Assembler

Syntax: `fdivd fregrs1, fregrs2, fregrd`

Description: The FDIVd instruction divides the contents of f[rs1] CONCAT f[rs1+1] by the contents of f[rs2] CONCAT f[rs2+1] as specified by the ANSI/IEEE 754-1985 standard and places the results in f[rd] and f[rd+1].

Traps: fp_disabled
fp_exception (of, uf, dz, nv, nx)

Format:

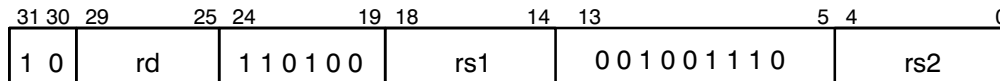

FDIVs

Divide Single

FDIVs

(FPU Instruction Only)

Operation: $f[rd]_s \leftarrow f[rs1]_s / f[rs2]_s$

Assembler

Syntax: `fdivs regrs1, regrs2, regrd`

Description: The FDIVs instruction divides the contents of f[rs1] by the contents of f[rs2] as specified by the ANSI/IEEE 754-1985 standard and places the results in f[rd].

Traps: fp_disabled
fp_exception (of, uf, dz, nv, nx)

Format:

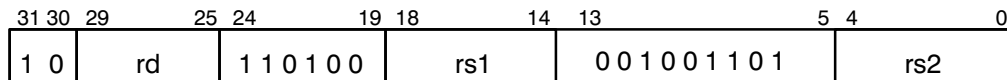

FDIV_x

Divide Extended

FDIV_x

(FPU Instruction Only)

Operation: $f[rd]_x \leftarrow f[rs1]_x / f[rs2]_x$

Assembler

Syntax: `fdivx freqrs1, freqrs2, freqrd`

Description: The FDIV_x instruction divides the contents of f[rs1] CONCAT f[rs1+1] CONCAT f[rs1+2] by the contents of f[rs2] CONCAT f[rs2+1] CONCAT f[rs2+2] as specified by the ANSI/IEEE 754-1985 standard and places the results in f[rd], f[rd+1], and f[rd+2].

Traps: fp_disabled
fp_exception (of, uf, dz, nv, nx)

Format:

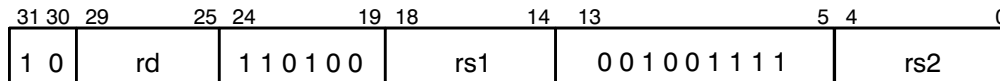

FdTOi

Convert Double to Integer

FdTOi

(FPU Instruction Only)

Operation: $f[rd]i \leftarrow f[rs2]d$

Assembler

Syntax: `fdtoi fregrs2, fregrd`

Description: FdTOi converts the floating-point double contents of f[rs2] CONCAT f[rs2+1] to a 32-bit, signed integer by rounding toward zero as specified by the ANSI/IEEE 754-1985 standard. The result is placed in f[rd]. The rounding direction field (*RD*) of the FSR is ignored.

Traps: fp_disabled
fp_exception (nv, nx)

Format:

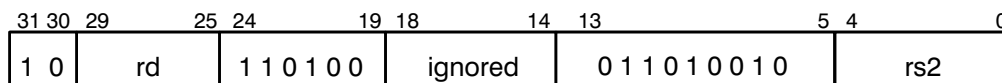

FdTOs

Convert Double to Single (FPU Instruction Only)

FdTOs

Operation: $f[rd]s \leftarrow f[rs2]d$

Assembler

Syntax: `fdtos freqrs2, freqrd`

Description: FdTOs converts the floating-point double contents of f[rs2] CONCAT f[rs2+1] to a single-precision, floating-point format as specified by the ANSI/IEEE 754-1985 standard. The result is placed in f[rd]. Rounding is performed according to the rounding direction field (*RD*) of the FSR.

Traps: fp_disabled
fp_exception (of, uf, nv, nx)

Format:

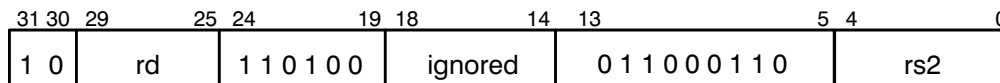

FdTOx

Convert Double to Extended

FdTOx

(FPU Instruction Only)

Operation: $f[rd]_x \leftarrow f[rs2]_d$

Assembler

Syntax: `fdtox regrs2, regrd`

Description: FdTOx converts the floating-point double contents of f[rs2] CONCAT f[rs2+1] to an extended-precision, floating-point format as specified by the ANSI/IEEE 754-1985 standard. The result is placed in f[rd], f[rd+1], and f[rd+2]. Rounding is performed according to the rounding direction (*RD*) and rounding precision (*RP*) fields of the FSR.

Traps: fp_disabled
fp_exception (nv)

Format:

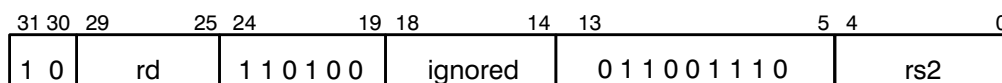

FiTOd

**Convert Integer to Double
(FPU Instruction Only)**

FiTOd

Operation: $f[rd]d \leftarrow f[rs2]i$

Assembler

Syntax: `fitod fregrs2, fregrd`

Description: FiTOd converts the 32-bit, signed integer contents of f[rs2] to a floating-point, double-precision format as specified by the ANSI/IEEE 754-1985 standard. The result is placed in f[rd] and f[rd+1].

Traps: fp_disabled
fp_exception*

Format:

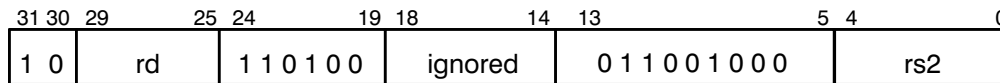

* NOTE: An attempt to execute any FP instruction will cause a pending FP exception to be recognized by the integer unit.

FiTOs

**Convert Integer to Single
(FPU Instruction Only)**

FiTOs

Operation: $f[rd]_s \leftarrow f[rs2]_i$

Assembler

Syntax: `fitos fregrs2, fregrd`

Description: FiTOs converts the 32-bit, signed integer contents of `f[rs2]` to a floating-point, single-precision format as specified by the ANSI/IEEE 754-1985 standard. The result is placed in `f[rd]`. Rounding is performed according to the rounding direction field, *RD*.

Traps: `fp_disabled`
`fp_exception (nx)`

Format:

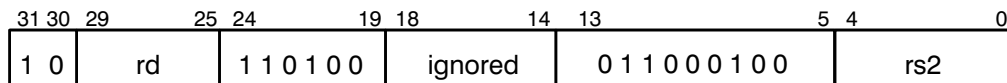

FiTOx

**Convert Integer to Extended
(FPU Instruction Only)**

FiTOx

Operation: $f[rd]x \leftarrow f[rs2]i$

Assembler

Syntax: `fitox fregrs2, fregrd`

Description: FiTOx converts the 32-bit, signed integer contents of f[rs2] to an extended-precision, floating-point format as specified by the ANSI/IEEE 754-1985 standard. The result is placed in f[rd], f[rd+1], and f[rd+2].

Traps: fp_disabled
fp_exception*

Format:

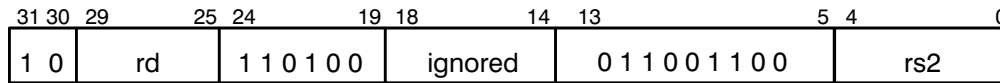

* NOTE: An attempt to execute any FP instruction will cause a pending FP exception to be recognized by the integer unit.

FMOV_s

Move

FMOV_s

(FPU Instruction Only)

Operation: $f[rd]_s \leftarrow f[rs2]_s$

Assembler

Syntax: `fmovs fregrs2, fregrd`

Description: The FMOV_s instruction moves the word content of register f[rs2] to the register f[rd]. Multiple FMOV_s's are required to transfer multiple-precision numbers between *f* registers.

Traps: fp_disabled
fp_exception*

Format:

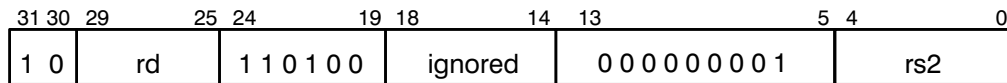

* NOTE: An attempt to execute any FP instruction will cause a pending FP exception to be recognized by the integer unit.

FMULd

Multiply Double

FMULd

(FPU Instruction Only)

Operation: $f[rd]d \leftarrow f[rs1]d \times f[rs2]d$

Assembler

Syntax: `fmuld fregrs1, fregrs2, fregrd`

Description: The FMULd instruction multiplies the contents of f[rs1] CONCAT f[rs1+1] by the contents of f[rs2] CONCAT f[rs2+1] as specified by the ANSI/IEEE 754-1985 standard and places the results in f[rd] and f[rd+1].

Traps: fp_disabled
fp_exception (of, uf, nv, nx)

Format:

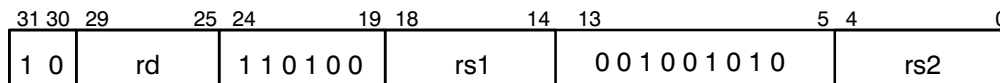

FMULS

Multiply Single

FMULS

(FPU Instruction Only)

Operation: $f[rd]_s \leftarrow f[rs1]_s \times ([rs2]_s)$

Assembler

Syntax: `fmuls fregrs1, fregrs2, fregrd`

Description: The FMULS instruction multiplies the contents of f[rs1] by the contents of f[rs2] as specified by the ANSI/IEEE 754-1985 standard and places the results in f[rd].

Traps: fp_disabled
fp_exception (of, uf, nv, nx)

Format:

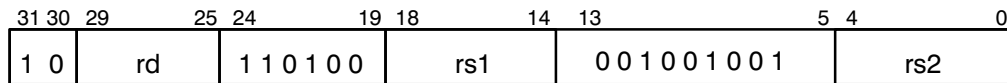

FMULx

Multiply Extended

FMULx

(FPU Instruction Only)

Operation: $f[rd]_x \leftarrow f[rs1]_x \times f[rs2]_x$

Assembler

Syntax: `fmulx fregrs1, fregrs2, fregrd`

Description: The FMULx instruction multiplies the contents of f[rs1] CONCAT f[rs1+1] CONCAT f[rs1+2] by the contents of f[rs2] CONCAT f[rs2+1] CONCAT f[rs2+2] as specified by the ANSI/IEEE 754-1985 standard and places the results in f[rd], f[rd+1], and f[rd+2].

Traps: fp_disabled
fp_exception (of, uf, nv, nx)

Format:

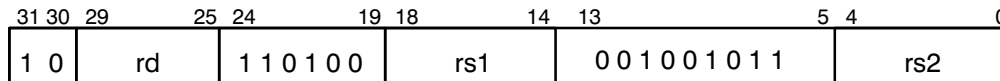

FNEGs

Negate

FNEGs

(FPU Instruction Only)

Operation: $f[rd]s \leftarrow f[rs2]s \text{ XOR } 80000000 \text{ H}$

Assembler

Syntax: `fnegs fregrs2, fregrd`

Description: The FNEGs instruction complements the sign bit of the word in f[rs2] and places the result in f[rd]. It does not round.

Since this FPop can address both even and odd *f* registers, FNEGs can also operate on the high-order words of double and extended operands, which accomplishes sign bit negation for these data types.

Traps: fp_disabled
fp_exception*

Format:

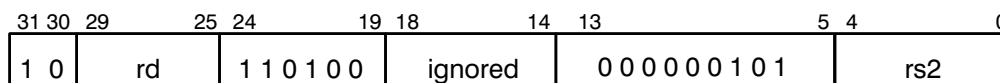

* NOTE: An attempt to execute any FP instruction will cause a pending FP exception to be recognized by the integer unit.

FSQRTd

Square Root Double
(FPU Instruction Only)

FSQRTd

Operation: $f[rd]d \leftarrow \text{SQRT } f[rs2]d$

Assembler

Syntax: `fsqrt regrs2, regrd`

Description: FSQRTd generates the square root of the floating-point double contents of f[rs2] CONCAT f[rs2+1] as specified by the ANSI/IEEE 754-1985 standard. The result is placed in f[rd] and f[rd+1]. Rounding is performed according to the rounding direction field (*RD*) of the FSR.

Traps: fp_disabled
fp_exception (nv, nx)

Format:

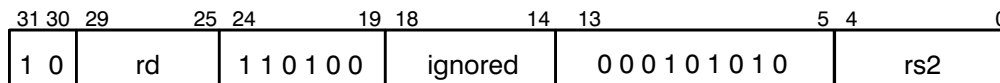

FSQRTs

Square Root Single (FPU Instruction Only)

FSQRTs

Operation: $f[rd]s \leftarrow \text{SQRT } f[rs2]s$

Assembler

Syntax: `fsqrts regrs2, regrd`

Description: FSQRTs generates the square root of the floating-point single contents of $f[rs2]$ as specified by the ANSI/IEEE 754-1985 standard. The result is placed in $f[rd]$. Rounding is performed according to the rounding direction field (*RD*) of the FSR.

Traps: `fp_disabled`
`fp_exception (nv, nx)`

Format:

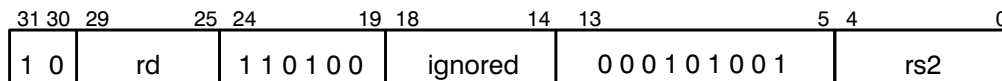

FSQRTx

Square Root Extended
(FPU Instruction Only)

FSQRTx

Operation: $f[rd]_x \leftarrow \text{SQRT } f[rs2]_x$

Assembler

Syntax: `fsqrtx fregrs2, fregrd`

Description: FSQRTx generates the square root of the floating-point extended contents of f[rs2] CONCAT f[rs2+1] CONCAT f[rs2+2] as specified by the ANSI/IEEE 754-1985 standard. The result is placed in f[rd], f[rd+1], and f[rd+2]. Rounding is performed according to the rounding direction (*RD*) and rounding precision (*RP*) fields of the FSR.

Traps: fp_disabled
fp_exception (nv, nx)

Format:

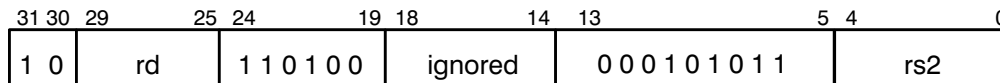

FsTOd

**Convert Single to Double
(FPU Instruction Only)**

FsTOd

Operation: $f[rd]d \leftarrow f[rs2]s$

Assembler

Syntax: `fstod regrs2, regrd`

Description: FsTOd converts the floating-point single contents of f[rs2] to a double-precision, floating-point format as specified by the ANSI/IEEE 754-1985 standard. The result is placed in f[rd] and f[rd+1]. Rounding is performed according to the rounding direction field (*RD*) of the FSR.

Traps: fp_disabled
fp_exception (nv)

Format:

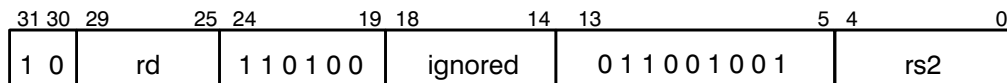

FsTOi

Convert Single to Integer
(FPU Instruction Only)

FsTOi

Operation: $f[rd]_i \leftarrow f[rs2]_s$

Assembler

Syntax: `fstoi fregrs2, fregrd`

Description: FsTOi converts the floating-point single contents of f[rs2] to a 32-bit, signed integer by rounding toward zero as specified by the ANSI/IEEE 754-1985 standard. The result is placed in f[rd]. The rounding field (RD) of the FSR is ignored.

Traps: fp_disabled
fp_exception (nv, nx)

Format:

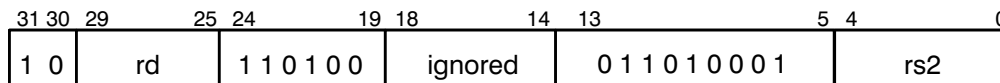

FsTOx

Convert Single to Extended

FsTOx

(FPU Instruction Only)

Operation: $f[rd]_x \leftarrow f[rs2]_s$

Assembler

Syntax: `fstox reg_rs2, reg_rd`

Description: FsTOx converts the floating-point single contents of f[rs2] to an extended-precision, floating-point format as specified by the ANSI/IEEE 754-1985 standard. The result is placed in f[rd], f[rd+1], and f[rd+2]. Rounding is performed according to the rounding direction (*RD*) and rounding precision (*RP*) fields of the FSR.

Traps: fp_disabled
fp_exception (nv)

Format:

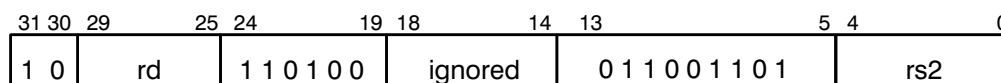

FSUBd

Subtract Double

FSUBd

(FPU Instruction Only)

Operation: $f[rd]d \leftarrow f[rs1]d - f[rs2]d$

Assembler

Syntax: `fsubd freqrs1, freqrs2, freqrd`

Description: The FSUBd instruction subtracts the contents of f[rs2] CONCAT f[rs2+1] from the contents of f[rs1] CONCAT f[rs1+1] as specified by the ANSI/IEEE 754-1985 standard and places the results in f[rd] and f[rd+1].

Traps: fp_disabled
fp_exception (of, uf, nx, nv)

Format:

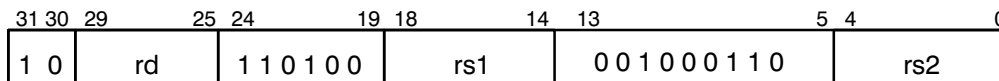

FSUBS

Subtract Single

FSUBS

(FPU Instruction Only)

Operation: $f[rd]_s \leftarrow f[rs1]_s - f[rs2]_s$

Assembler

Syntax: `fsubs regrs1, regrs2, regrd`

Description: The FSUBS instruction subtracts the contents of f[rs2] from the contents of f[rs1] as specified by the ANSI/IEEE 754-1985 standard and places the results in f[rd].

Traps: fp_disabled
fp_exception (of, uf, nx, nv)

Format:

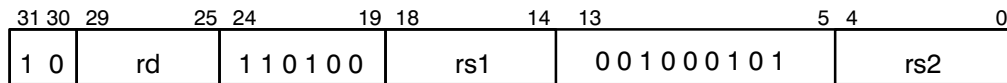

FSUBx

Subtract Extended

FSUBx

(FPU Instruction Only)

Operation: $f[rd]_x \leftarrow f[rs1]_x - f[rs2]_x$

Assembler

Syntax: `fsubx freqrs1, freqrs2, freqrd`

Description: The FSUBx instruction subtracts the contents of f[rs2] CONCAT f[rs2+1] CONCAT f[rs2+2] from the contents of f[rs1] CONCAT f[rs1+1] CONCAT f[rs1+2] as specified by the ANSI/IEEE 754-1985 standard and places the results in f[rd], f[rd+1], and f[rd+2].

Traps: fp_disabled
fp_exception (of, uf, nv, nx)

Format:

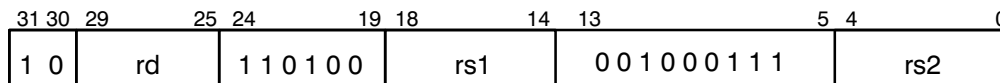

FxTOd

Convert Extended to Double

FxTOd

(FPU Instruction Only)

Operation: $f[rd]d \leftarrow f[rs2]x$

Assembler

Syntax: `fxtod freqrs2, freqrd`

Description: FxTOd converts the floating-point extended contents of f[rs2] CONCAT f[rs2+1] CONCAT f[rs2+2] to a double-precision, floating-point format as specified by the ANSI/IEEE 754-1985 standard. The result is placed in f[rd] and f[rd+1]. Rounding is performed according to the rounding direction (*RD*) field of the FSR.

Traps: fp_disabled
fp_exception (of, uf, nv, nx)

Format:

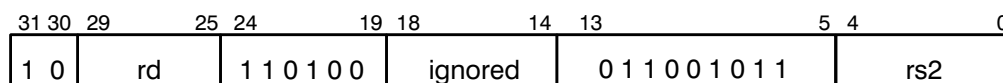

FxTOi

**Convert Extended to Integer
(FPU Instruction Only)**

FxTOi

Operation: $f[rd]i \leftarrow f[rs2]x$

Assembler

Syntax: `fxtoi regrs2, regrd`

Description: FxTOi converts the floating-point extended contents of f[rs2] CONCAT f[rs2+1] CONCAT f[rs2+2] to a 32-bit, signed integer by rounding toward zero as specified by the ANSI/IEEE 754-1985 standard. The result is placed in f[rd]. The rounding field (*RD*) of the FSR is ignored.

Traps: fp_disabled
fp_exception (nv, nx)

Format:

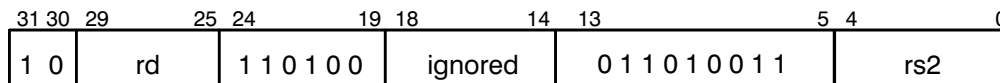

FxTOS

**Convert Extended to Single
(FPU Instruction Only)**

FxTOS

Operation: $f[rd]s \leftarrow f[rs2]x$

Assembler

Syntax: `fxtos reg_rs2, reg_rd`

Description: FxTOS converts the floating-point extended contents of f[rs2] CONCAT f[rs2+1] CONCAT f[rs2+2] to a single-precision, floating-point format as specified by the ANSI/IEEE 754-1985 standard. The result is placed in f[rd]. Rounding is performed according to the rounding direction (*RD*) field of the FSR.

Traps: fp_disabled
fp_exception (of, uf, nv, nx)

Format:

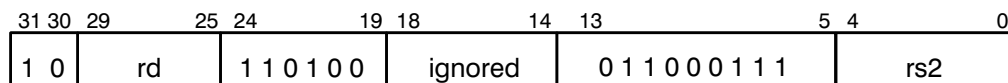

IFLUSH

Instruction Cache Flush

IFLUSH

Operation: FLUSH ← [r[rs1] + (r[rs2] or sign extnd(simm13))]

Assembler

Syntax: iflush *address*

Description: The IFLUSH instruction causes a word to be flushed from an instruction cache which may be internal to the processor. The word to be flushed is at the address specified by the contents of r[rs1] plus either the contents of r[rs2] if the instruction's *i* bit equals zero, or the 13-bit, sign-extended immediate operand contained in the instruction if *i* equals one.

Since there is no internal instruction cache in the current CY7C600 family, the result of executing an IFLUSH instruction is dependent on the state of the input signal, Instruction Cache Flush Trap (\overline{IFT}). If $\overline{IFT} = 1$, IFLUSH executes as a NOP, with no side effects. If $\overline{IFT} = 0$, execution of IFLUSH causes an illegal_instruction trap.

Traps: illegal_instruction

Format:



JMPL

Jump and Link

JMPL

Operation: $r[rd] \leftarrow PC$
 $PC \leftarrow nPC$
 $nPC \leftarrow r[rs1] + (r[rs2] \text{ or sign extnd}(simm13))$

Assembler

Syntax: `jmp address, regrd`

Description: JMPL first provides linkage by saving its return address into the register specified in the *rd* field. It then causes a register-indirect, delayed control transfer to an address specified by the sum of the contents of *r[rs1]* and either the contents of *r[rs2]* if the instruction's *i* bit equals zero, or the 13-bit, sign-extended immediate operand contained in the instruction if *i* equals one.

If either of the low-order two bits of the jump address is nonzero, a `memory_address_not_aligned` trap is generated.

Programming note: A register-indirect CALL can be constructed using a JMPL instruction with *rd* set to 15. JMPL can also be used to return from a CALL. In this case, *rd* is set to 0 and the return (jump) address would be equal to $r[31] + 8$.

Traps: `memory_address_not_aligned`

Format:

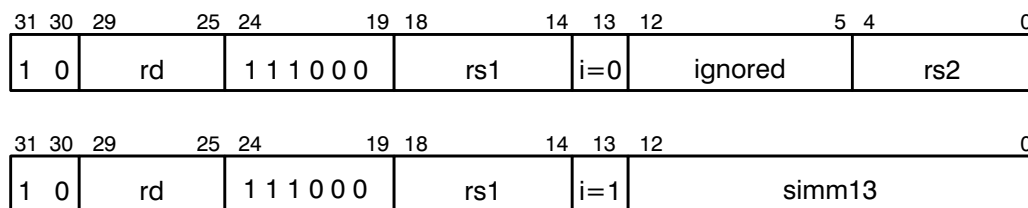

LD

Load Word

LD

Operation: $r[rd] \leftarrow [r[rs1] + (r[rs2] \text{ or sign extnd}(simm13))]$

Assembler

Syntax: `ld [address], regrd`

Description: The LD instruction moves a word from memory into the destination register, r[rd]. The effective memory address is derived by summing the contents of r[rs1] and either the contents of r[rs2] if the instruction's *i* bit equals zero, or the 13-bit, sign-extended immediate operand contained in the instruction if *i* equals one.

If LD takes a trap, the contents of the destination register remain unchanged.

If the instruction following an integer load uses the load's r[rd] register as a source operand, hardware interlocks add one or more delay cycles to the following instruction depending upon the memory subsystem.

Programming note: If *rs1* is set to 0 and *i* is set to 1, any location in the lowest or highest 4 kbytes of an address space can be accessed without setting up a register.

Traps: `memory_address_not_aligned`
`data_access_exception`

Format:

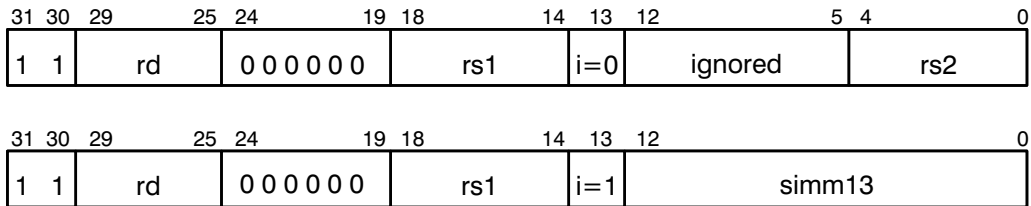

LDA

Load Word from Alternate space

LDA

(Privileged Instruction)

Operation: address space \leftarrow asi
 $r[rd] \leftarrow [r[rs1] + r[rs2]]$

Assembler

Syntax: lda [*regaddr*] asi, *regrd*

Description: The LDA instruction moves a word from memory into the destination register, r[rd]. The effective memory address is a combination of the address space value given in the *asi* field and the address derived by summing the contents of r[rs1] and r[rs2].

If LDA takes a trap, the contents of the destination register remain unchanged.

If the instruction following an integer load uses the load's r[rd] register as a source operand, hardware interlocks add one or more delay cycles to the following instruction depending upon the memory subsystem.

Traps: illegal_instruction (if i=1)
 privileged_instruction (if S=0)
 memory_address_not_aligned
 data_access_exception

Format:

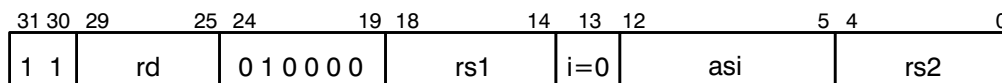

LDC

Load Coprocessor register

LDC

Operation: $c[rd] \leftarrow [r[rs1] + (r[rs2] \text{ or sign extnd(simm13))]$

Assembler

Syntax: `ld [address], cregrd`

Description: The LDC instruction moves a word from memory into a coprocessor register, c[rd]. The effective memory address is derived by summing the contents of r[rs1] and either the contents of r[rs2] if the instruction's *i* bit equals zero, or the 13-bit, sign-extended immediate operand contained in the instruction if *i* equals one.

If the PSR's EC bit is set to zero or if no coprocessor is present, a cp_disabled trap will be generated. If LDC takes a trap, the state of the coprocessor depends on the particular implementation.

If the instruction following a coprocessor load uses the load's c[rd] register as a source operand, hardware interlocks add one or more delay cycles to the following instruction depending upon the memory subsystem.

Programming note: If *rs1* is set to 0 and *i* is set to 1, any location in the lowest or highest 4 kbytes of an address space can be accessed without setting up a register.

Traps:
 cp_disabled
 cp_exception
 memory_address_not_aligned
 data_access_exception

Format:

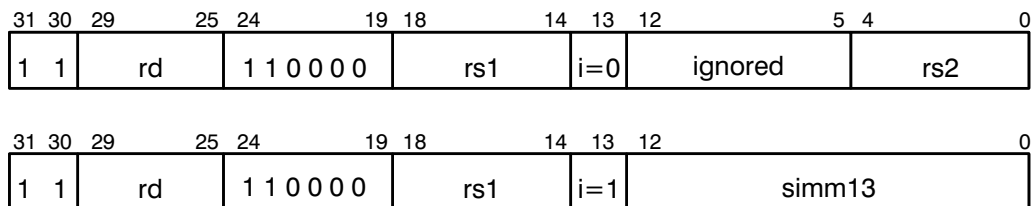

LDCSR

Load Coprocessor State Register

LDCSR

Operation: CSR ← [r[rs1] + (r[rs2] or sign extnd(simm13))]

Assembler

Syntax: ld [address], %csr

Description: The LDCSR instruction moves a word from memory into the Coprocessor State Register. The effective memory address is derived by summing the contents of r[rs1] and either the contents of r[rs2] if the instruction's *i* bit equals zero, or the 13-bit, sign-extended immediate operand contained in the instruction if *i* equals one.

If the PSR's EC bit is set to zero or if no coprocessor is present, a cp_disabled trap will be generated. If LDCSR takes a trap, the state of the coprocessor depends on the particular implementation.

If the instruction following a LDCSR uses the CSR as a source operand, hardware interlocks add one or more delay cycles to the following instruction depending upon implementation of the coprocessor.

Programming note: If *rs1* is set to 0 and *i* is set to 1, any location in the lowest or highest 4 kbytes of an address space can be accessed without setting up a register.

Traps:
cp_disabled
cp_exception
memory_address_not_aligned
data_access_exception

Format:

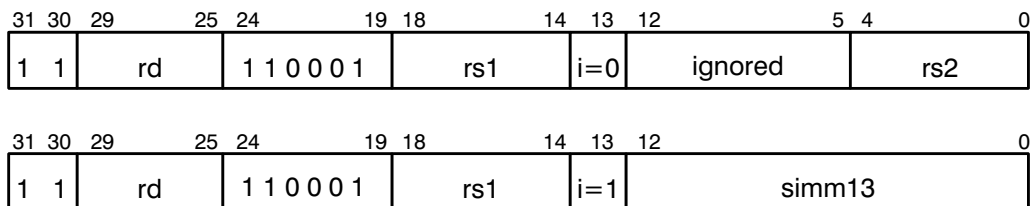

LDD

Load Doubleword

LDD

Operation: $r[rd] \leftarrow [r[rs1] + (r[rs2] \text{ or sign extnd}(\text{simm13}))]$
 $r[rd + 1] \leftarrow [(r[rs1] + (r[rs2] \text{ or sign extnd}(\text{simm13}))) + 4]$

Assembler Syntax: `ldd [address], regrd`

Description: The LDD instruction moves a doubleword from memory into a destination register pair, r[rd] and r[rd+1]. The effective memory address is derived by summing the contents of r[rs1] and either the contents of r[rs2] if the instruction's *i* bit equals zero, or the 13-bit, sign-extended immediate operand contained in the instruction if *i* equals one. The most significant memory word is always moved into the even-numbered destination register and the least significant memory word is always moved into the next odd-numbered register (see discussion in Section NO TAG).

If a data_access_exception trap takes place during the effective address memory access, the destination registers remain unchanged.

If the instruction following an integer load uses the load's r[rd] register as a source operand, hardware interlocks add one or more delay cycles to the following instruction depending upon the memory subsystem. For an LDD, this applies to both destination registers.

Programming note: If *rs1* is set to 0 and *i* is set to 1, any location in the lowest or highest 4 kbytes of an address space can be accessed without setting up a register.

Traps: `memory_address_not_aligned`
`data_access_exception`

Format:

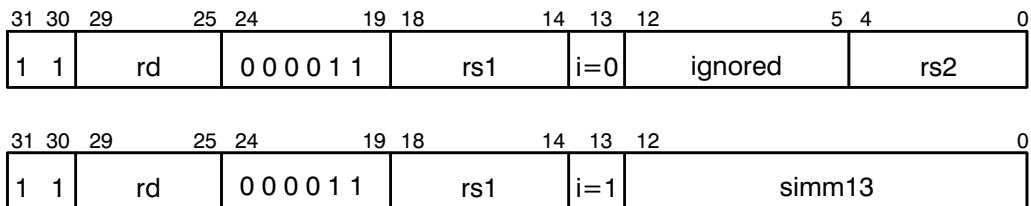

LDDA

Load Doubleword from Alternate space

LDDA

(Privileged Instruction)

Operation: address space ← asi
 $r[rd] \leftarrow [r[rs1] + r[rs2]]$
 $r[rd + 1] \leftarrow [r[rs1] + r[rs2] + 4]$

Assembler Syntax: `ldda [regaddr] asi, regrd`

Description: The LDDA instruction moves a doubleword from memory into the destination registers, r[rd] and r[rd+1]. The effective memory address is a combination of the address space value given in the *asi* field and the address derived by summing the contents of r[rs1] and r[rs2]. The most significant memory word is always moved into the even-numbered destination register and the least significant memory word is always moved into the next odd-numbered register (see discussion in Section NO TAG).

If a trap takes place during the effective address memory access, the destination registers remain unchanged.

If the instruction following an integer load uses the load's r[rd] register as a source operand, hardware interlocks add one or more delay cycles to the following instruction depending upon the memory subsystem. For an LDDA, this applies to both destination registers.

Traps: illegal_instruction (if i=1)
 privileged_instruction (if S=0)
 memory_address_not_aligned
 data_access_exception

Format:

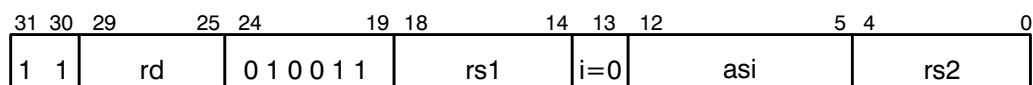

LDDC

Load Doubleword Coprocessor

LDDC

Operation: $c[rd] \leftarrow [r[rs1] + (r[rs2] \text{ or sign extnd(simm13))]$
 $c[rd + 1] \leftarrow [(r[rs1] + (r[rs2] \text{ or sign extnd(simm13)))] + 4]$

Assembler

Syntax: `ldd [address], cregrd`

Description:

The LDDC instruction moves a doubleword from memory into the coprocessor registers, c[rd] and c[rd+1]. The effective memory address is derived by summing the contents of r[rs1] and either the contents of r[rs2] if the instruction's *i* bit equals zero, or the 13-bit, sign-extended immediate operand contained in the instruction if *i* equals one. The most significant memory word is always moved into the even-numbered destination register and the least significant memory word is always moved into the next odd-numbered register (see discussion in Section NO TAG).

If the PSR's EC bit is set to zero or if no coprocessor is present, a cp_disabled trap will be generated. If LDDC takes a trap, the state of the coprocessor depends on the particular implementation.

If the instruction following a coprocessor load uses the load's c[rd] register as a source operand, hardware interlocks add one or more delay cycles to the following instruction depending upon the memory subsystem and coprocessor implementation. For an LDDC, this applies to both destination registers.

Programming note: If *rs1* is set to 0 and *i* is set to 1, any location in the lowest or highest 4 kbytes of an address space can be accessed without setting up a register.

Traps:

- cp_disabled
- cp_exception
- memory_address_not_aligned
- data_access_exception

Format:

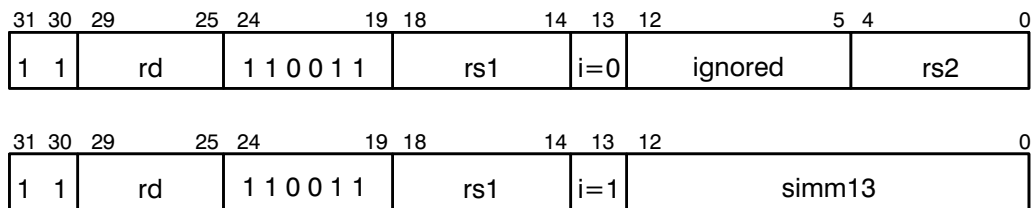

LDDF

Load Doubleword Floating-Point

LDDF

Operation: $f[rd] \leftarrow [r[rs1] + (r[rs2] \text{ or sign extnd(simm13))]$
 $f[rd + 1] \leftarrow [(r[rs1] + (r[rs2] \text{ or sign extnd(simm13)))] + 4]$

Assembler

Syntax: `ldd [address], fregrd`

Description:

The LDDF instruction moves a doubleword from memory into the floating-point registers, f[rd] and f[rd+1]. The effective memory address is derived by summing the contents of r[rs1] and either the contents of r[rs2] if the instruction's *i* bit equals zero, or the 13-bit, sign-extended immediate operand contained in the instruction if *i* equals one. The most significant memory word is always moved into the even-numbered destination register and the least significant memory word is always moved into the next odd-numbered register (see discussion in Section NO TAG).

If the PSR's EF bit is set to zero or if no floating-point unit is present, an fp_disabled trap will be generated. If a trap takes place during the effective address memory access, the destination registers remain unchanged.

If the instruction following a floating-point load uses the load's f[rd] register as a source operand, hardware interlocks add one or more delay cycles to the following instruction depending upon the memory subsystem. For an LDDF, this applies to both destination registers.

Programming note: If *rs1* is set to 0 and *i* is set to 1, any location in the lowest or highest 4 kbytes of an address space can be accessed without setting up a register.

Traps:

fp_disabled
 fp_exception*
 memory_address_not_aligned
 data_access_exception

Format:

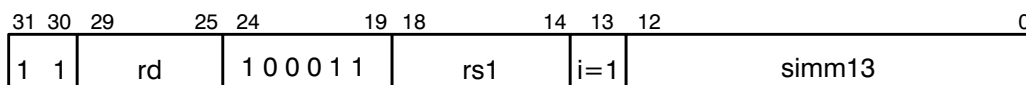
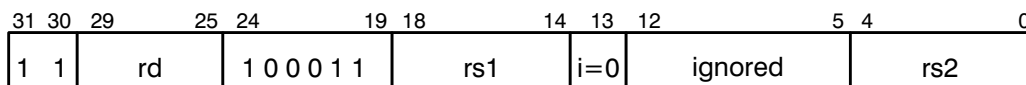

* NOTE: An attempt to execute any FP instruction will cause a pending FP exception to be recognized by the integer unit.

LDF

Load Floating-Point register

LDF

Operation: $f[rd] \leftarrow [r[rs1] + (r[rs2] \text{ or sign extnd}(\text{simmm13}))]$

Assembler

Syntax: `ld [address], freg rd`

Description: The LDF instruction moves a word from memory into a floating-point register, f[rd]. The effective memory address is derived by summing the contents of r[rs1] and either the contents of r[rs2] if the instruction's *i* bit equals zero, or the 13-bit, sign-extended immediate operand contained in the instruction if *i* equals one.

If the PSR's EF bit is set to zero or if no Floating-Point Unit is present, an fp_disabled trap will be generated. If LDF takes a trap, the contents of the destination register remain unchanged.

If the instruction following a floating-point load uses the load's f[rd] register as a source operand, hardware interlocks add one or more delay cycles to the following instruction depending upon the memory subsystem.

Programming note: If *rs1* is set to 0 and *i* is set to 1, any location in the lowest or highest 4 kbytes of an address space can be accessed without setting up a register.

Traps: fp_disabled
fp_exception*
memory_address_not_aligned
data_access_exception

Format:

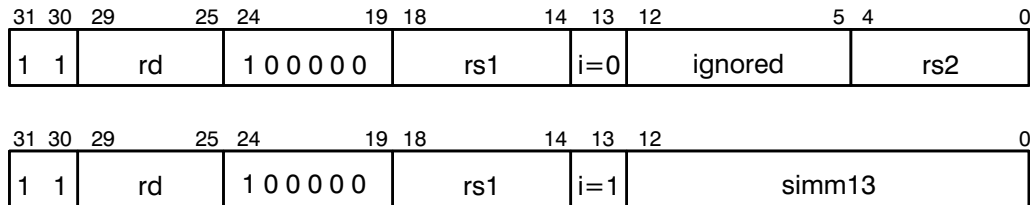

* NOTE: An attempt to execute any FP instruction will cause a pending FP exception to be recognized by the integer unit.

LDFSR

Load Floating-Point State Register

LDFSR

Operation: $FSR \leftarrow [r[rs1] + (r[rs2] \text{ or } \text{sign_extnd}(\text{simm13}))]$

Assembler

Syntax: `ld [address], %fsr`

Description: The LDFSR instruction moves a word from memory into the floating-point state register. The effective memory address is derived by summing the contents of r[rs1] and either the contents of r[rs2] if the instruction's *i* bit equals zero, or the 13-bit, sign-extended immediate operand contained in the instruction if *i* equals one. This instruction will wait for all pending FPOps to complete execution before it loads the memory word into the FSR.

If the PSR's EF bit is set to zero or if no floating-point unit is present, an fp_disabled trap will be generated. If LDFSR takes a trap, the contents of the FSR remain unchanged.

If the instruction following a LDFSR uses the FSR as a source operand, hardware interlocks add one or more cycle delay to the following instruction depending upon the memory subsystem.

Programming note: If *rs1* is set to 0 and *i* is set to 1, any location in the lowest or highest 4 kbytes of an address space can be accessed without setting up a register.

Traps:
fp_disabled
fp_exception*
memory_address_not_aligned
data_access_exception

Format:

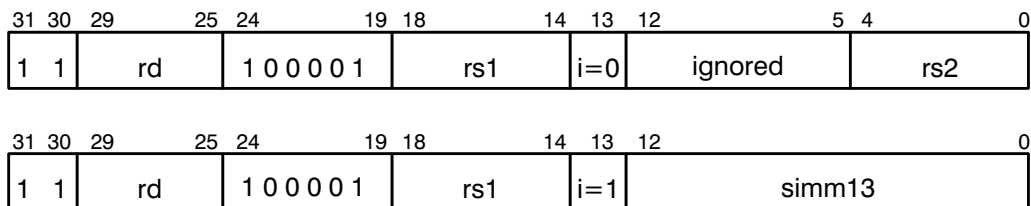

* NOTE: An attempt to execute any FP instruction will cause a pending FP exception to be recognized by the integer unit.

LDSB

Load Signed Byte

LDSB

Operation: $r[rd] \leftarrow \text{sign extnd}[r[rs1] + (r[rs2] \text{ or } \text{sign extnd}(\text{simm13}))]$

Assembler

Syntax: `ldsb [address], regrd`

Description: The LDSB instruction moves a signed byte from memory into the destination register, r[rd]. The effective memory address is derived by summing the contents of r[rs1] and either the contents of r[rs2] if the instruction's *i* bit equals zero, or the 13-bit, sign-extended immediate operand contained in the instruction if *i* equals one. The fetched byte is right-justified and sign-extended in r[rd].

If LDSB takes a trap, the contents of the destination register remain unchanged.

If the instruction following an integer load uses the load's r[rd] register as a source operand, hardware interlocks add one or more delay cycles to the following instruction depending upon the memory subsystem.

Programming note: If *rs1* is set to 0 and *i* is set to 1, any location in the lowest or highest 4 kbytes of an address space can be accessed without setting up a register.

Traps: data_access_exception

Format:

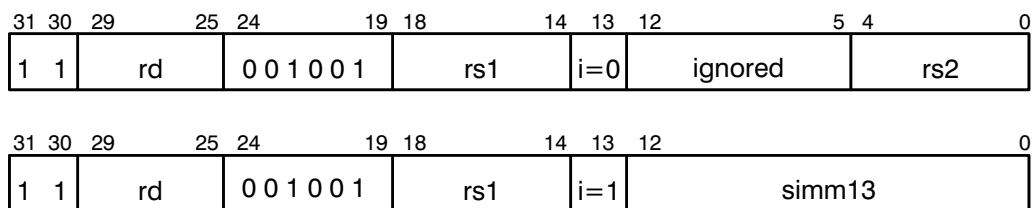

LDSBA

Load Signed Byte from Alternate space

LDSBA

(Privileged Instruction)

Operation: address space \leftarrow asi
 $r[rd] \leftarrow \text{sign extnd}[r[rs1] + r[rs2]]$

Assembler

Syntax: ldsba [*regaddr*] asi, *regrd*

Description: The LDSBA instruction moves a signed byte from memory into the destination register, r[rd]. The effective memory address is a combination of the address space value given in the *asi* field and the address derived by summing the contents of r[rs1] and r[rs2]. The fetched byte is right-justified and sign-extended in r[rd].

If LDSBA takes a trap, the contents of the destination register remain unchanged.

If the instruction following an integer load uses the load's r[rd] register as a source operand, hardware interlocks add one or more delay cycles depending upon the memory subsystem.

Traps: illegal_instruction (if i=1)
 privileged_instruction (if S=0)
 data_access_exception

Format:

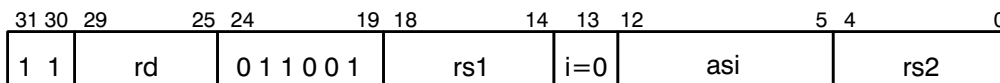

LDSH

Load Signed Halfword

LDSH

Operation: $r[rd] \leftarrow \text{sign extnd}[r[rs1] + (r[rs2] \text{ or } \text{sign extnd}(\text{simmm13}))]$

Assembler

Syntax: `ldsh [address], reg rd`

Description: The LDSH instruction moves a signed halfword from memory into the destination register, r[rd]. The effective memory address is derived by summing the contents of r[rs1] and either the contents of r[rs2] if the instruction's *i* bit equals zero, or the 13-bit, sign-extended immediate operand contained in the instruction if *i* equals one. The fetched halfword is right-justified and sign-extended in r[rd].

If LDSH takes a trap, the contents of the destination register remain unchanged.

If the instruction following an integer load uses the load's r[rd] register as a source operand, hardware interlocks add one or more delay cycles depending upon the memory subsystem.

Programming note: If *rs1* is set to 0 and *i* is set to 1, any location in the lowest or highest 4 kbytes of an address space can be accessed without setting up a register.

Traps: `memory_address_not_aligned`
`data_access_exception`

Format:



LDSHA

Load Signed Halfword from Alternate space

LDSHA

(Privileged Instruction)

Operation: address space ← asi
r[rd] ← sign extnd[r[rs1] + r[rs2]]

Assembler

Syntax: ldsha [*regaddr*] asi, *regrd*

Description: The LDSHA instruction moves a signed halfword from memory into the destination register, r[rd]. The effective memory address is a combination of the address space value given in the *asi* field and the address derived by summing the contents of r[rs1] and r[rs2]. The fetched halfword is right-justified and sign-extended in r[rd].

If LDSHA takes a trap, the contents of the destination register remain unchanged.

If the instruction following an integer load uses the load's r[rd] register as a source operand, hardware interlocks add one or more delay cycles depending upon the memory subsystem.

Traps: illegal_instruction (if i=1)
privileged_instruction (if S=0)
memory_address_not_aligned
data_access_exception

Format:

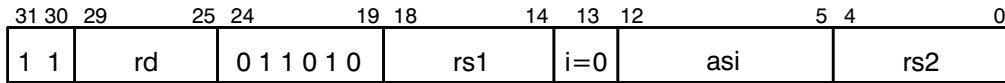

LDSTUB

Atomic Load/Store Unsigned Byte

LDSTUB

Operation: $r[rd] \leftarrow \text{zero extnd}[r[rs1] + (r[rs2] \text{ or sign extnd}(\text{simmm13}))]$
 $[r[rs1] + (r[rs2] \text{ or sign extnd}(\text{simmm13}))] \leftarrow \text{FFFFFFFF H}$

Assembler

Syntax: `ldstub [address], regrd`

Description:

The LDSTUB instruction moves an unsigned byte from memory into the destination register, r[rd], and rewrites the same byte in memory to all ones, while preventing asynchronous trap interruptions. In a multiprocessor system, two or more processors executing atomic load/store instructions which address the same byte simultaneously are guaranteed to execute them serially, in some order.

The effective memory address is derived by summing the contents of r[rs1] and either the contents of r[rs2] if the instruction's *i* bit equals zero, or the 13-bit, sign-extended immediate operand and contained in the instruction if *i* equals one. The fetched byte is right-justified and zero-extended in r[rd].

If the instruction following an integer load uses the load's r[rd] register as a source operand, hardware interlocks add one or more delay cycles depending upon the memory subsystem.

If LDSTUB takes a trap, the contents of the memory address remain unchanged.

Programming note: If *rs1* is set to 0 and *i* is set to 1, any location in the lowest or highest 4 kbytes of an address space can be accessed without setting up a register.

Traps: `data_access_exception`

Format:



LDSTUBA

Atomic Load/Store Unsigned Byte

LDSTUBA

in Alternate space

(Privileged Instruction)

Operation: address space ← asi
 $r[rd] \leftarrow \text{zero extnd}[r[rs1] + r[rs2]]$
 $[r[rs1] + r[rs2]] \leftarrow \text{FFFFFFFF H}$

Assembler

Syntax: `ldstuba [reg_addr] asi, reg_rd`

Description: The LDSTUBA instruction moves an unsigned byte from memory into the destination register, r[rd], and rewrites the same byte in memory to all ones, while preventing asynchronous trap interruptions. In a multiprocessor system, two or more processors executing atomic load/store instructions which address the same byte simultaneously are guaranteed to execute them in some serial order.

The effective memory address is a combination of the address space value given in the *asi* field and the address derived by summing the contents of r[rs1] and r[rs2]. The fetched byte is right-justified and zero-extended in r[rd].

If the instruction following an integer load uses the load's r[rd] register as a source operand, hardware interlocks add one or more delay cycles depending upon the memory subsystem.

If LDSTUBA takes a trap, the contents of the memory address remain unchanged.

Traps: illegal_instruction (if i=1)
 privileged_instruction (if S=0)
 data_access_exception

Format:

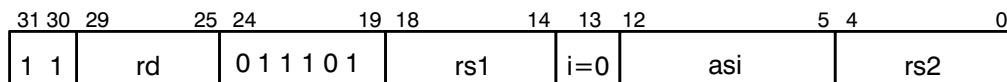

LDUB

Load Unsigned Byte

LDUB

Operation: $r[rd] \leftarrow \text{zero extnd}[r[rs1] + (r[rs2] \text{ or sign extnd}(\text{simm13}))]$

Assembler

Syntax: `ldub [address], regrd`

Description: The LDUB instruction moves an unsigned byte from memory into the destination register, r[rd]. The effective memory address is derived by summing the contents of r[rs1] and either the contents of r[rs2] if the instruction's *i* bit equals zero, or the 13-bit, sign-extended immediate operand contained in the instruction if *i* equals one. The fetched byte is right-justified and zero-extended in r[rd].

If LDUB takes a trap, the contents of the destination register remain unchanged.

If the instruction following an integer load uses the load's r[rd] register as a source operand, hardware interlocks add one or more delay cycles depending upon the memory subsystem.

Programming note: If *rs1* is set to 0 and *i* is set to 1, any location in the lowest or highest 4 kbytes of an address space can be accessed without setting up a register.

Traps: data_access_exception

Format:

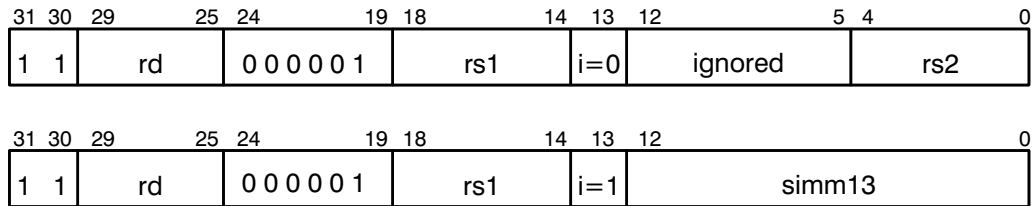

LDUBA

Load Unsigned Byte from Alternate space

LDUBA

(Privileged Instruction)

Operation: address space \leftarrow asi
 $r[rd] \leftarrow$ zero extnd[$r[rs1] + r[rs2]$]

Assembler

Syntax: lduba [*reg_addr*] asi, *reg_rd*

Description: The LDUBA instruction moves an unsigned byte from memory into the destination register, $r[rd]$. The effective memory address is a combination of the address space value given in the *asi* field and the address derived by summing the contents of $r[rs1]$ and $r[rs2]$. The fetched byte is right-justified and zero-extended in $r[rd]$.

If LDUBA takes a trap, the contents of the destination register remain unchanged.

If the instruction following an integer load uses the load's $r[rd]$ register as a source operand, hardware interlocks add one or more delay cycles depending upon the memory subsystem.

Traps: illegal_instruction (if $i=1$)
 privileged_instruction (if $S=0$)
 data_access_exception

Format:

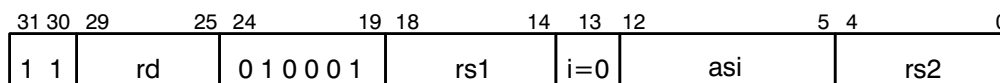

LDUH

Load Unsigned Halfword

LDUH

Operation: $r[rd] \leftarrow \text{zero extnd}[r[rs1] + (r[rs2] \text{ or sign extnd}(\text{simmm13}))]$

Assembler

Syntax: `lduh [address], regrd`

Description: The LDUH instruction moves an unsigned halfword from memory into the destination register, r[rd]. The effective memory address is derived by summing the contents of r[rs1] and either the contents of r[rs2] if the instruction's *i* bit equals zero, or the 13-bit, sign-extended immediate operand contained in the instruction if *i* equals one. The fetched halfword is right-justified and zero-extended in r[rd].

If LDUH takes a trap, the contents of the destination register remain unchanged.

If the instruction following an integer load uses the load's r[rd] register as a source operand, hardware interlocks add one or more delay cycles depending upon the memory subsystem.

Programming note: If *rs1* is set to 0 and *i* is set to 1, any location in the lowest or highest 4 kbytes of an address space can be accessed without setting up a register.

Traps: `memory_address_not_aligned`
`data_access_exception`

Format:

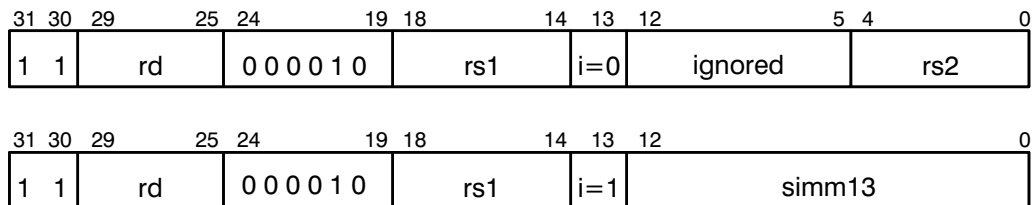

LDUHA **Load Unsigned Halfword from Alternate space** **LDUHA**
(Privileged Instruction)

Operation: address space ← asi
 r[rd] ← zero extnd[r[rs1] + r[rs2]]

Assembler

Syntax: lduha [*regaddr*] *asi*, *reg_{rd}*

Description: The LDUHA instruction moves an unsigned halfword from memory into the destination register, r[rd]. The effective memory address is a combination of the address space value given in the *asi* field and the address derived by summing the contents of r[rs1] and r[rs2]. The fetched halfword is right-justified and zero-extended in r[rd].

If LDUHA takes a trap, the contents of the destination register remain unchanged.

If the instruction following an integer load uses the load's r[rd] register as a source operand, hardware interlocks add one or more delay cycles depending upon the memory subsystem.

Traps: illegal_instruction (if i=1)
 privileged_instruction (if S=0)
 memory_address_not_aligned
 data_access_exception

Format:

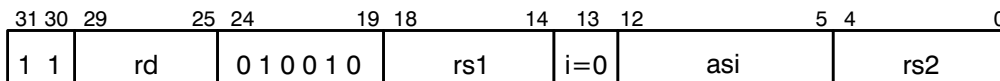

MULScc

Multiply Step and modify icc

MULScc

Operation: $op1 = (n \text{ XOR } v) \text{ CONCAT } r[rs1]<31:1>$
 if $(Y<0> = 0)$ $op2 = 0$, else $op2 = r[rs2]$ or $\text{sign extnd}(\text{sim}13)$
 $r[rd] \leftarrow op1 + op2$
 $Y \leftarrow r[rs1]<0> \text{ CONCAT } Y<31:1>$
 $n \leftarrow r[rd]<31>$
 $z \leftarrow \text{if } [r[rd]] = 0 \text{ then } 1, \text{ else } 0$
 $v \leftarrow ((op1<31> \text{ AND } op2<31> \text{ AND not } r[rd]<31>)$
 $\text{OR } (\text{not } op1<31> \text{ AND not } op2<31> \text{ AND } r[rd]<31>))$
 $c \leftarrow ((op1<31> \text{ AND } op2<31>)$
 $\text{OR } (\text{not } r[rd] \text{ AND } (op1<31> \text{ OR } op2<31>))$

Assembler

Syntax: `mulsccl reg_rs1, reg_or_imm, reg_rd`

Description: The multiply step instruction can be used to generate the 64-bit product of two signed or unsigned words. MULScc works as follows:

1. The “incoming partial product” in $r[rs1]$ is shifted right by one bit and the high-order bit is replaced by the sign of the previous partial product ($n \text{ XOR } v$). This is operand1.
2. If the least significant bit of the multiplier in the Y register equals zero, then operand2 is set to zero. If the LSB of the Y register equal one, then operand2 becomes the multiplicand, which is either the contents of $r[rs2]$ if the instruction i field is zero, or $\text{sign extnd}(\text{sim}13)$ if the i field is one. Operand2 is then added to operand1 and stored in $r[rd]$ (the outgoing partial product).
3. The multiplier in the Y register is then shifted right by one bit and its high-order bit is replaced by the least significant bit of the incoming partial product in $r[rs1]$.
4. The PSR’s integer condition codes are updated according to the addition performed in step 2.

Traps: none

Format:



OR

Inclusive-Or

OR

Operation: $r[rd] \leftarrow r[rs1] \text{ OR } (r[rs2] \text{ or sign extnd(simm13)})$

Assembler

Syntax: *or reg_{rs1}, reg_or_imm, reg_{rd}*

Description: This instruction does a bitwise logical OR of the contents of register r[rs1] with either the contents of r[rs2] (if bit field i=0) or the 13-bit, sign-extended immediate value contained in the instruction (if bit field i=1). The result is stored in register r[rd].

Traps: none

Format:

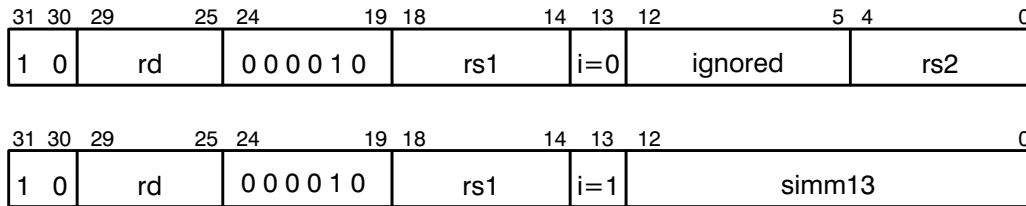

ORcc

Inclusive-Or and modify icc

ORcc

Operation: $r[rd] \leftarrow r[rs1] \text{ OR } (r[rs2] \text{ or sign extnd}(\text{simm13}))$
 $n \leftarrow r[rd] < 31 >$
 $z \leftarrow \text{if } [r[rd]] = 0 \text{ then } 1, \text{ else } 0$
 $v \leftarrow 0$
 $c \leftarrow 0$

Assembler

Syntax: `orcc regrs1, reg_or_imm, regrd`

Description: This instruction does a bitwise logical OR of the contents of register $r[rs1]$ with either the contents of $r[rs2]$ (if bit field $i=0$) or the 13-bit, sign-extended immediate value contained in the instruction (if bit field $i=1$). The result is stored in register $r[rd]$. ORcc also modifies all the integer condition codes in the manner described above.

Traps: none

Format:



ORN

Inclusive-Or Not

ORN

Operation: $r[rd] \leftarrow r[rs1] \text{ OR } \text{not}(\text{operand2})$, where $\text{operand2} = (r[rs2] \text{ or } \text{sign_extnd}(\text{simm13}))$

Assembler

Syntax: `orn reg_rs1, reg_or_imm, reg_rd`

Description: This instruction does a bitwise logical OR of the contents of register $r[rs1]$ with the one's complement of either the contents of $r[rs2]$ (if bit field $i=0$) or the 13-bit, sign-extended immediate value contained in the instruction (if bit field $i=1$). The result is stored in register $r[rd]$.

Traps: none

Format:

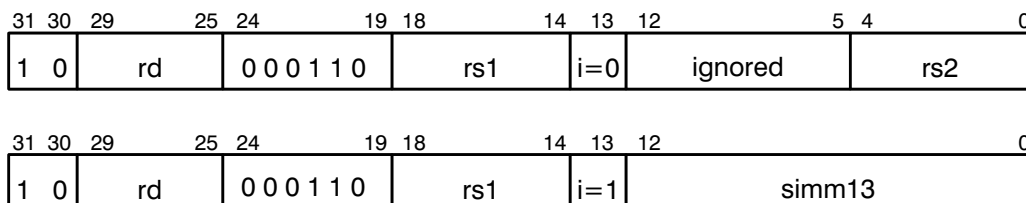

ORNcc

Inclusive-Or Not and modify icc

ORNcc

Operation: $r[rd] \leftarrow r[rs1] \text{ OR } \text{not}(\text{operand2})$, where $\text{operand2} = (r[rs2] \text{ or } \text{sign_extnd}(\text{simm13}))$
 $n \leftarrow r[rd] < 31 >$
 $z \leftarrow \text{if } [r[rd]] = 0 \text{ then } 1, \text{ else } 0$
 $v \leftarrow 0$
 $c \leftarrow 0$

Assembler

Syntax: `orncc reg_rs1, reg_or_imm, reg_rd`

Description: This instruction does a bitwise logical OR of the contents of register $r[rs1]$ with the one's complement of either the contents of $r[rs2]$ (if bit field $i=0$) or the 13-bit, sign-extended immediate value contained in the instruction (if bit field $i=1$). The result is stored in register $r[rd]$. ORNcc also modifies all the integer condition codes in the manner described above.

Traps: none

Format:



RDPSR

**Read Processor State Register
(Privileged Instruction)**

RDPSR

Operation: $r[rd] \leftarrow \text{PSR}$

Assembler

Syntax: $rd \text{ \%psr, } reg_{rd}$

Description: RDPSR copies the contents of the PSR into the register specified by the *rd* field.

Traps: privileged-instruction (if S=0)

Format:

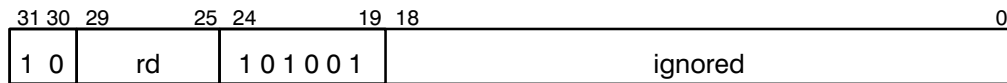

RDTBR

Read Trap Base Register
(Privileged Instruction)

RDTBR

Operation: $r[rd] \leftarrow \text{TBR}$

Assembler

Syntax: $rd \text{ \%tbr, } reg_{rd}$

Description: RDTBR copies the contents of the TBR into the register specified by the *rd* field.

Traps: *privileged_instruction* (if S=0)

Format:

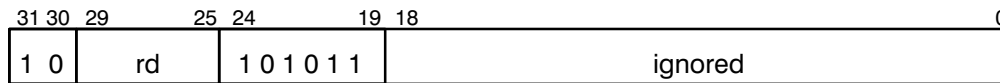

RDWIM

Read Window Invalid Mask register

RDWIM

(Privileged Instruction)

Operation: $r[rd] \leftarrow WIM$

Assembler

Syntax: `rd %wim, regrd`

Description: RDWIM copies the contents of the WIM register into the register specified by the *rd* field.

Traps: `privileged_instruction` (if S=0)

Format:

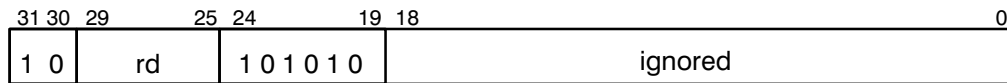

RDY

Read Y register

RDY

Operation: $r[rd] \leftarrow Y$

Assembler

Syntax: $rd \ \%y, reg_{rd}$

Description: RDY copies the contents of the Y register into the register specified by the *rd* field.

Traps: none

Format:

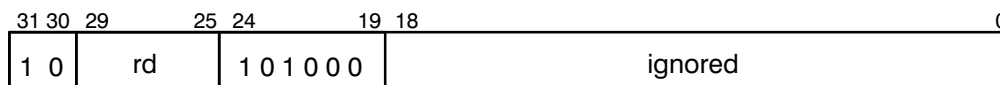

RESTORE

Restore caller's window

RESTORE

Operation: $ncwp \leftarrow CWP + 1$
 $result \leftarrow r[rs1] + (r[rs2] \text{ or sign extnd}(simm13))$
 $CWP \leftarrow ncwp$
 $r[rd] \leftarrow result$
 RESTORE does not affect condition codes

Assembler

Syntax: `restore reg_rs1, reg_or_imm, reg_rd`

Description: RESTORE adds one to the Current Window Pointer (modulo the number of implemented windows) and compares this value against the Window Invalid Mask register. If the new window number corresponds to an invalidated window ($WIM \text{ AND } 2^{ncwp} = 1$), a `window_underflow` trap is generated. If the new window number is not invalid (i.e., its corresponding WIM bit is reset), then the contents of `r[rs1]` is added to either the contents of `r[rs2]` (field bit $i = 1$) or to the 13-bit, sign-extended immediate value contained in the instruction (field bit $i = 0$). Because the CWP has not been updated yet, `r[rs1]` and `r[rs2]` are read from the currently addressed window (the called window).

The new CWP value is written into the PSR, causing the previous window (the caller's window) to become the active window. The result of the addition is now written into the `r[rd]` register of the restored window.

Note that arithmetic operations involving the CWP are always done modulo the number of implemented windows (8 for the CY7C601).

Traps: `window_underflow`

Format:

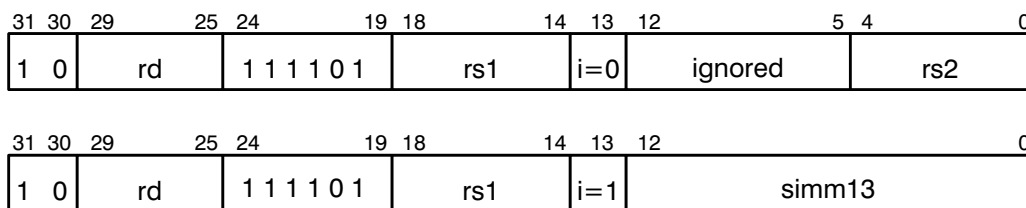

RETT**Return from Trap****RETT****(Privileged Instruction)**

Operation:

$$\begin{aligned} \text{ncwp} &\leftarrow \text{CWP} + 1 \\ \text{ET} &\leftarrow 1 \\ \text{PC} &\leftarrow \text{nPC} \\ \text{nPC} &\leftarrow \text{r}[\text{rs1}] + (\text{r}[\text{rs2}] \text{ or sign extnd}(\text{simmm13})) \\ \text{CWP} &\leftarrow \text{ncwp} \\ \text{S} &\leftarrow \text{pS} \end{aligned}$$
Assembler

Syntax: `rett address`

Description:

RETT adds one to the Current Window Pointer (modulo the number of implemented windows) and compares this value against the Window Invalid Mask register. If the new window number corresponds to an invalidated window ($\text{WIM AND } 2^{\text{ncwp}} = 1$), a `window_underflow` trap is generated. If the new window number is not invalid (i.e., its corresponding WIM bit is reset), then RETT causes a delayed control transfer to the address derived by adding the contents of `r[rs1]` to either the contents of `r[rs2]` (field bit $i = 1$) or to the 13-bit, sign-extended immediate value contained in the instruction (field bit $i = 0$).

Before the control transfer takes place, the new CWP value is written into the PSR, causing the previous window (the one in which the trap was taken) to become the active window. In addition, the PSR's ET bit is set to one (traps enabled) and the previous Supervisor bit (pS) is restored to the S field.

Although in theory RETT is a delayed control transfer instruction, in practice, RETT must always be immediately preceded by a JMPL instruction, creating a delayed control transfer couple (see Section NO TAG). This has the effect of annulling the delay instruction.

If traps were already enabled before encountering the RETT instruction, an `illegal_instruction` trap is generated. If traps are not enabled ($\text{ET} = 0$) when the RETT is encountered, but (1) the processor is not in supervisor mode ($\text{S} = 0$), or (2) the window underflow condition described above occurs, or (3) if either of the two low-order bits of the target address are nonzero, then a reset trap occurs. If a reset trap does occur, the *tt* field of the TBR encodes the trap condition: `privileged_instruction`, `window_underflow`, or `memory_address_not_aligned`.

Programming note: To re-execute the trapping instruction when returning from a trap handler, use the following sequence:

```

    jmpl    %17, %0           ! old PC
    rett   %18                ! old nPC
  
```

Note that the CY7C601 saves the PC in `r[17]` (local1) and the nPC in `r[18]` (local2) of the trap window upon entering a trap.

To return to the instruction after the trapping instruction (e.g., when the trapping instruction is emulated), use the sequence:

```

    jmpl    %18, %0           ! old nPC
    rett   %18 + 4           ! old nPC + 4
  
```

RETT

**Return from Trap
(Privileged Instruction)**

RETT

Traps: illegal_instruction
 reset (privileged_instruction)
 reset (memory_address_not_aligned)
 reset (window_underflow)

Format:

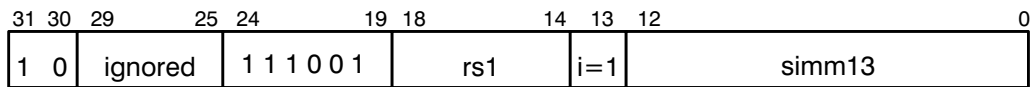
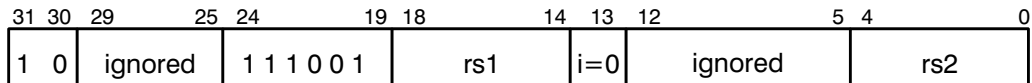

SAVE

Save caller's window

SAVE

Operation: $ncwp \leftarrow CWP - 1$
 $result \leftarrow r[rs1] + (r[rs2] \text{ or } sign\ extnd(sim13))$
 $CWP \leftarrow ncwp$
 $r[rd] \leftarrow result$
 SAVE does not affect condition codes

Assembler

Syntax: `save regrs1, reg_or_imm, regrd`

Description: SAVE subtracts one from the Current Window Pointer (modulo the number of implemented windows) and compares this value against the Window Invalid Mask register. If the new window number corresponds to an invalidated window ($WIM \text{ AND } 2^{ncwp} = 1$), a `window_overflow` trap is generated. If the new window number is not invalid (i.e., its corresponding WIM bit is reset), then the contents of $r[rs1]$ is added to either the contents of $r[rs2]$ (field bit $i = 1$) or to the 13-bit, sign-extended immediate value contained in the instruction (field bit $i = 0$). Because the CWP has not been updated yet, $r[rs1]$ and $r[rs2]$ are read from the currently addressed window (the calling window).

The new CWP value is written into the PSR, causing the active window to become the previous window, and the called window to become the active window. The result of the addition is now written into the $r[rd]$ register of the new window.

Note that arithmetic operations involving the CWP are always done modulo the number of implemented windows (8 for the CY7C601).

Traps: `window_overflow`

Format:

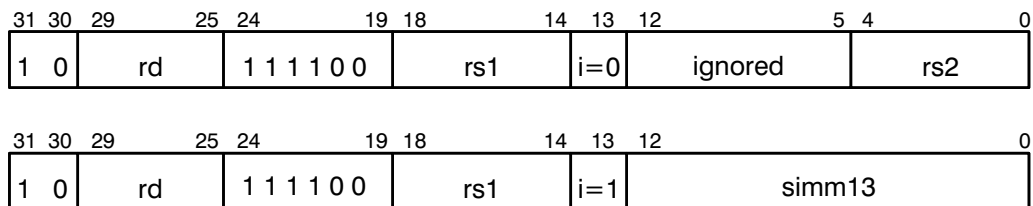

SETHI

Set High 22 bits of *r* register

SETHI

Operation: $r[rd]<31:10> \leftarrow imm22$
 $r[rd]<9:0> \leftarrow 0$

Assembler

Syntax: `sethi const22, regrd`
`sethi %hi value, regrd`

Description: SETHI zeros the ten least significant bits of the contents of *r*[*rd*] and replaces its high-order 22 bits with *imm22*. The condition codes are not affected.

Programming note: SETHI 0, %0 is the preferred instruction to use as a NOP, because it will not increase execution time if it follows a load instruction.

Traps: none

Format:

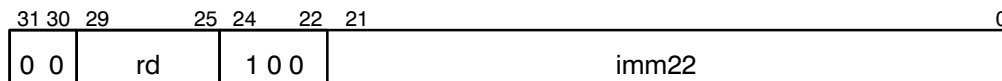

SLL

Shift Left Logical

SLL

Operation: $r[rd] \leftarrow r[rs1]$ SLL by $(r[rs2]$ or $shcnt$)

Assembler

Syntax: `sll reg_rs1, reg_or_imm, reg_rd`

Description: SLL shifts the contents of $r[rs1]$ left by the number of bits specified by the shift count, filling the vacated positions with zeros. The shifted results are written into $r[rd]$. No shift occurs if the shift count is zero.

If the i bit field equals zero, the shift count for SLL is the least significant five bits of the contents of $r[rs2]$. If the i bit field equals one, the shift count for SLL is the 13-bit, sign extended immediate value, $simm13$. In the instruction format and the operation description above, the least significant five bits of $simm13$ is called *shcnt*.

This instruction does *not* modify the condition codes.

Traps: none

Format:

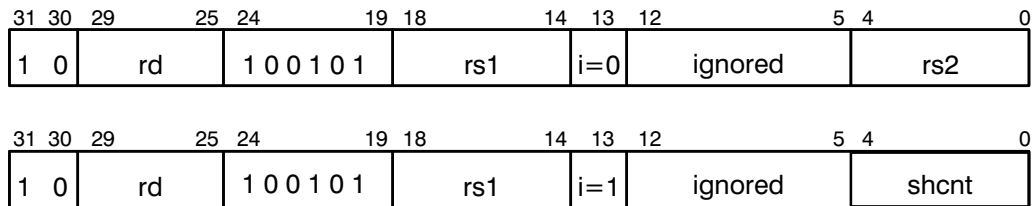

SRA

Shift Right Arithmetic

SRA

Operation: $r[rd] \leftarrow r[rs1]$ SRA by ($r[rs2]$ or *shcnt*)

Assembler

Syntax: `sra reg_rs1, reg_or_imm, reg_rd`

Description: SRA shifts the contents of $r[rs1]$ right by the number of bits specified by the shift count, filling the vacated positions with the MSB of $r[rs1]$. The shifted results are written into $r[rd]$. No shift occurs if the shift count is zero.

If the *i* bit field equals zero, the shift count for SRA is the least significant five bits of the contents of $r[rs2]$. If the *i* bit field equals one, the shift count for SRA is the 13-bit, sign extended immediate value, *simm13*. In the instruction format and the operation description above, the least significant five bits of *simm13* is called *shcnt*.

This instruction does *not* modify the condition codes.

Programming note: A “Shift Left Arithmetic by 1 (and calculate overflow)” can be implemented with an ADDcc instruction.

Traps: none

Format:

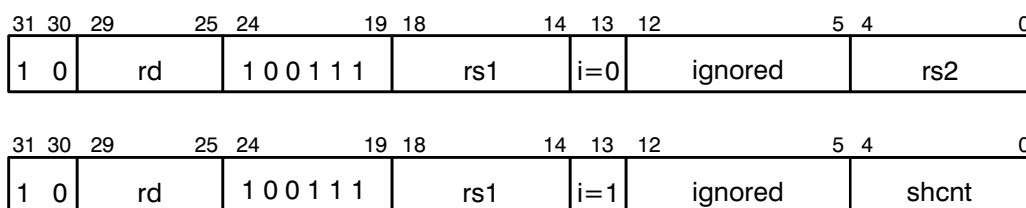

SRL

Shift Right Logical

SRL

Operation: $r[rd] \leftarrow r[rs1]$ SRL by $(r[rs2]$ or $shcnt$)

Assembler

Syntax: `srl reg_rs1, reg_or_imm, reg_rd`

Description: SRL shifts the contents of $r[rs1]$ right by the number of bits specified by the shift count, filling the vacated positions with zeros. The shifted results are written into $r[rd]$. No shift occurs if the shift count is zero.

If the i bit field equals zero, the shift count for SRL is the least significant five bits of the contents of $r[rs2]$. If the i bit field equals one, the shift count for SRL is the 13-bit, sign extended immediate value, $simm13$. In the instruction format and the operation description above, the least significant five bits of $simm13$ is called *shcnt*.

This instruction does *not* modify the condition codes.

Traps: none

Format:

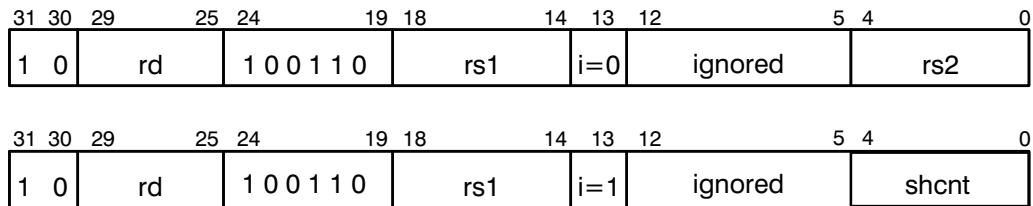

ST

Store Word

ST

Operation: $[r[rs1] + (r[rs2] \text{ or } \text{sign_extnd}(\text{simm13}))] \leftarrow r[rd]$

Assembler

Syntax: `st regrd, [address]`

Description: The ST instruction moves a word from the destination register, r[rd], into memory. The effective memory address is derived by summing the contents of r[rs1] and either the contents of r[rs2] if the instruction's *i* bit equals zero, or the 13-bit, sign-extended immediate operand contained in the instruction if *i* equals one.

If ST takes a trap, the contents of the memory address remain unchanged.

Programming note: If *rs1* is set to 0 and *i* is set to 1, any location in the lowest or highest 4 kbytes of an address space can be written to without setting up a register.

Traps: `memory_address_not_aligned`
`data_access_exception`

Format:

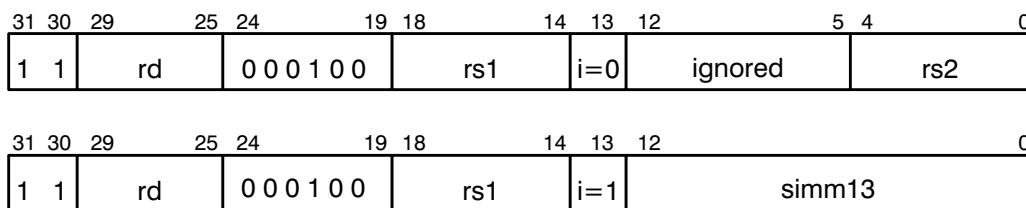

STA

Store Word into Alternate space
(Privileged Instruction)

STA

Operation: address space ← asi
[r[rs1] + r[rs2]] ← r[rd]

Assembler

Syntax: sta *reg_{rd}*, [*reg_{addr}*] *asi*

Description:

The STA instruction moves a word from the destination register, r[rd], into memory. The effective memory address is a combination of the address space value given in the *asi* field and the address derived by summing the contents of r[rs1] and r[rs2].

If STA takes a trap, the contents of the memory address remain unchanged.

Traps:

illegal_instruction (if i=1)
privileged_instruction (if S=0)
memory_address_not_aligned
data_access_exception

Format:

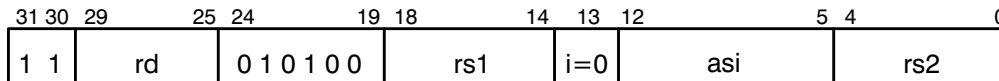

STB

Store Byte

STB

Operation: $[r[rs1] + (r[rs2] \text{ or } \text{sign_extnd}(\text{simm13}))] \leftarrow r[rd]$

Assembler

Syntax: `stb regrd, [address]`
synonyms: stub, stsb

Description: The STB instruction moves the least significant byte from the destination register, r[rd], into memory. The effective memory address is derived by summing the contents of r[rs1] and either the contents of r[rs2] if the instruction's *i* bit equals zero, or the 13-bit, sign-extended immediate operand contained in the instruction if *i* equals one.

If STB takes a trap, the contents of the memory address remain unchanged.

Programming note: If *rs1* is set to 0 and *i* is set to 1, any location in the lowest or highest 4 kbytes of an address space can be written to without setting up a register.

Traps: data_access_exception

Format:

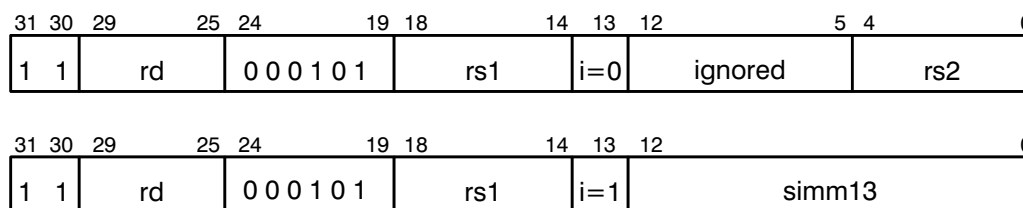

STBA

Store Byte into Alternate space

STBA

(Privileged Instruction)

Operation: address space ← asi
 [r[rs1] + r[rs2]] ← r[rd]

Assembler

Syntax: stba *reg_{rd}*, [*reg_{addr}*] *asi*
 synonyms: stuba, stsba

Description:

The STBA instruction moves the least significant byte from the destination register, r[rd], into memory. The effective memory address is a combination of the address space value given in the *asi* field and the address derived by summing the contents of r[rs1] and r[rs2].

If STBA takes a trap, the contents of the memory address remain unchanged.

Traps:

illegal_instruction (if i=1)
 privileged_instruction (if S=0)
 data_access_exception

Format:

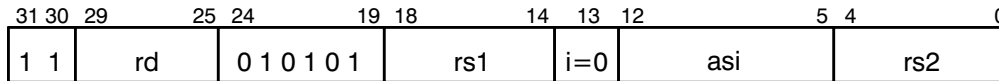

STC

Store Coprocessor register

STC

Operation: $[r[rs1] + (r[rs2] \text{ or } \text{sign_extnd}(\text{simm13}))] \leftarrow c[rd]$

Assembler

Syntax: `st cregrd, [address]`

Description: The STC instruction moves a word from a coprocessor register, $c[rd]$, into memory. The effective memory address is derived by summing the contents of $r[rs1]$ and either the contents of $r[rs2]$ if the instruction's i bit equals zero, or the 13-bit, sign-extended immediate operand contained in the instruction if i equals one.

If the PSR's EC bit is set to zero or if no coprocessor is present, a `cp_disabled` trap will be generated. If STC takes a trap, memory remains unchanged.

Programming note: If $rs1$ is set to 0 and i is set to 1, any location in the lowest or highest 4 kbytes of an address space can be written to without setting up a register.

Traps:

- `cp_disabled`
- `cp_exception`
- `memory_address_not_aligned`
- `data_access_exception`

Format:

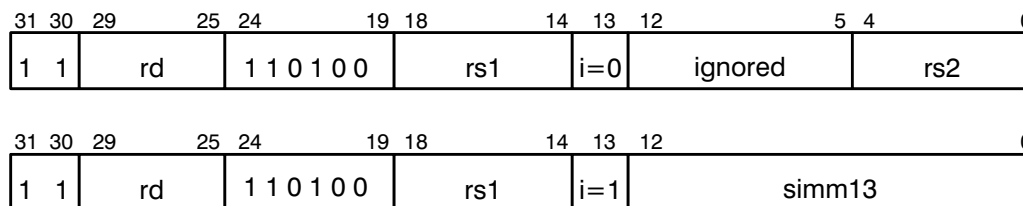

STCSR

Store Coprocessor State Register

STCSR

Operation: $[r[rs1] + (r[rs2] \text{ or } \text{sign_extnd}(\text{simmm13}))] \leftarrow \text{CSR}$

Assembler

Syntax: `st %csr, [address]`

Description: The STCSR instruction moves the contents of the Coprocessor State Register into memory. The effective memory address is derived by summing the contents of $r[rs1]$ and either the contents of $r[rs2]$ if the instruction's i bit equals zero, or the 13-bit, sign-extended immediate operand contained in the instruction if i equals one.

If the PSR's EC bit is set to zero or if no coprocessor is present, a `cp_disabled` trap will be generated. If STCSR takes a trap, the contents of the memory address remain unchanged.

Programming note: If $rs1$ is set to 0 and i is set to 1, any location in the lowest or highest 4 kbytes of an address space can be written to without setting up a register.

Traps:

- cp_disabled
- cp_exception
- memory_address_not_aligned
- data_access_exception

Format:



STD

Store Doubleword

STD

Operation: $[r[rs1] + (r[rs2] \text{ or } \text{sign_extnd}(\text{simm13}))] \leftarrow r[rd]$
 $[r[rs1] + (r[rs2] \text{ or } \text{sign_extnd}(\text{simm13})) + 4] \leftarrow r[rd + 1]$

Assembler

Syntax: `std regrd, [address]`

Description:

The STD instruction moves a doubleword from the destination register pair, r[rd] and r[rd+1], into memory. The effective memory address is derived by summing the contents of r[rs1] and either the contents of r[rs2] if the instruction's *i* bit equals zero, or the 13-bit, sign-extended immediate operand contained in the instruction if *i* equals one. The most significant word in the even-numbered destination register is written into memory at the effective address and the least significant memory word in the next odd-numbered register is written into memory at the effective address + 4.

If a `data_access_exception` trap takes place during the effective address memory access, memory remains unchanged.

Programming note: If *rs1* is set to 0 and *i* is set to 1, any location in the lowest or highest 4 kbytes of an address space can be written to without setting up a register.

Traps:

`memory_address_not_aligned`
`data_access_exception`

Format:

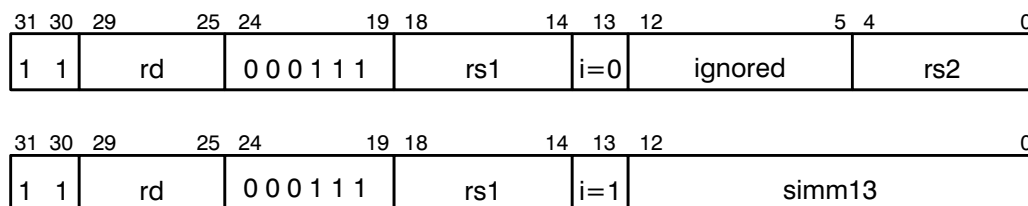

STDA

Store Doubleword into Alternate space

STDA

(Privileged Instruction)

Operation: address space ← asi
 $[r[rs1] + (r[rs2] \text{ or } \text{sign extnd}(\text{simm13}))] \leftarrow r[rd]$
 $[r[rs1] + (r[rs2] \text{ or } \text{sign extnd}(\text{simm13})) + 4] \leftarrow r[rd + 1]$

Assembler

Syntax: `stda regrd, [regaddr] asi`

Description:

The STDA instruction moves a doubleword from the destination register pair, r[rd] and r[rd+1], into memory. The effective memory address is a combination of the address space value given in the *asi* field and the address derived by summing the contents of r[rs1] and r[rs2]. The most significant word in the even-numbered destination register is written into memory at the effective address and the least significant memory word in the next odd-numbered register is written into memory at the effective address + 4.

If a `data_access_exception` trap takes place during the effective address memory access, memory remains unchanged.

Traps:

`illegal_instruction` (if *i*=1)
`privileged_instruction` (if *S*=0)
`memory_address_not_aligned`
`data_access_exception`

Format:

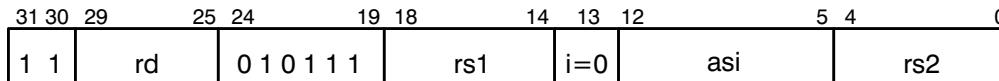

STDC

Store Doubleword Coprocessor

STDC

Operation: $[r[rs1] + (r[rs2] \text{ or } \text{sign_extnd}(\text{simm13}))] \leftarrow c[rd]$
 $[r[rs1] + (r[rs2] \text{ or } \text{sign_extnd}(\text{simm13})) + 4] \leftarrow c[rd + 1]$

Assembler

Syntax: `std cregrd, [address]`

Description: The STDC instruction moves a doubleword from the coprocessor register pair, c[rd] and c[rd+1], into memory. The effective memory address is derived by summing the contents of r[rs1] and either the contents of r[rs2] if the instruction's *i* bit equals zero, or the 13-bit, sign-extended immediate operand contained in the instruction if *i* equals one. The most significant word in the even-numbered destination register is written into memory at the effective address and the least significant memory word in the next odd-numbered register is written into memory at the effective address + 4.

If the PSR's EC bit is set to zero or if no coprocessor is present, a cp_disabled trap will be generated. If a data_access_exception trap takes place during the effective address memory access, memory remains unchanged.

Programming note: If *rs1* is set to 0 and *i* is set to 1, any location in the lowest or highest 4 kbytes of an address space can be written to without setting up a register.

Traps: cp_disabled
cp_exception
memory_address_not_aligned
data_access_exception

Format:

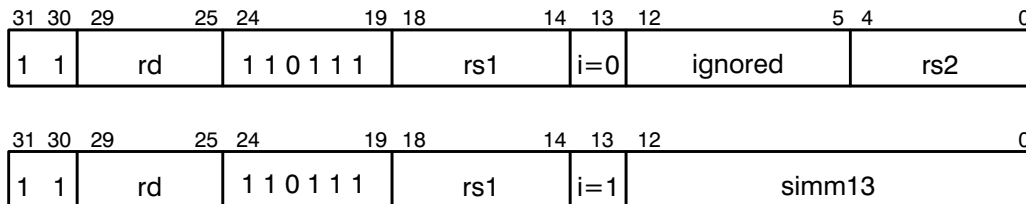

STDCQ

Store Doubleword Coprocessor Queue

STDCQ

(Privileged Instruction)

Operation: $[r[rs1] + (r[rs2] \text{ or sign extnd(simm13))}] \leftarrow \text{CQ.ADDR}$
 $[r[rs1] + (r[rs2] \text{ or sign extnd(simm13))} + 4] \leftarrow \text{CQ.INSTR}$

Assembler

Syntax: `std %cq, [address]`

Description:

The STDCQ instruction moves the front entry of the Coprocessor Queue into memory. The effective memory address is derived by summing the contents of r[rs1] and either the contents of r[rs2] if the instruction's *i* bit equals zero, or the 13-bit, sign-extended immediate operand contained in the instruction if *i* equals one. The address portion of the queue entry is written into memory at the effective address and the instruction portion of the entry is written into memory at the effective address + 4. If the PSR's EC bit is set to zero or if no coprocessor is present, a cp_disabled trap will be generated. If a data_access_exception trap takes place during the effective address memory access, memory remains unchanged.

Programming note: If *rs1* is set to 0 and *i* is set to 1, any location in the lowest or highest 4 kbytes of an address space can be written to without setting up a register.

Traps:

- cp_disabled
- cp_exception
- privileged_instruction (if S=0)
- memory_address_not_aligned
- data_access_exception

Format:

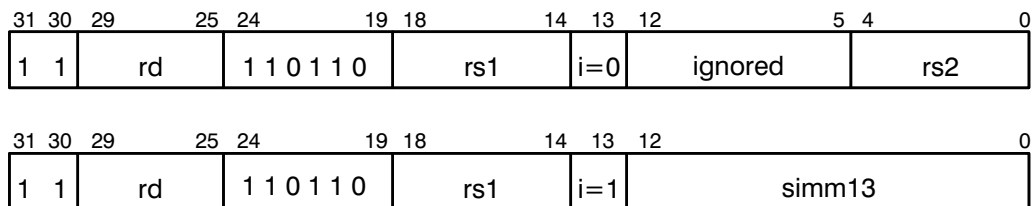

STDF

Store Doubleword Floating-Point

STDF

Operation: $[r[rs1] + (r[rs2] \text{ or } \text{sign extnd}(\text{simm13}))] \leftarrow f[rd]$
 $[r[rs1] + (r[rs2] \text{ or } \text{sign extnd}(\text{simm13})) + 4] \leftarrow f[rd + 1]$

Assembler

Syntax: `std fregrd, [address]`

Description:

The STDF instruction moves a doubleword from the floating-point register pair, f[rd] and f[rd+1], into memory. The effective memory address is derived by summing the contents of r[rs1] and either the contents of r[rs2] if the instruction's *i* bit equals zero, or the 13-bit, sign-extended immediate operand contained in the instruction if *i* equals one. The most significant word in the even-numbered destination register is written into memory at the effective address and the least significant memory word in the next odd-numbered register is written into memory at the effective address + 4.

If the PSR's EF bit is set to zero or if no floating-point unit is present, an fp_disabled trap will be generated. If a trap takes place, memory remains unchanged.

Programming note: If *rs1* is set to 0 and *i* is set to 1, any location in the lowest or highest 4 kbytes of an address space can be written to without setting up a register.

Traps:

- fp_disabled
- fp_exception*
- memory_address_not_aligned
- data_access_exception

Format:

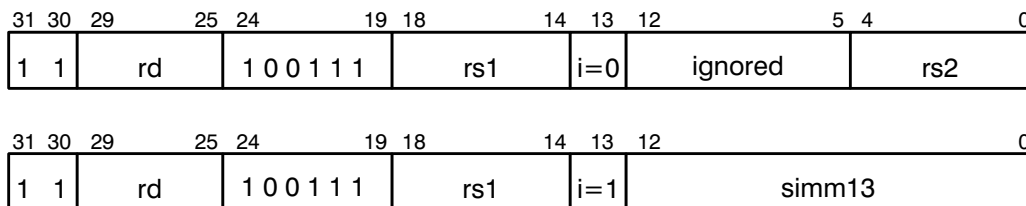

* NOTE: An attempt to execute any FP instruction will cause a pending FP exception to be recognized by the integer unit.

STDFQ

Store Doubleword Floating-Point Queue

STDFQ

(Privileged Instruction)

Operation: $[r[rs1] + (r[rs2] \text{ or sign extnd(simm13))}] \leftarrow \text{FQ.ADDR}$
 $[r[rs1] + (r[rs2] \text{ or sign extnd(simm13))} + 4] \leftarrow \text{FQ.INSTR}$

Assembler

Syntax: `std %fq, [address]`

Description:

The STDFQ instruction moves the front entry of the floating-point queue into memory. The effective memory address is derived by summing the contents of r[rs1] and either the contents of r[rs2] if the instruction's *i* bit equals zero, or the 13-bit, sign-extended immediate operand contained in the instruction if *i* equals one. The address portion of the queue entry is written into memory at the effective address and the instruction portion of the entry is written into memory at the effective address + 4. If the FPU is in exception mode, the queue is then advanced to the next entry, or it becomes empty (as indicated by the *qne* bit in the FSR).

If the PSR's EF bit is set to zero or if no floating-point unit is present, an fp_disabled trap will be generated. If a trap takes place, memory remains unchanged.

Programming note: If *rs1* is set to 0 and *i* is set to 1, any location in the lowest or highest 4 kbytes of an address space can be written to without setting up a register.

Traps:

- fp_disabled
- fp_exception*
- privileged_instruction (if S=0)
- memory_address_not_aligned
- data_access_exception

Format:

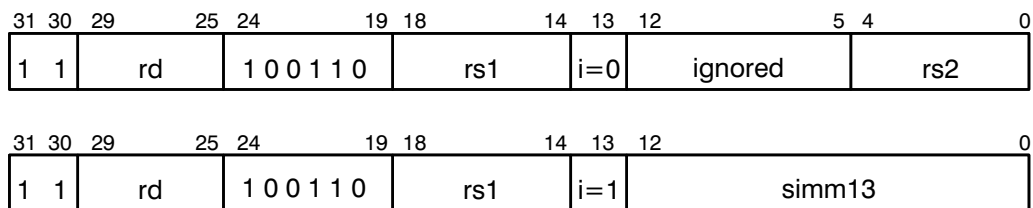

* NOTE: An attempt to execute any FP instruction will cause a pending FP exception to be recognized by the integer unit.

STF

Store Floating-Point register

STF

Operation: $[r[rs1] + (r[rs2] \text{ or } \text{sign_extnd}(\text{simm13}))] \leftarrow f[rd]$

Assembler

Syntax: `st fregrd, [address]`

Description: The STF instruction moves a word from a floating-point register, f[rd], into memory. The effective memory address is derived by summing the contents of r[rs1] and either the contents of r[rs2] if the instruction's *i* bit equals zero, or the 13-bit, sign-extended immediate operand contained in the instruction if *i* equals one.

If the PSR's EF bit is set to zero or if no floating-point unit is present, an fp_disabled trap will be generated. If STF takes a trap, memory remains unchanged.

Programming note: If *rs1* is set to 0 and *i* is set to 1, any location in the lowest or highest 4 kbytes of an address space can be written to without setting up a register.

Traps:

- fp_disabled
- fp_exception*
- memory_address_not_aligned
- data_access_exception

Format:

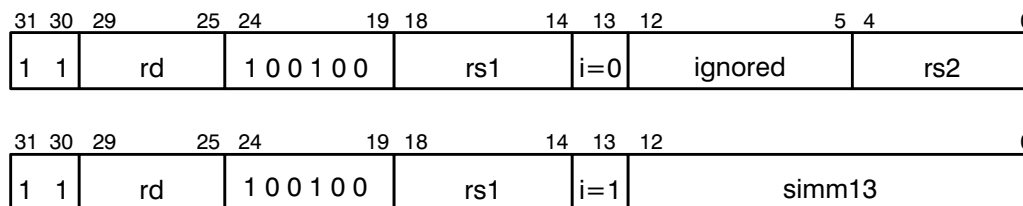

* NOTE: An attempt to execute any FP instruction will cause a pending FP exception to be recognized by the integer unit.

STFSR

Store Floating-Point State Register

STFSR

Operation: $[r[rs1] + (r[rs2] \text{ or } \text{sign_extnd}(\text{simmm13}))] \leftarrow \text{FSR}$

Assembler

Syntax: `st %fsr, [address]`

Description: The STFSR instruction moves the contents of the Floating-Point State Register into memory. The effective memory address is derived by summing the contents of r[rs1] and either the contents of r[rs2] if the instruction's *i* bit equals zero, or the 13-bit, sign-extended immediate operand contained in the instruction if *i* equals one. This instruction will wait for all pending FPOps to complete execution before it writes the FSR into memory.

If the PSR's EF bit is set to zero or if no floating-point unit is present, an fp_disabled trap will be generated. If STFSR takes a trap, the contents of the memory address remain unchanged.

Programming note: If *rs1* is set to 0 and *i* is set to 1, any location in the lowest or highest 4 kbytes of an address space can be written to without setting up a register.

Traps:
 fp_disabled
 fp_exception*
 memory_address_not_aligned
 data_access_exception

Format:

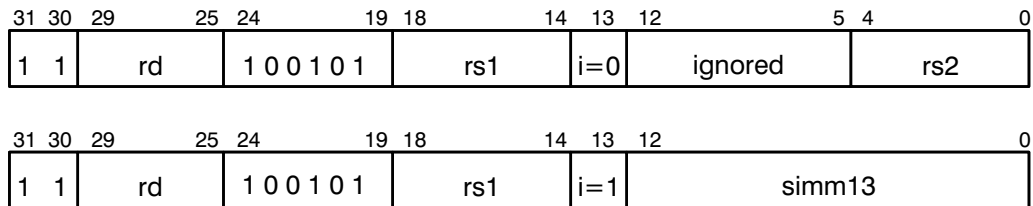

* NOTE: An attempt to execute any FP instruction will cause a pending FP exception to be recognized by the integer unit.

STH

Store Halfword

STH

Operation: $[r[rs1] + (r[rs2] \text{ or } \text{sign_extnd}(\text{simm13}))] \leftarrow r[rd]$

Assembler

Syntax: `sth regrd, [address]` synonyms: `stuh`, `stsh`

Description: The STH instruction moves the least significant halfword from the destination register, `r[rd]`, into memory. The effective memory address is derived by summing the contents of `r[rs1]` and either the contents of `r[rs2]` if the instruction's *i* bit equals zero, or the 13-bit, sign-extended immediate operand contained in the instruction if *i* equals one.

If STH takes a trap, the contents of the memory address remain unchanged.

Programming note: If *rs1* is set to 0 and *i* is set to 1, any location in the lowest or highest 4 kbytes of an address space can be written to without setting up a register.

Traps: `memory_address_not_aligned`
`data_access_exception`

Format:

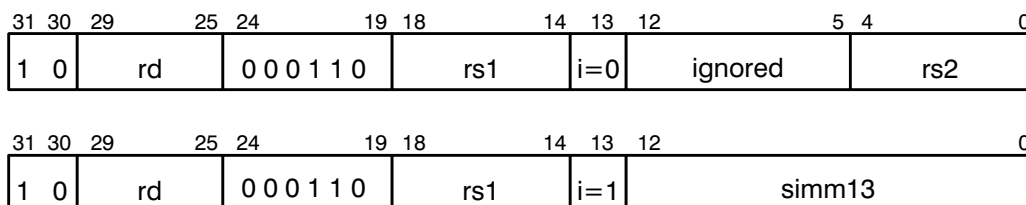

STHA

Store Halfword into Alternate space

STHA

(Privileged Instruction)

Operation: address space ← asi
 [r[rs1] + (r[rs2] or sign extnd(simm13))] ← r[rd]

Assembler

Syntax: stha *reg_{rd}*, [*address*]
 synonyms: stuha, stsha

Description:

The STHA instruction moves the least significant halfword from the destination register, r[rd], into memory. The effective memory address is a combination of the address space value given in the *asi* field and the address derived by summing the contents of r[rs1] and r[rs2].

If STHA takes a trap, the contents of the memory address remain unchanged.

Traps:

illegal_instruction (if i=1)
 privileged_instruction (if S=0)
 memory_address_not_aligned
 data_access_exception

Format:

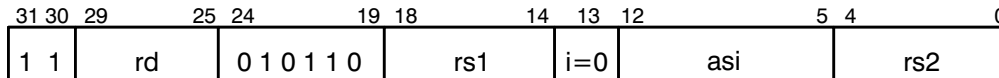

SUB

Subtract

SUB

Operation: $r[rd] \leftarrow r[rs1] - (r[rs2] \text{ or sign extnd}(\text{simm13}))$

Assembler

Syntax: `sub reg_rs1, reg_or_imm, reg_rd`

Description: The SUB instruction subtracts either the contents of the register named in the *rs2* field, $r[rs2]$, if the instruction's *i* bit equals zero, or the 13-bit, sign-extended immediate operand contained in the instruction if *i* equals one, from register $r[rs1]$. The result is placed in the register specified in the *rd* field.

Traps: none

Format:

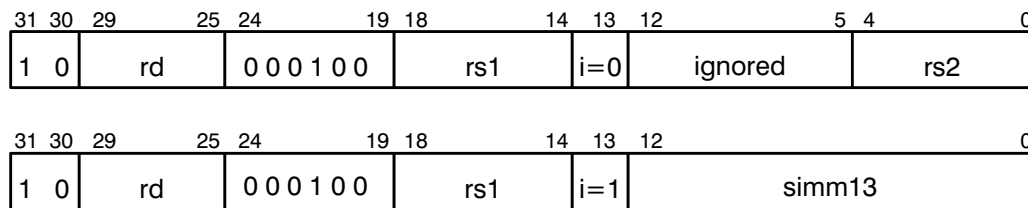

SUBcc

Subtract and modify icc

SUBcc

Operation: $r[rd] \leftarrow r[rs1] - \text{operand2}$, where $\text{operand2} = (r[rs2] \text{ or } \text{sign_extnd}(\text{simm13}))$
 $n \leftarrow r[rd] \langle 31 \rangle$
 $z \leftarrow \text{if } r[rd] = 0 \text{ then } 1, \text{ else } 0$
 $v \leftarrow (r[rs1] \langle 31 \rangle \text{ AND not operand2} \langle 31 \rangle \text{ AND not } r[rd] \langle 31 \rangle)$
 OR $(\text{not } r[rs1] \langle 31 \rangle \text{ AND operand2} \langle 31 \rangle \text{ AND } r[rd] \langle 31 \rangle)$
 $c \leftarrow (\text{not } r[rs1] \langle 31 \rangle \text{ AND operand2} \langle 31 \rangle)$
 OR $(r[rd] \langle 31 \rangle \text{ AND } (\text{not } r[rs1] \langle 31 \rangle \text{ OR operand2} \langle 31 \rangle))$

Assembler

Syntax: `subcc regrs1, reg_or_imm, regrd`

Description:

The SUBcc instruction subtracts either the contents of register r[rs2] (if the instruction's *i* bit equals zero) or the 13-bit, sign-extended immediate operand contained in the instruction (if *i* equals one) from register r[rs1]. The result is placed in register r[rd]. In addition, SUBcc modifies all the integer condition codes in the manner described above.

Programming note: A SUBcc instruction with *rd* = 0 can be used for signed and unsigned integer comparison.

Traps:

none

Format:

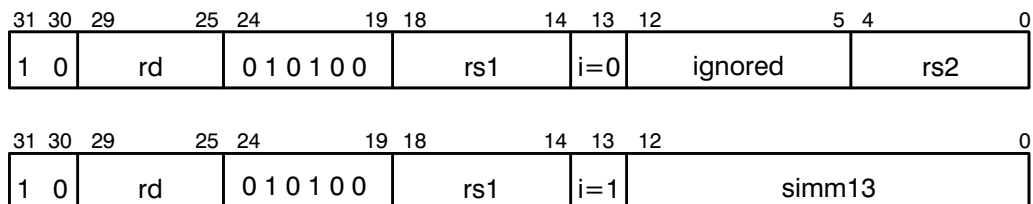

SUBX

Subtract with Carry

SUBX

Operation: $r[rd] \leftarrow r[rs1] - (r[rs2] \text{ or sign_extnd}(\text{simm13})) - c$

Assembler

Syntax: `subx reg_rs1, reg_or_imm, reg_rd`

Description: SUBX subtracts either the contents of register $r[rs2]$ (if the instruction's i bit equals zero) or the 13-bit, sign-extended immediate operand contained in the instruction (if i equals one) from register $r[rs1]$. It then subtracts the PSR's carry bit (c) from that result. The final result is placed in the register specified in the rd field.

Traps: none

Format:

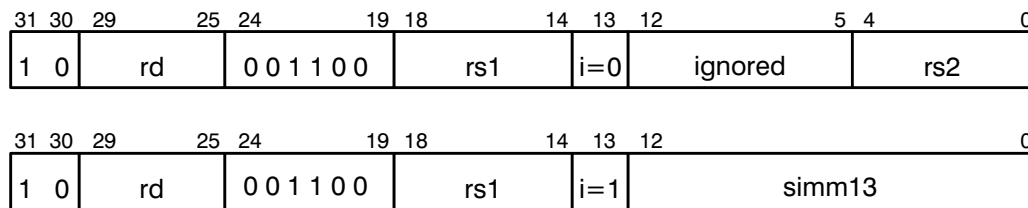

SUBXcc

Subtract with Carry and modify icc

SUBXcc

Operation: $r[rd] \leftarrow r[rs1] - \text{operand2} - c$, where $\text{operand2} = (r[rs2] \text{ or } \text{sign_extnd}(\text{simm13}))$
 $n \leftarrow r[rd] \langle 31 \rangle$
 $z \leftarrow \text{if } r[rd] = 0 \text{ then } 1, \text{ else } 0$
 $v \leftarrow (r[rs1] \langle 31 \rangle \text{ AND not } \text{operand2} \langle 31 \rangle \text{ AND not } r[rd] \langle 31 \rangle)$
 OR $(\text{not } r[rs1] \langle 31 \rangle \text{ AND } \text{operand2} \langle 31 \rangle \text{ AND } r[rd] \langle 31 \rangle)$
 $c \leftarrow (\text{not } r[rs1] \langle 31 \rangle \text{ AND } \text{operand2} \langle 31 \rangle)$
 OR $(r[rd] \langle 31 \rangle \text{ AND } (\text{not } r[rs1] \langle 31 \rangle \text{ OR } \text{operand2} \langle 31 \rangle))$

Assembler

Syntax: `subxcc regrs1, reg_or_imm, regrd`

Description: SUBXcc subtracts either the contents of register $r[rs2]$ (if the instruction's i bit equals zero) or the 13-bit, sign-extended immediate operand contained in the instruction (if i equals one) from register $r[rs1]$. It then subtracts the PSR's carry bit (c) from that result. The final result is placed in the register specified in the rd field. In addition, SUBXcc modifies all the integer condition codes in the manner described above.

Traps: none

Format:

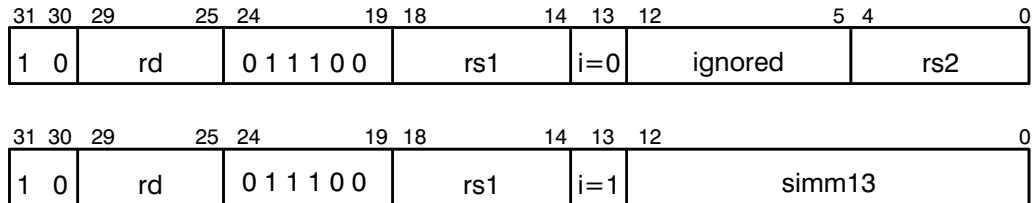

SWAP

Swap *r* register with memory

SWAP

Operation: word ← [r[rs1] + (r[rs2] or sign extnd(simm13))]
temp ← r[rd]
r[rd] ← word
r[rs1] + (r[rs2] or sign extnd(simm13)) ← temp

Assembler

Syntax: swap [source], reg_{rd}

Description: SWAP atomically exchanges the contents of r[rd] with the contents of a memory location, i.e., without allowing asynchronous trap interruptions. In a multiprocessor system, two or more processors executing SWAP instructions simultaneously are guaranteed to execute them serially, in some order. The effective memory address is derived by summing the contents of r[rs1] and either the contents of r[rs2] if the instruction's *i* bit equals zero, or the 13-bit, sign-extended immediate operand contained in the instruction if *i* equals one.

If SWAP takes a trap, the contents of the memory address and the destination register remain unchanged.

Programming note: If *rs1* is set to 0 and *i* is set to 1, any location in the lowest or highest 4 kbytes of an address space can be accessed without setting up a register.

Traps: memory_address_not_aligned
data_access_exception

Format:

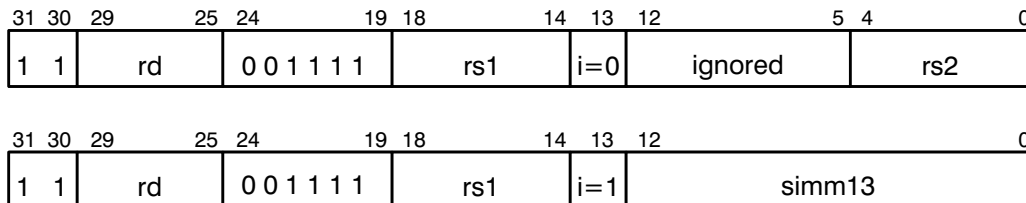

SWAPA Swap *r* register with memory in Alternate space **SWAPA**

(Privileged Instruction)

Operation: address space ← asi
 word ← [r[rs1] + r[rs2]]
 temp ← r[rd]
 r[rd] ← word
 [r[rs1] + r[rs2]] ← temp

Assembler

Syntax: swapa [*regsourc*] *asi*, *reg_{rd}*

Description: **SWAPA atomically exchanges the contents of r[rd] with the contents of a memory location, i.e., without allowing asynchronous trap interruptions. In a multiprocessor system, two or more processors executing SWAPA instructions simultaneously are guaranteed to execute them serially, in some order.**

The effective memory address is a combination of the address space value given in the *asi* field and the address derived by summing the contents of r[rs1] and r[rs2].

If SWAPA takes a trap, the contents of the memory address and the destination register remain unchanged.

Traps:

illegal_instruction (if i=1)
 privileged_instruction (if S=0)
 memory_address_not_aligned
 data_access_exception

Format:

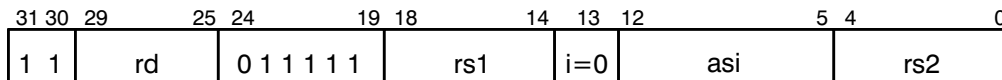

TADDcc

Tagged Add and modify icc

TADDcc

Operation: $r[rd] \leftarrow r[rs1] + \text{operand2}$, where $\text{operand2} = (r[rs2] \text{ or } \text{sign_extnd}(\text{simm13}))$
 $n \leftarrow r[rd]<31>$
 $z \leftarrow \text{if } r[rd]=0 \text{ then } 1, \text{ else } 0$
 $v \leftarrow (r[rs1]<31> \text{ AND } \text{operand2}<31> \text{ AND not } r[rd]<31>)$
 OR (not $r[rs1]<31>$ AND not $\text{operand2}<31>$ AND $r[rd]<31>$)
 OR ($r[rs1]<1:0> \neq 0$ OR $\text{operand2}<1:0> \neq 0$)
 $c \leftarrow (r[rs1]<31> \text{ AND } \text{operand2}<31>)$
 OR (not $r[rd]<31>$ AND ($r[rs1]<31>$ OR $\text{operand2}<31>$))

Assembler

Syntax: `taddcc regrs1, reg_or_imm, regrd`

Description: TADDcc adds the contents of $r[rs1]$ to either the contents of $r[rs2]$ if the instruction's i bit equals zero, or to a 13-bit, sign-extended immediate operand if i equals one. The result is placed in the register specified in the rd field. In addition to the normal arithmetic overflow, an overflow condition also exists if bit 1 or bit 0 of either operand is not zero. TADDcc modifies all the integer condition codes in the manner described above.

Traps: none

Format:



TADDccTV Tagged Add (modify icc) Trap on Overflow TADDccTV

Operation: result \leftarrow r[rs1] + operand2, where operand 2 = (r[rs2] or sign extnd(simm13))
 tv \leftarrow (r[rs1]<31> AND operand2<31> AND not r[rd]<31>)
 OR (not r[rs1]<31> AND not operand2<31> AND r[rd]<31>)
 OR (r[rs1]<1:0> \neq 0 OR operand2<1:0> \neq 0)
 if tv = 1, then tag overflow trap; else
 n \leftarrow r[rd]<31>
 z \leftarrow if r[rd]=0 then 1, else 0
 v \leftarrow tv
 c \leftarrow (r[rs1]<31> AND operand2<31>
 OR (not r[rd]<31> AND (r[rs1]<31> OR operand2<31>))
 r[rd] \leftarrow result

Assembler

Syntax: taddcctv *reg_{rs1}*, *reg_or_imm*, *reg_{rd}*

Description:

TADDccTV adds the contents of r[rs1] to either the contents of r[rs2] if the instruction’s *i* bit equals zero, or to a 13-bit, sign-extended immediate operand if *i* equals one. In addition to the normal arithmetic overflow, an overflow condition also exists if bit 1 or bit 0 of either operand is not zero. If TADDccTV detects an overflow condition, a tag_overflow trap is generated and the destination register and condition codes remain unchanged. If no overflow is detected, TADDccTV places the result in the register specified in the *rd* field and modifies all the integer condition codes in the manner described above (the overflow bit is, of course, set to zero).

Traps:

tag_overflow

Format:



Ticc

Trap on integer condition codes

Ticc

Operation: If condition true, then trap_instruction;
 $tt \leftarrow 128 + [r[rs1] + (r[rs2] \text{ or sign extnd(simm13))]<6:0>$
 else PC \leftarrow nPC
 nPC \leftarrow nPC + 4

Assembler

Syntax:

ta{,a}	label	
tn{,a}	label	
tne{,a}	label	synonym: tnz
te{,a}	label	synonym: tz
tg{,a}	label	
tle{,a}	label	
tge{,a}	label	
tl{,a}	label	
tgu{,a}	label	
tleu{,a}	label	
tcc{,a}	label	synonym: tgeu
tcs{,a}	label	synonym: tlu
tpos{,a}	label	
tneg{,a}	label	
tvc{,a}	label	
tvsv{,a}	label	

Description: A Ticc instruction evaluates specific integer condition code combinations (from the PSR's *icc* field) based on the trap type as specified by the value in the instruction's *cond* field. If the specified combination of condition codes evaluates as true, and there are no higher-priority traps pending, then a trap_instruction trap is generated. If the condition codes evaluate as false, the trap is not generated.

If a trap_instruction trap is generated, the *tt* field of the Trap Base Register (TBR) is written with 128 plus the least significant seven bits of r[rs1] plus either r[rs2] (bit field *i* = 0) or the 13-bit sign-extended immediate value contained in the instruction (bit field *i* = 1). See Section NO TAG for the complete definition of a trap.

Traps: trap_instruction

Ticc

Trap on integer condition codes

Ticc

Mnemonic	Cond.	Operation	icc Test
TN	0000	Trap Never	No test
TE	0001	Trap on Equal	z
TLE	0010	Trap on Less or Equal	z OR (n XOR v)
TL	0011	Trap on Less	n XOR v
TLEU	0100	Trap on Less or Equal, Unsigned	c OR z
TCS	0101	Trap on Carry Set (Less then, Unsigned)	c
TNEG	0110	Trap on Negative	n
TVS	0111	Trap on oVerflow Set	v
TA	1000	Trap Always	No test
TNE	1001	Trap on Not Equal	not z
TG	1010	Trap on Greater	not(z OR (n XOR v))
TGE	1011	Trap on Greater or Equal	not(n XOR v)
TGU	1100	Trap on Greater, Unsigned	not(c OR z)
TCC	1101	Trap on Carry Clear (Greater than or Equal, Unsigned)	not c
TPOS	1110	Trap on Positive	not n
TVC	1111	Trap on oVerflow Clear	not v

Format:

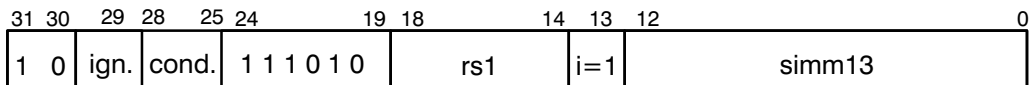
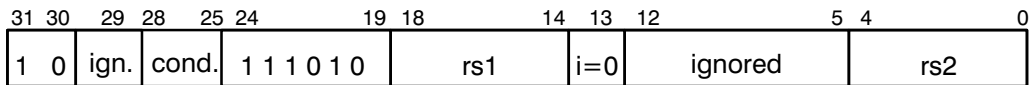

ign. = ignored
cond. = condition

TSUBcc

Tagged Subtract and modify icc

TSUBcc

Operation: $r[rd] \leftarrow r[rs1] - \text{operand2}$, where $\text{operand2} = (r[rs2] \text{ or sign extnd}(\text{simm13}))$
 $n \leftarrow r[rd]<31>$
 $z \leftarrow \text{if } r[rd]=0 \text{ then } 1, \text{ else } 0$
 $v \leftarrow (r[rs1]<31> \text{ AND not operand2}<31> \text{ AND not } r[rd]<31>) \text{ OR } (\text{not } r[rs1]<31> \text{ AND operand2}<31> \text{ AND } r[rd]<31>) \text{ OR } (r[rs1]<1:0> \neq 0 \text{ OR operand2}<1:0> \neq 0)$
 $c \leftarrow (\text{not } r[rs1]<31> \text{ AND operand2}<31> \text{ OR } (r[rd]<31> \text{ AND } (\text{not } r[rs1]<31> \text{ OR operand2}<31>))$

Assembler

Syntax: `tsubcc reg_rs1, reg_or_imm, reg_rd`

Description: TSUBcc subtracts either the contents of register $r[rs2]$ (if the instruction's i bit equals zero) or the 13-bit, sign-extended immediate operand contained in the instruction (if i equals one) from register $r[rs1]$. The result is placed in the register specified in the rd field. In addition to the normal arithmetic overflow, an overflow condition also exists if bit 1 or bit 0 of either operand is not zero. TSUBcc modifies all the integer condition codes in the manner described above.

Traps: none

Format:

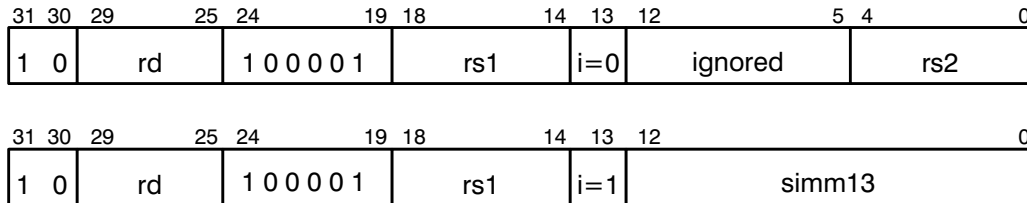

TSUBccTV

Tagged Subtract (modify icc)

TSUBccTV

Trap on Overflow

Operation: result ← r[rs1] - operand2, where operand2 = (r[rs2] or sign extnd(simm13))
 tv ← (r[rs1]<31> AND not operand2<31> AND not r[rd]<31>) OR (not r[rs1]<31>
 AND operand2<31> AND r[rd]<31>)
 OR (r[rs1]<1:0> ≠ 0 OR operand2<1:0> ≠ 0)
 if tv = 1, then tag overflow trap; else
 n ← r[rd]<31>
 z ← if r[rd]=0 then 1, else 0
 v ← tv
 c ← (not(r[rs1]<31>) AND operand2<31> OR
 (r[rd]<31> AND (not(r[rs1]<31>) OR operand2<31>))
 r[rd] ← result

Assembler

Syntax: tsubcctv *reg_{rs1}, reg_or_imm, reg_{rd}*

Description:

TSUBccTV subtracts either the contents of register r[rs2] (if the instruction's *i* bit equals zero) or the 13-bit, sign-extended immediate operand contained in the instruction (if *i* equals one) from register r[rs1]. In addition to the normal arithmetic overflow, an overflow condition also exists if bit 1 or bit 0 of either operand is not zero.

If TSUBccTV detects an overflow condition, a tag_overflow trap is generated and the destination register and condition codes remain unchanged. If no overflow is detected, TSUBccTV places the result in the register specified in the *rd* field and modifies all the integer condition codes in the manner described above (the overflow bit is, of course, set to zero).

Traps:

tag_overflow

Format:



UNIMP

Unimplemented instruction

UNIMP

Operation: illegal instruction trap

Assembler

Syntax: unimp *const22*

Description: Executing the UNIMP instruction causes an immediate illegal_instruction trap. The value in the const22 field is ignored.

Programming note: UNIMP can be used as part of the protocol for calling a function that is expected to return an aggregate value, such as a C-language structure.

1. An UNIMP instruction is placed after (not in) the delay slot after the CALL instruction in the calling function.
2. If the called function is expecting to return a structure, it will find the size of the structure that the caller expects to be returned as the const22 operand of the UNIMP instruction. The called function can check the opcode to make sure it is indeed UNIMP.
3. If the function is not going to return a structure, upon returning, it attempts to execute UNIMP rather than skipping over it as it should. This causes the program to terminate. The behavior adds some run-time checking to an interface that cannot be checked properly at compile time.

Traps: illegal_instruction

Format:

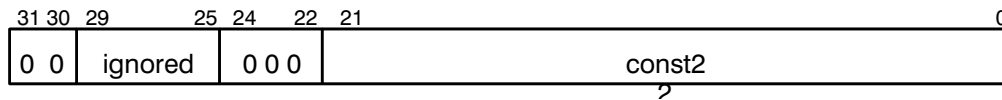

WRPSR

Write Processor State Register

WRPSR

(Privileged Instruction)

Operation: PSR ← r[rs1] XOR (r[rs2] or sign extnd(simm13))

Assembler

Syntax: wr *reg_rs1, reg_or_imm, %psr*

Description: WRPSR does a bitwise logical XOR of the contents of register r[rs1] with either the contents of r[rs2] (if bit field i=0) or the 13-bit sign-extended immediate value contained in the instruction (if bit field i=1). The result is written into the writable subfields of the PSR. However, if the result's CWP field would point to an unimplemented window, an illegal_instruction trap is generated and the PSR remains unchanged.

WRPSR is a delayed-write instruction:

1. If any of the three instructions following a WRPSR uses any PSR field that WRPSR modified, the value of that field is unpredictable. Note that any instruction which references a non-global register makes use of the CWP, so following WRPSR with three NOPs would be the safest course.
2. If a WRPSR instruction is updating the PSR's Processor Interrupt Level (PIL) to a new value and is simultaneously setting Enable Traps (ET) to one, this could result in an interrupt trap at a level equal to the old PIL value.
3. If any of the three instructions after a WRPSR instruction reads the modified PSR, the value read is unpredictable.
4. If any of the three instructions after a WRPSR is trapped, a subsequent RDPSR in the trap handler will get the register's new value.

Programming note: Two WRPSR instructions should be used when enabling traps and changing the PIL value. The first WRPSR should specify ET=0 with the new PIL value, and the second should specify ET=1 with the new PIL value.

Traps: illegal_instruction
privileged_instruction (if S=0)

Format:

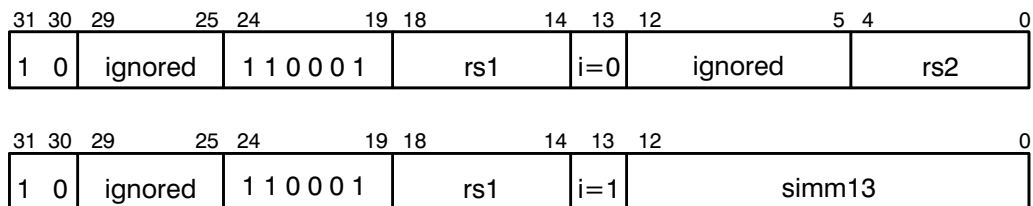

WRTBR

**Write Trap Base Register
(Privileged Instruction)**

WRTBR

Operation: TBR ← r[rs1] XOR (r[rs2] or sign_extnd(simm13))

Assembler

Syntax: wr *reg_rs1*, *reg_or_imm*, %tbr

Description: WRTBR does a bitwise logical XOR of the contents of register r[rs1] with either the contents of r[rs2] (if bit field i=0) or the 13-bit sign-extended immediate value contained in the instruction (if bit field i=1). The result is written into the Trap Base Address field of the TBR.

WRTBR is a delayed-write instruction:

1. If any of the three instructions following a WRTBR causes a trap, the TBA used may be either the old or the new value.
2. If any of the three instructions after a WRTBR is trapped, a subsequent RDTBR in the trap handler will get the register's new TBA value.

Traps: privileged_instruction (if S=0)

Format:

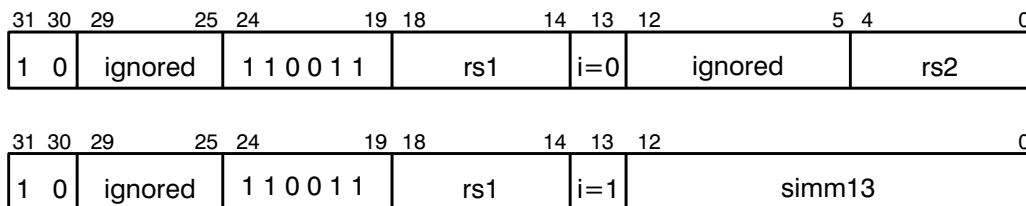

WRWIM

Write Window Invalid Mask register

WRWIM

(Privileged Instruction)

Operation: $WIM \leftarrow r[rs1] \text{ XOR } (r[rs2] \text{ or sign extnd(simm13)})$

Assembler

Syntax: `wr reg_rs1, reg_or_imm, %wim`

Description: WRWIM does a bitwise logical XOR of the contents of register r[rs1] with either the contents of r[rs2] (if bit field i=0) or the 13-bit, sign-extended immediate value contained in the instruction (if bit field i=1). The result is written into the writable bits of the WIM register.

WRWIM is a delayed-write instruction:

1. If any of the three instructions following a WRWIM is a SAVE, RESTORE, or RETT, the occurrence of window_overflow and window_underflow is unpredictable.
2. If any of the three instructions after a WRWIM instruction reads the modified WIM, the value read is unpredictable.
3. If any of the three instructions after a WRWIM is trapped, a subsequent RDWIM in the trap handler will get the register's new value.

Traps: privileged_instruction (if S=0)

Format:



WRY

Write Y register

WRY

Operation: $Y \leftarrow r[rs1] \text{ XOR } (r[rs2] \text{ or sign extnd(simm13)})$

Assembler

Syntax: `wr reg_rs1, reg_or_imm, %y`

Description: WRY does a bitwise logical XOR of the contents of register r[rs1] with either the contents of r[rs2] (if bit field i=0) or the 13-bit, sign-extended immediate value contained in the instruction (if bit field i=1). The result is written into the Y register.

WRY is a delayed-write instruction:

1. If any of the three instructions following a WRY is a MULScc or a RDY, the value of Y used is unpredictable.
2. If any of the three instructions after a WRY instruction reads the modified Y register, the value read is unpredictable.
3. If any of the three instructions after a WRY is trapped, a subsequent RDY in the trap handler will get the register's new value.

Traps: none

Format:

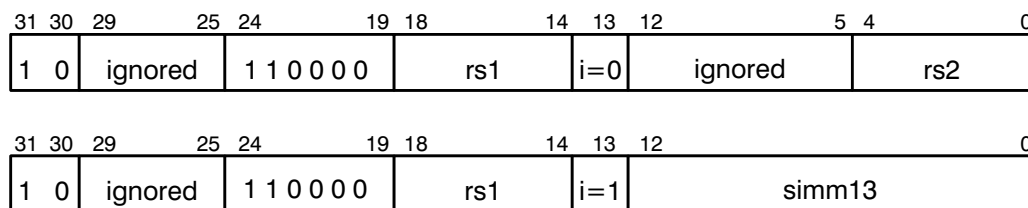

XNOR

Exclusive-Nor

XNOR

Operation: $r[rd] \leftarrow r[rs1] \text{ XOR not}(r[rs2] \text{ or sign extnd}(\text{simm13}))$

Assembler

Syntax: `xnor regrs1, reg_or_imm, regrd`

Description: This instruction does a bitwise logical XOR of the contents of register r[rs1] with the one's complement of either the contents of r[rs2] (if bit field i=0) or the 13-bit sign-extended immediate value contained in the instruction (if bit field i=1). The result is stored in register r[rd].

Traps: none

Format:

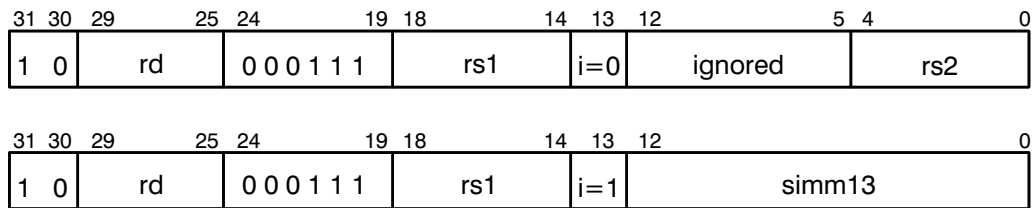

XNORcc

Exclusive-Nor and modify icc

XNORcc

Operation: $r[rd] \leftarrow r[rs1] \text{ XOR not}(r[rs2] \text{ or sign extnd}(\text{simm13}))$
 $n \leftarrow r[rd] < 31 >$
 $z \leftarrow \text{if } r[rd] = 0 \text{ then } 1, \text{ else } 0$
 $v \leftarrow 0$
 $c \leftarrow 0$

Assembler

Syntax: `xnorcc reg_rs1, reg_or_imm, reg_rd`

Description: This instruction does a bitwise logical XOR of the contents of register r[rs1] with the one's complement of either the contents of r[rs2] (if bit field i=0) or the 13-bit, sign-extended immediate value contained in the instruction (if bit field i=1). The result is stored in register r[rd]. XNORcc also modifies all the integer condition codes in the manner described above.

Traps: none

Format:

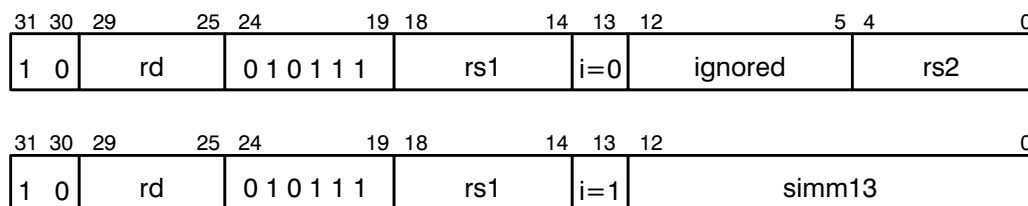

XOR

Exclusive-Or

XOR

Operation: $r[rd] \leftarrow r[rs1] \text{ XOR } (r[rs2] \text{ or sign extnd(simm13)})$

Assembler

Syntax: `xor regrs1, reg_or_imm, regrd`

Description: This instruction does a bitwise logical XOR of the contents of register r[rs1] with either the contents of r[rs2] (if bit field i=0) or the 13-bit, sign-extended immediate value contained in the instruction (if bit field i=1). The result is stored in register r[rd].

Traps: none

Format:

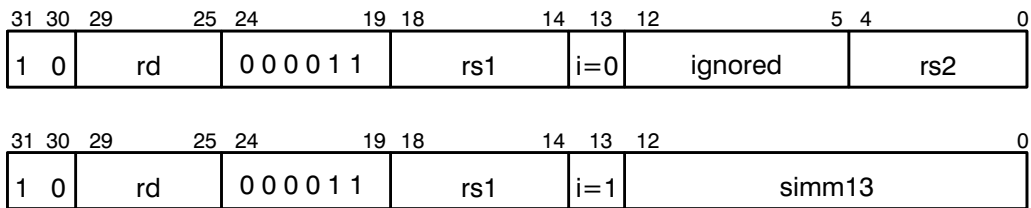

XORcc

Exclusive-OR and modify icc

XORcc

Operation: $r[rd] \leftarrow r[rs1] \text{ XOR } (r[rs2] \text{ or sign extnd}(\text{simm13}))$
 $n \leftarrow r[rd] < 31 >$
 $z \leftarrow \text{if } r[rd] = 0 \text{ then } 1, \text{ else } 0$
 $v \leftarrow 0$
 $c \leftarrow 0$

Assembler

Syntax: `xorcc reg_rs1, reg_or_imm, reg_rd`

Description: This instruction does a bitwise logical XOR of the contents of register r[rs1] with either the contents of r[rs2] (if bit field i=0) or the 13-bit, sign-extended immediate value contained in the instruction (if bit field i=1). The result is stored in register r[rd]. XORcc also modifies all the integer condition codes in the manner described above.

Traps: none

Format:

