

Lecture 12: Photographic Optics

Yuhao Zhu

<http://yuhaozhu.com>
yzhu@rochester.edu

CSC 259/459, Fall 2024
Computer Imaging & Graphics

The Roadmap

Theoretical Preliminaries

Human Visual Systems

Digital Camera Imaging

Modeling and Rendering



Photographic Optics

Image Sensor

Image Signal Processing

Image/Video Compression

Immersive Content

Digital Cameras

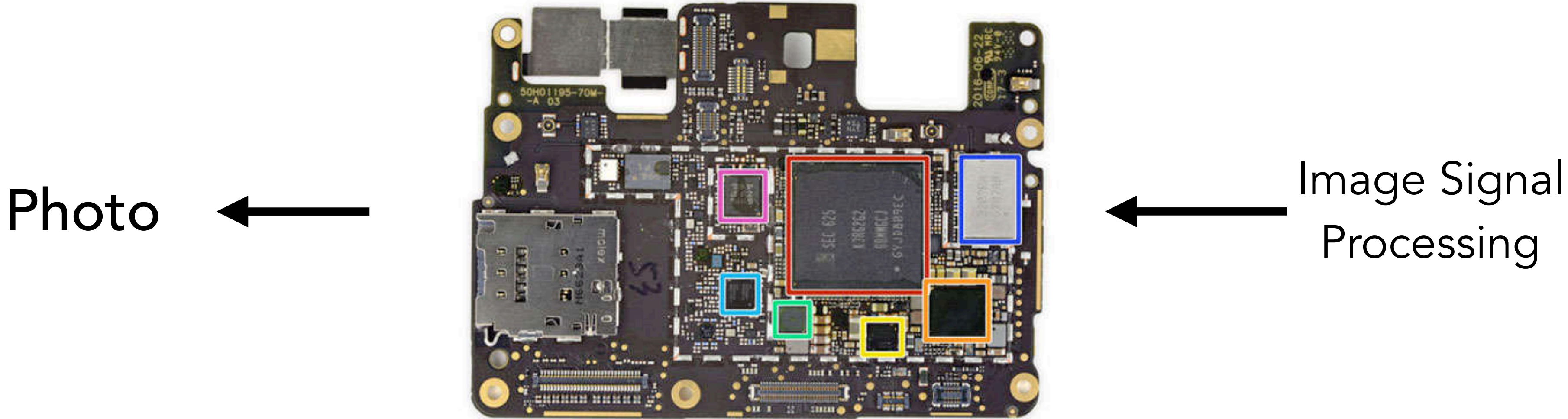
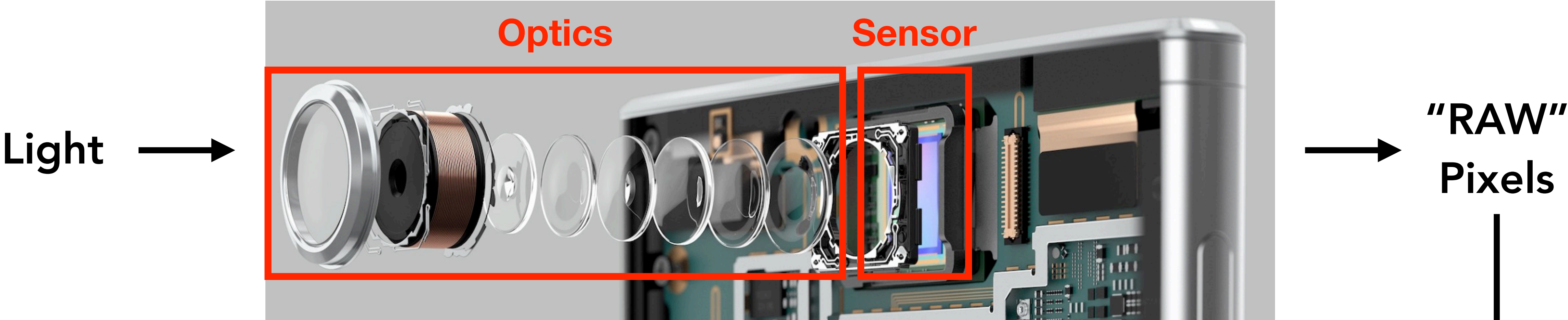

<https://ph.priceprice.com/Google-Pixel-XL-18713/news/Google-Pixel-XL-Repair-1939/>

**Why Do Cameras
Need Lenses Anyway?**

Just Expose Sensor to Scene Without Optics



Just Expose Sensor to Scene Without Optics

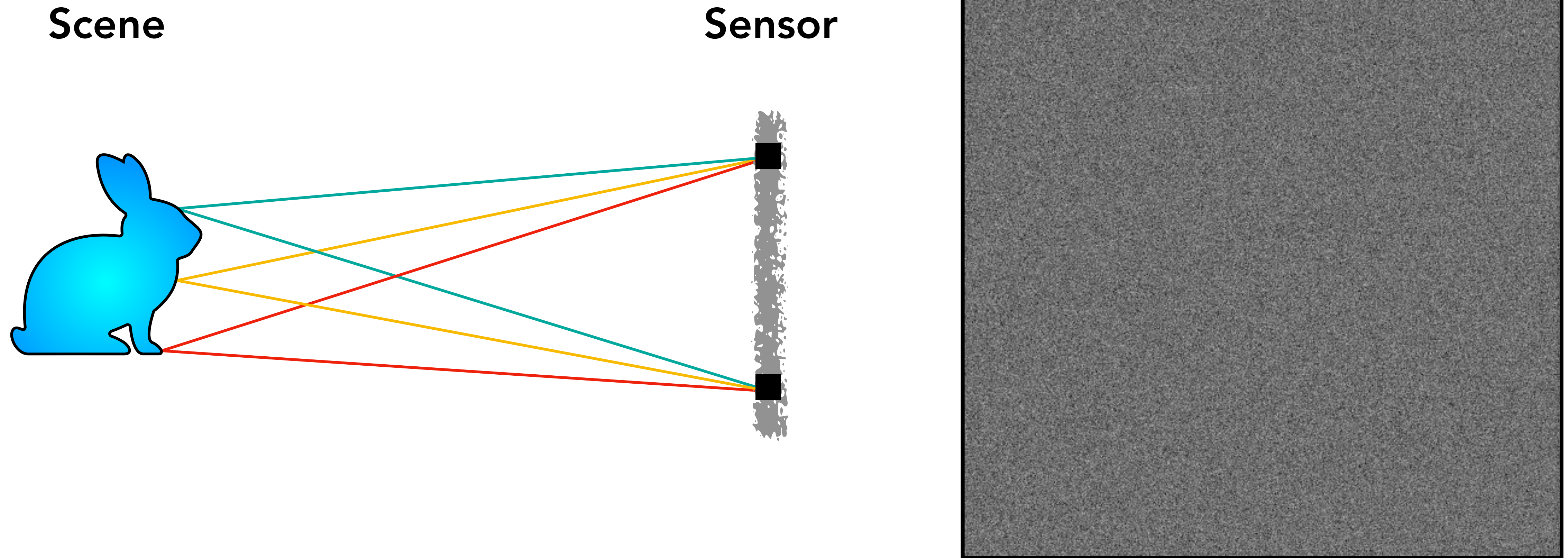

Pinhole Camera

Ideally: Each pixel on the sensor gets light from only one scene point.

Use a **very** small hole as the **aperture**.

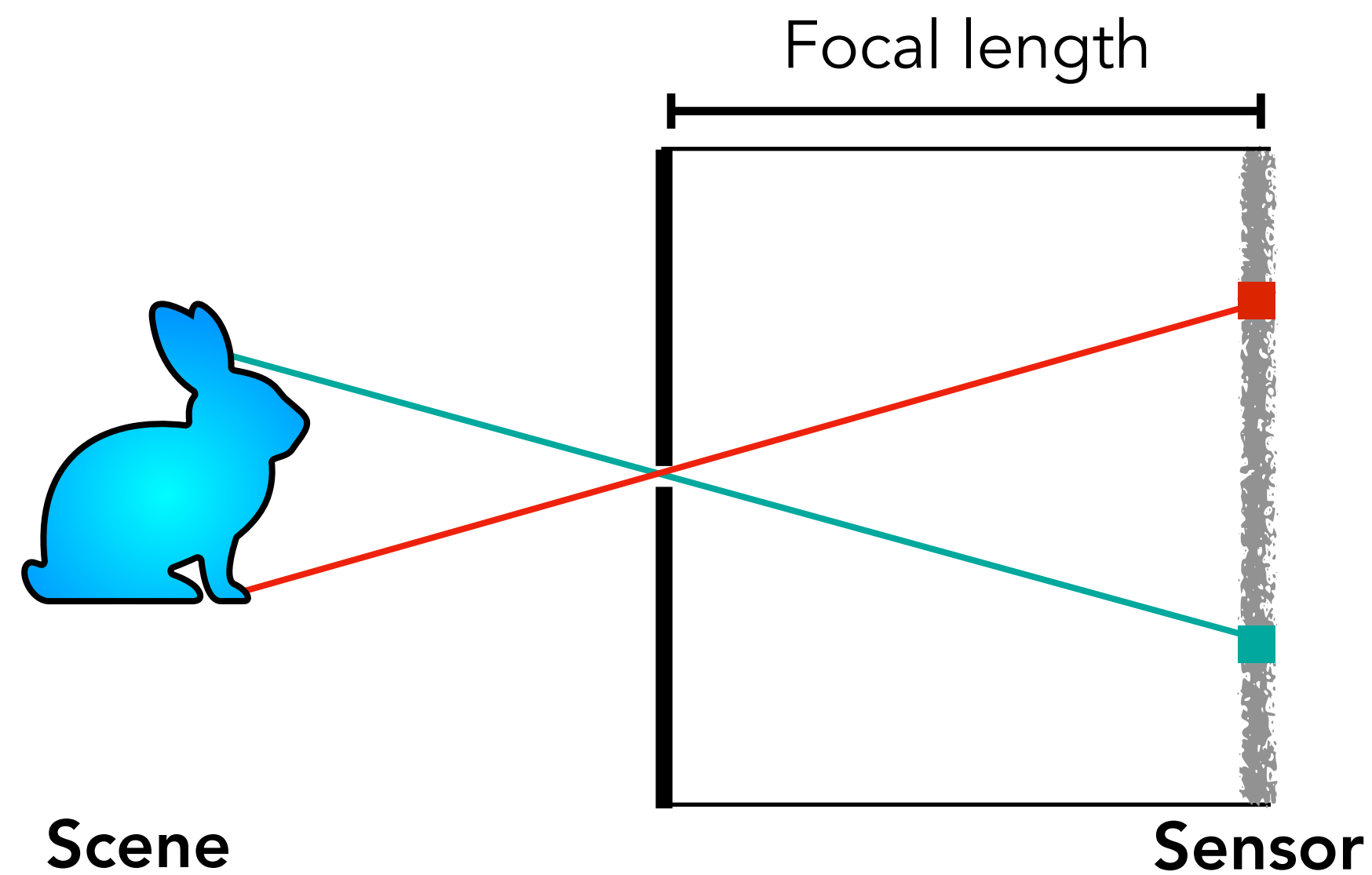





Pinhole size: 0.45mm
Focal length: 126mm



Long Exposure Time

A small pinhole allows only very small amount of light to enter, requiring very long exposure time; impractical for many scenarios.

	Sunny	15 to 20 seconds
	Overcast	60 seconds
	Cloudy	2 minutes
	Indoors	30 minutes to an hour
	Nighttime	A few hours



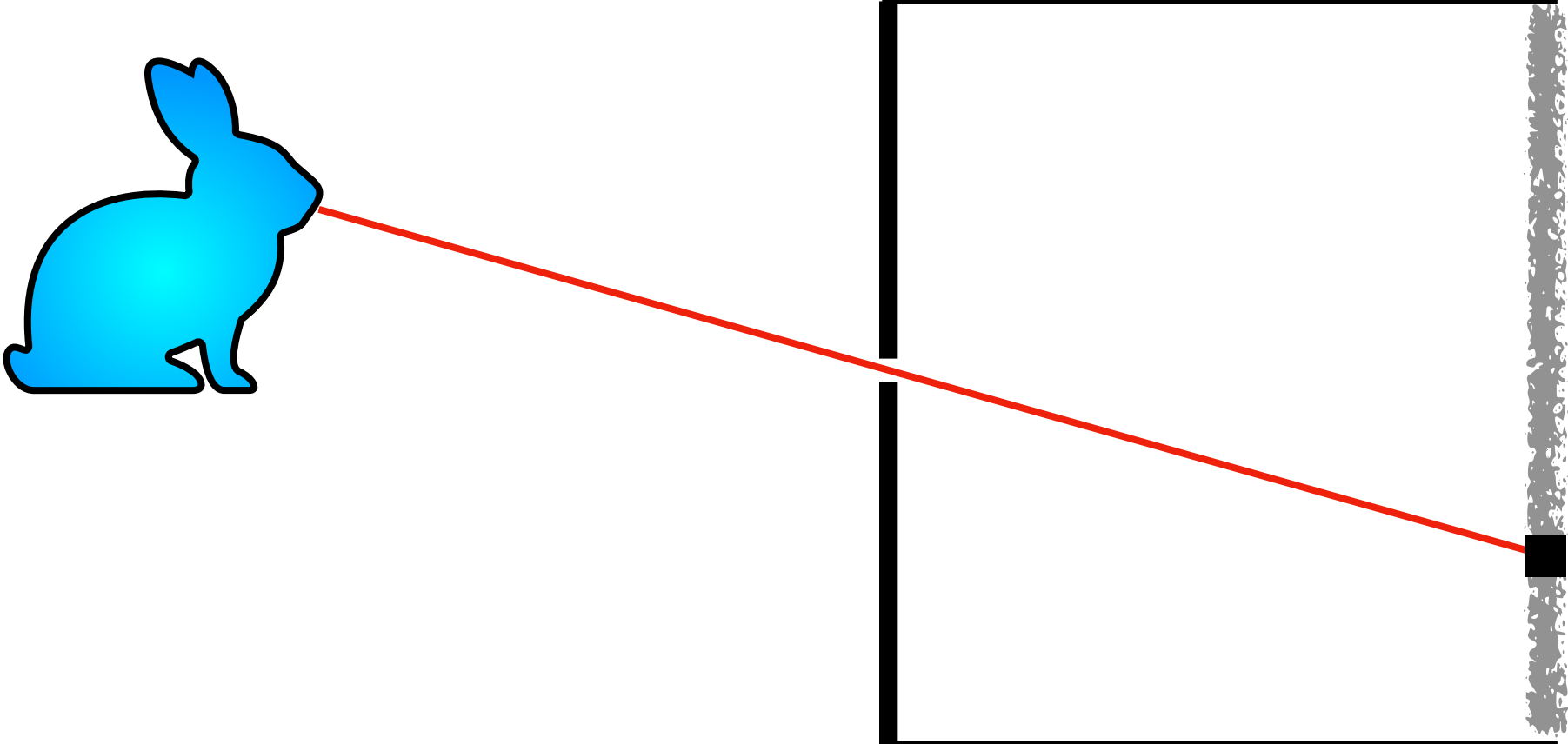

*these will differ under many conditions so you'll be experimenting as you go.
Keep track of exposure times so you can make your own more detailed chart.

www.lilblueboo.com/pinhole-photography

Long Exposure Time Motion Blur



Wide Angle Pinhole Sample Exposure Times*

	Sunny	15 to 20 seconds
	Overcast	60 seconds
	Cloudy	2 minutes
	Indoors	30 minutes to an hour
	Nighttime	A few hours

*these will differ under many conditions so you'll be experimenting as you go.
Keep track of exposure times so you can make your own more detailed chart.

www.lilblueboo.com/pinhole-photography



Large Pinhole?

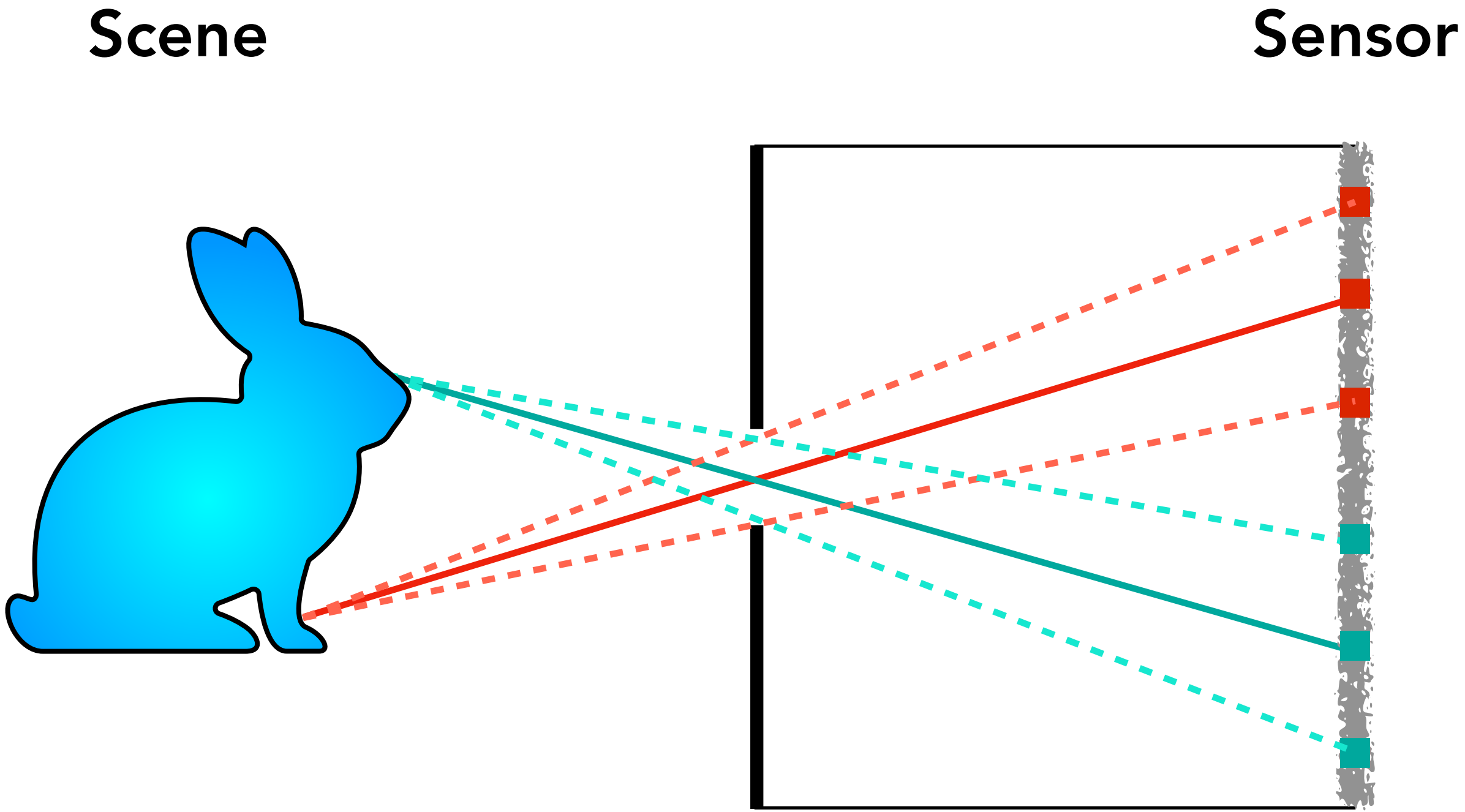

What's happening here?

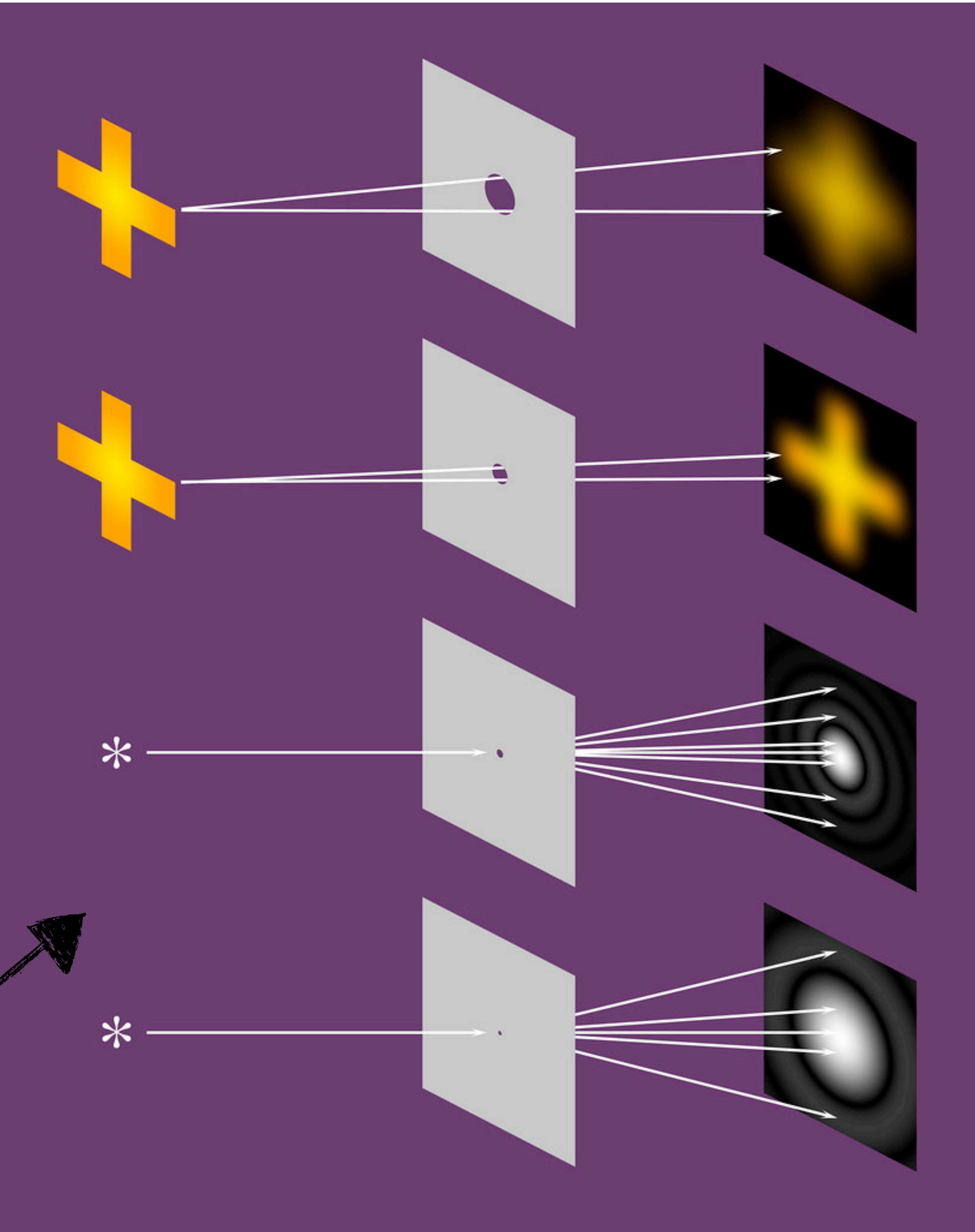

Not All Blurs Are Created Equal

Blur From Large Aperture
("Defocus" Blur)



Motion Blur



Imaging With a Convex Lens

A point in the scene emits (or reflects) rays in all directions.

- A pinhole camera captures just one ray from the point.

A convex lens captures/focuses a lot of rays from the same point and sends them to the same pixel on the sensor.

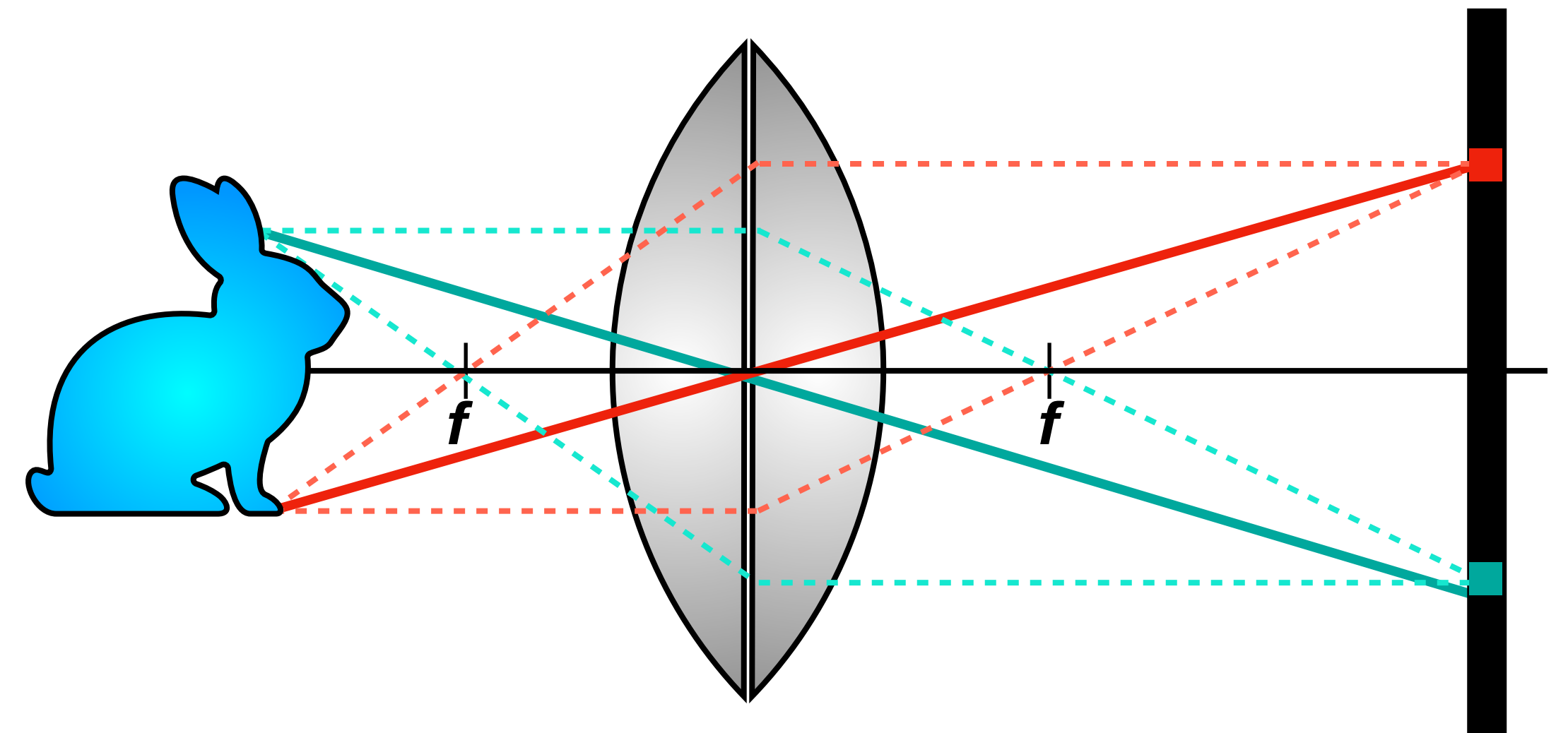

The Image is the Same As With a Pinhole Camera

If **in focus**, the captured image is the geometrically the same as the one captured by a pinhole camera, but brighter given the same exposure time.

- ...under the thin lens and paraxial approximations (later)
- Both are **perspective projection**

This's why we can **approximate** image formation process of a lens-based camera using a pinhole camera model.

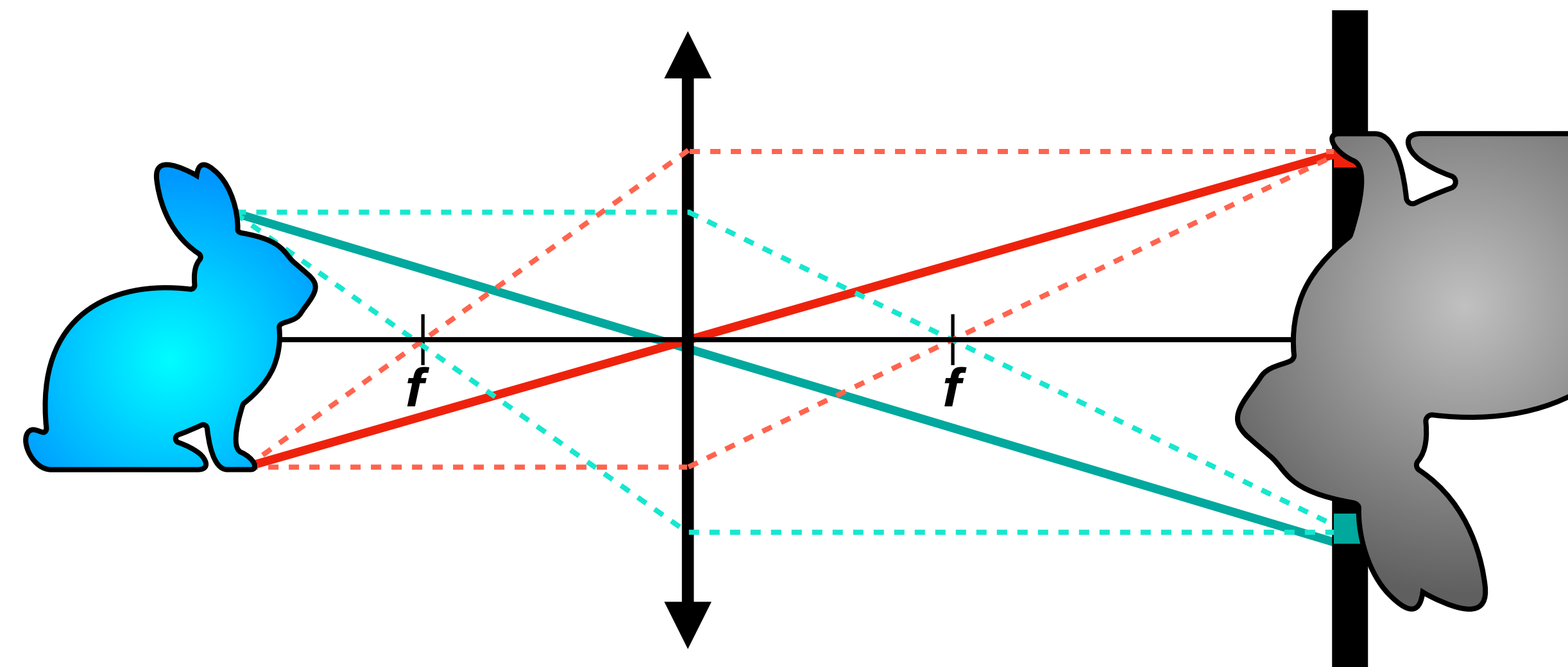

Making Convex Lens

The simplest way: combining two spherical lenses, which are easy to make.



Polishing a spherical lens. (Optical Society of America)

Aperture

Aperture limits the amount of light that pass through the lens.

Amount of photons allowed through is proportional to the aperture area (radius²)

Aperture size has implications on exposure time, motion blur, and depth of field (more on this later).

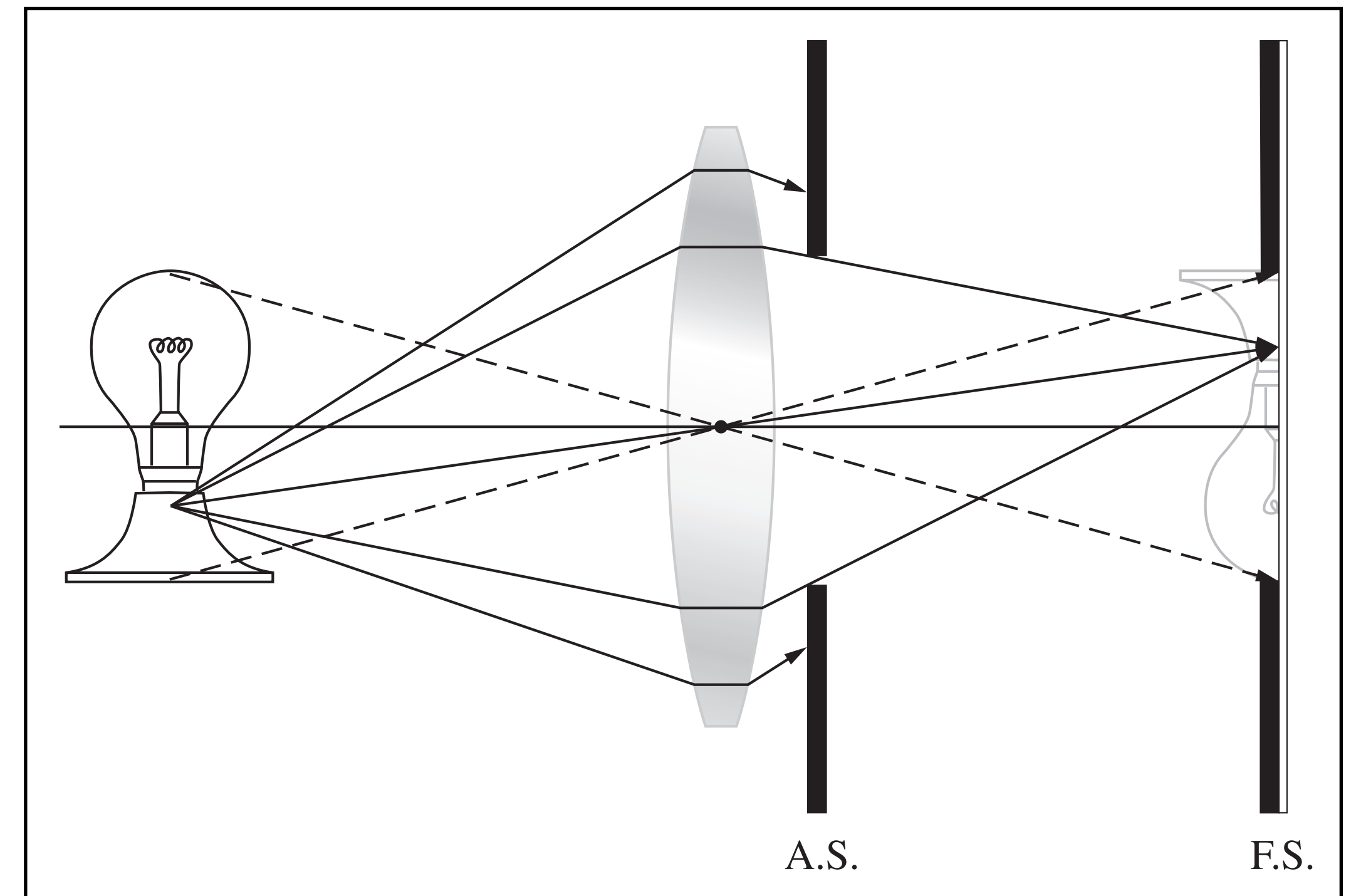

Shutter

Shutter controls how sensor is exposed to light

Mechanical shutter:

- Sensor is **unexposed** to light normally
- Shutter mechanically opens to expose sensor to light
- Shutter open size dictates exposure time
- Focal plane shutter is common these days; inherently a rolling shutter

Electronic shutter (next lecture):

- Sensor is always **exposed** to light
- The pixel circuit resets/drains a pixel's charges to prepare for a capture
- Can be either rolling or global shutter

Mechanical Shutter

Leaf shutter (usually at the aperture plane)

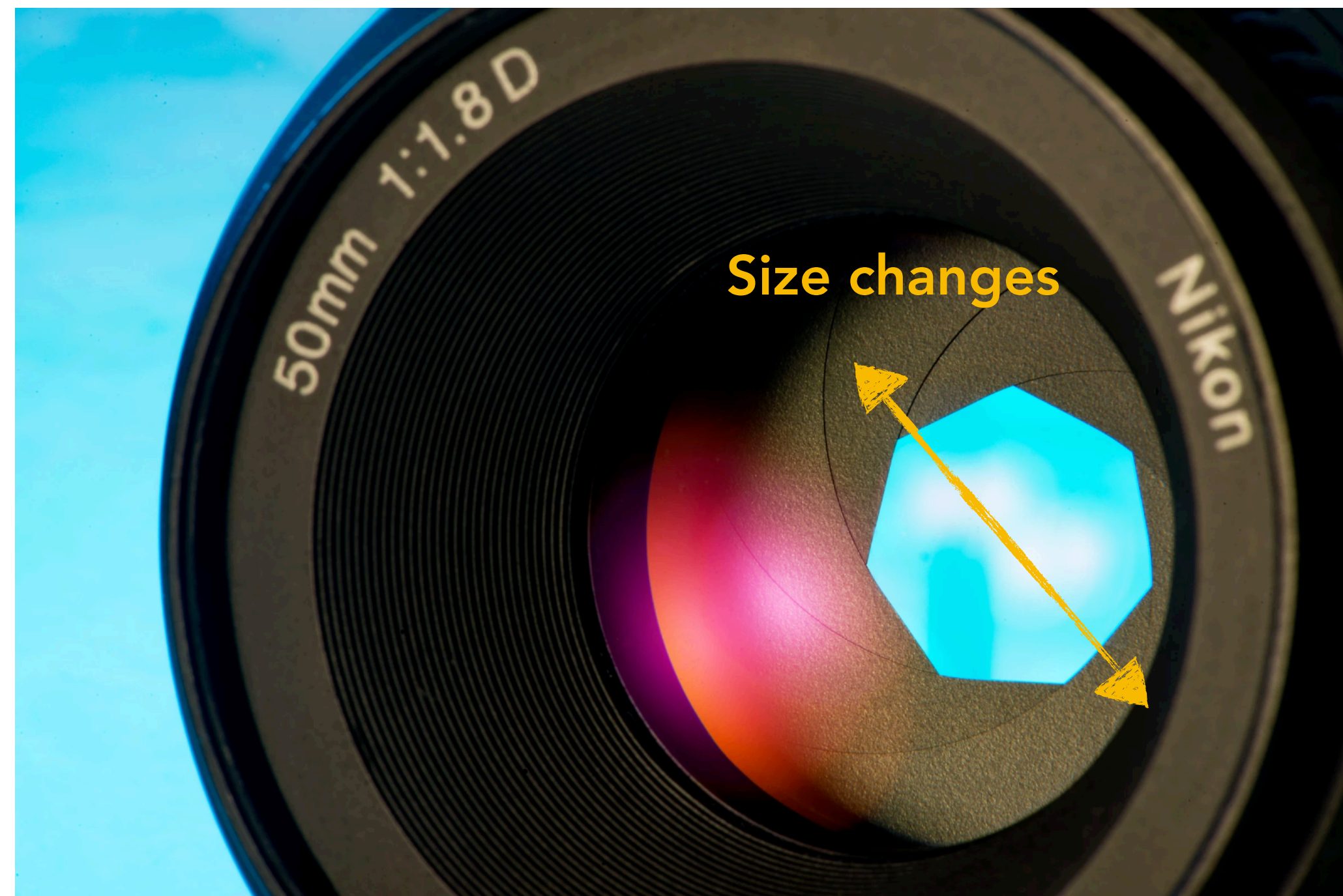

Focal plane shutter (at the focal plane)

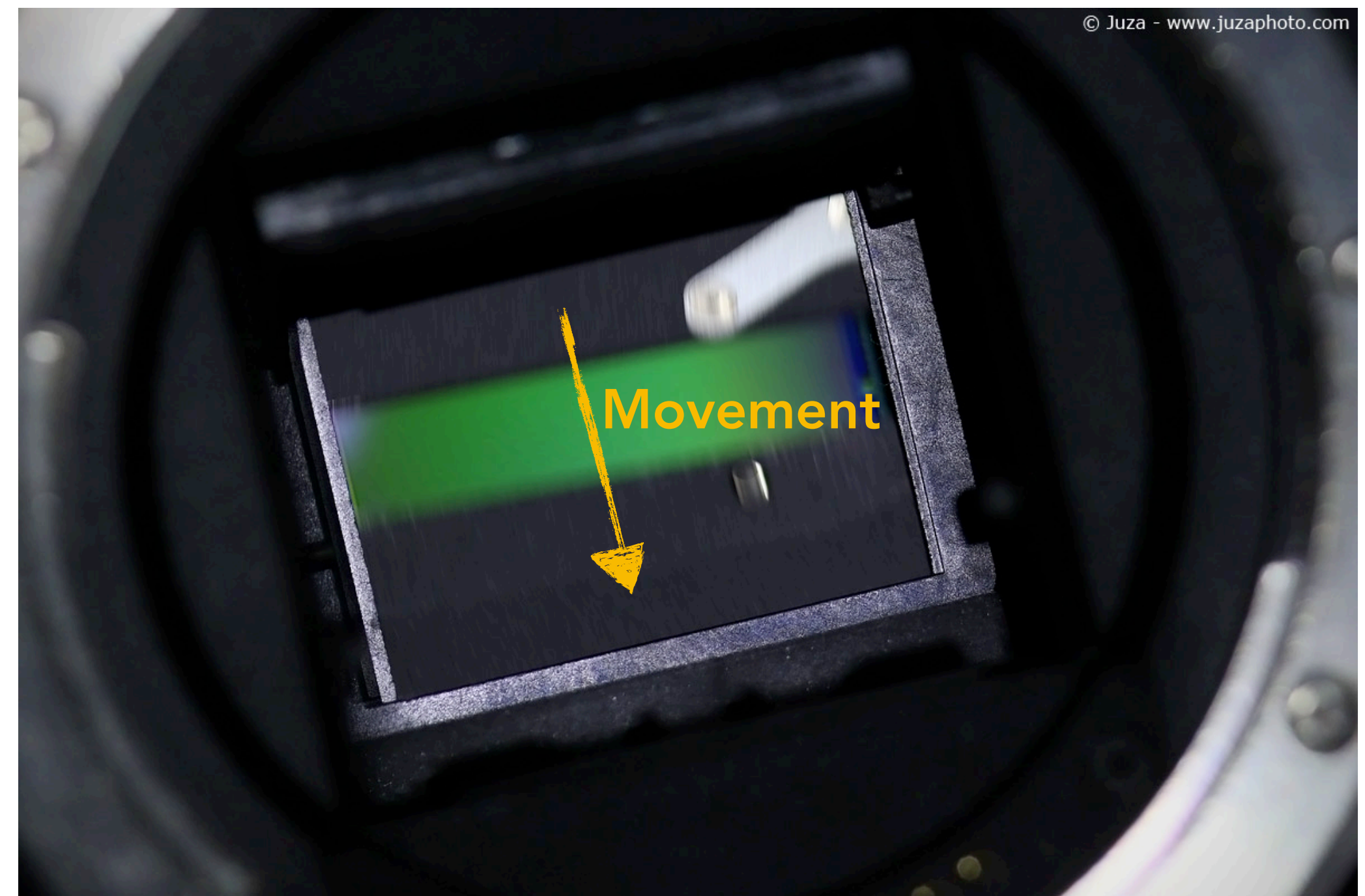

Focal Plane Shutter (Fast Exposures)

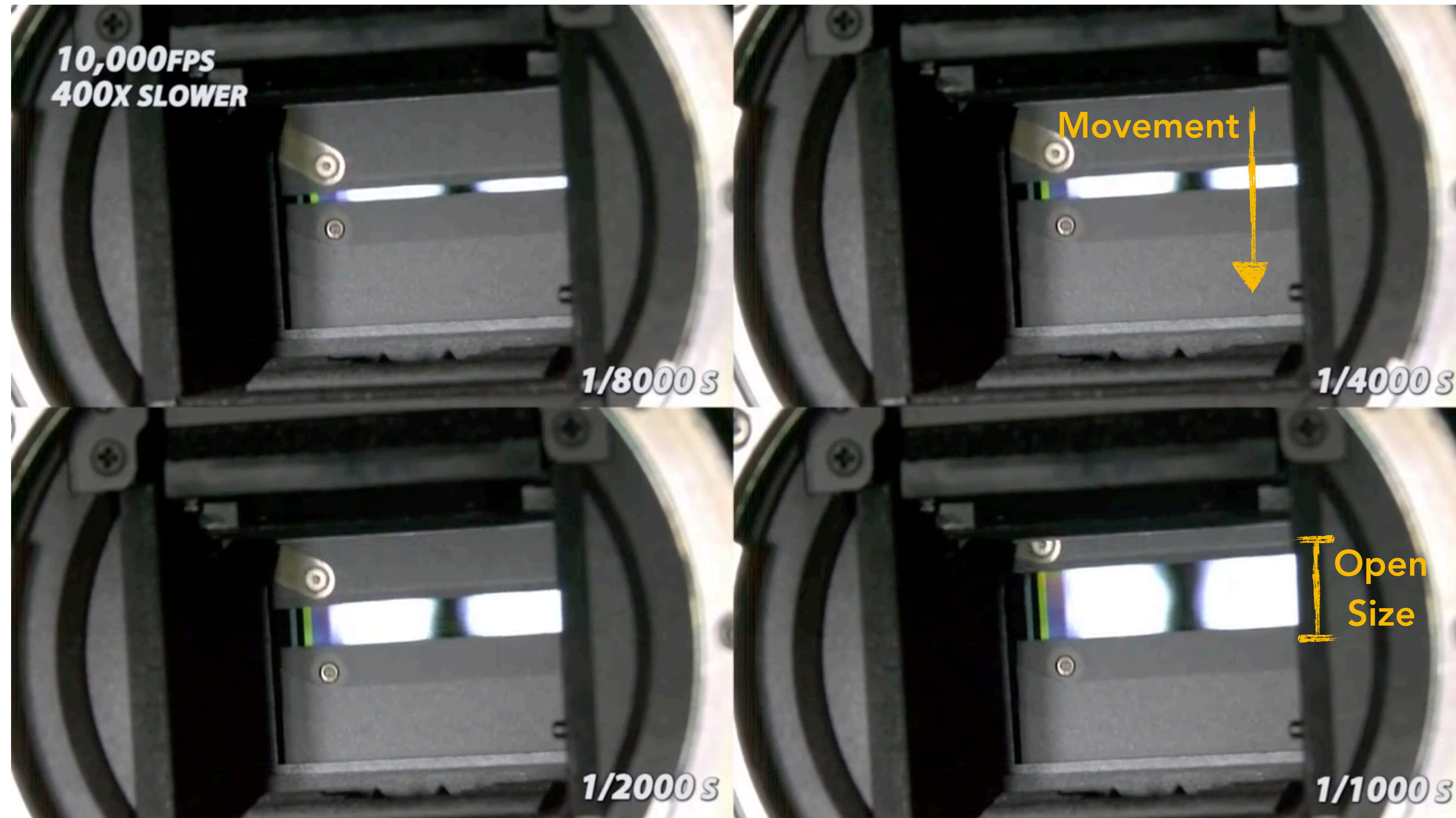

Inherently a rolling shutter

Exposure time is dictated by the shutter open size

The Slow Mo Guys, <https://youtu.be/CmjeCchGRQo>

Modeling Lens Behaviors

Why Does Convex Lens Focus Light?

Lenses don't magically bend lights.

Lights change direction going through media of different refractive indices.

- Air to glass and glass to air again here.
- Again, lights changing direction at medium interface is macroscopic behavior of particles **scattering** photons with interference.

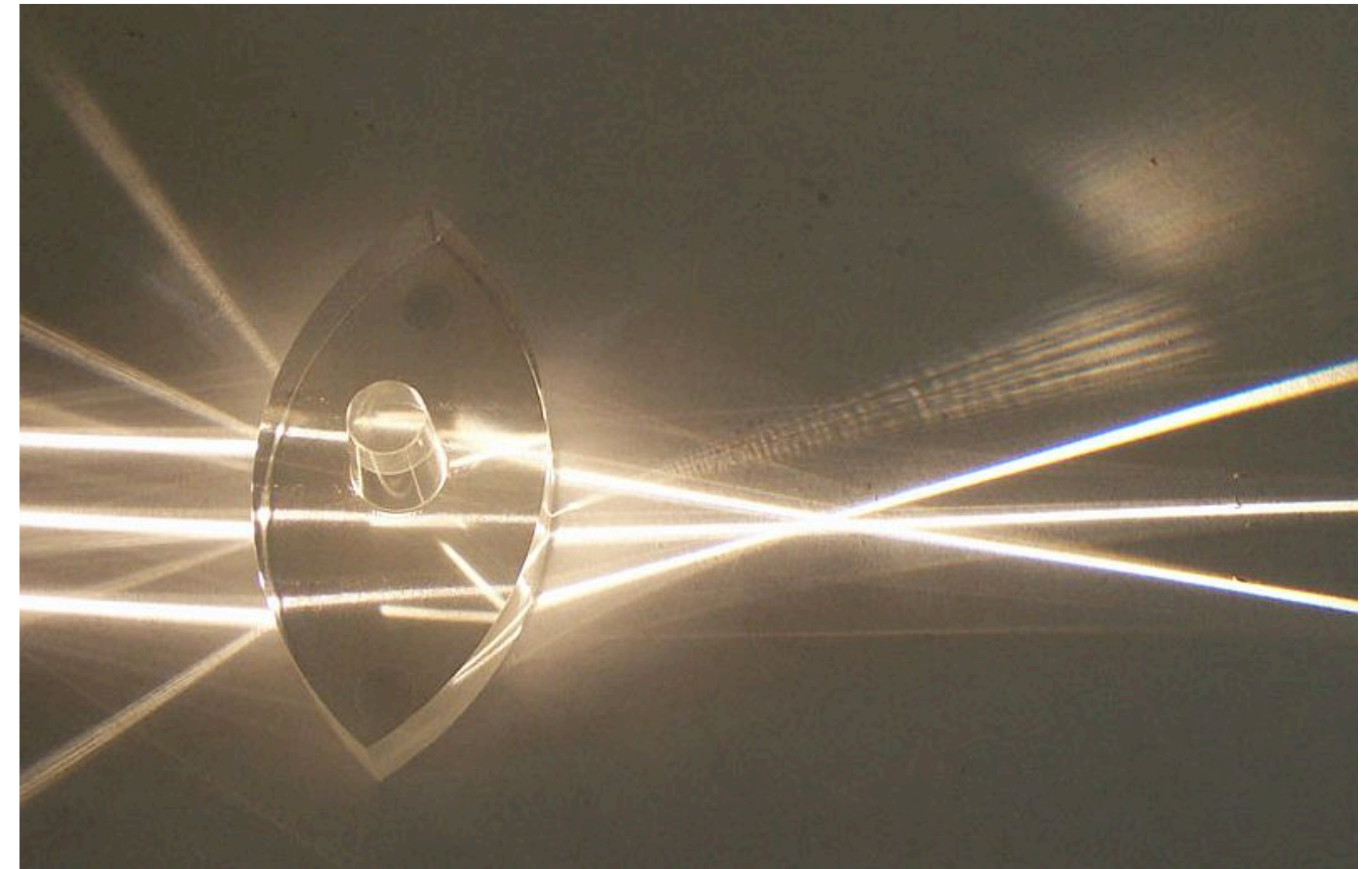

Snell's Law

$$n_1 \sin \theta_1 = n_2 \sin \theta_2$$

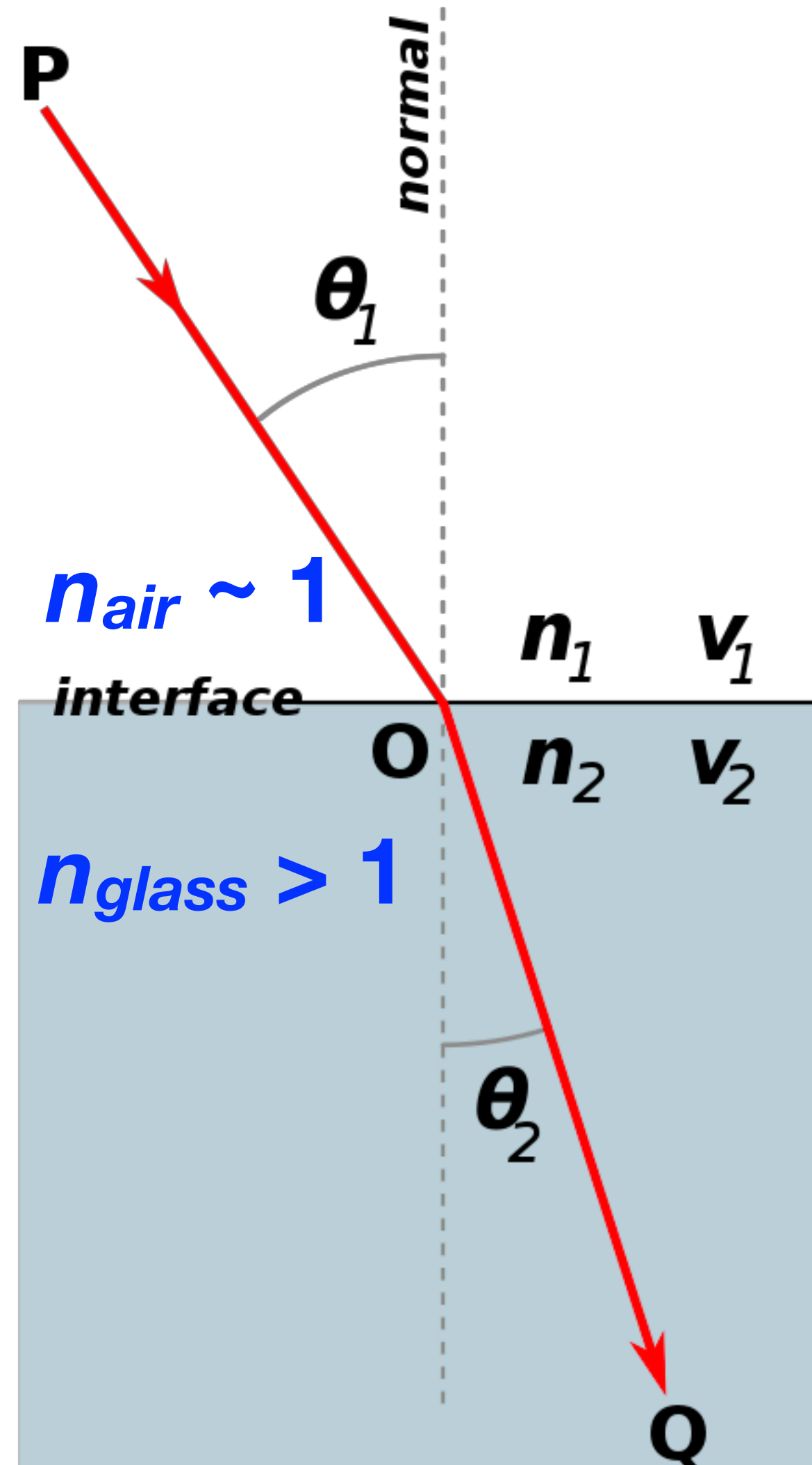

"Snel has his name mis-spelled for a couple hundred years now."

Snell's Law in Action

First Interface

Second Interface

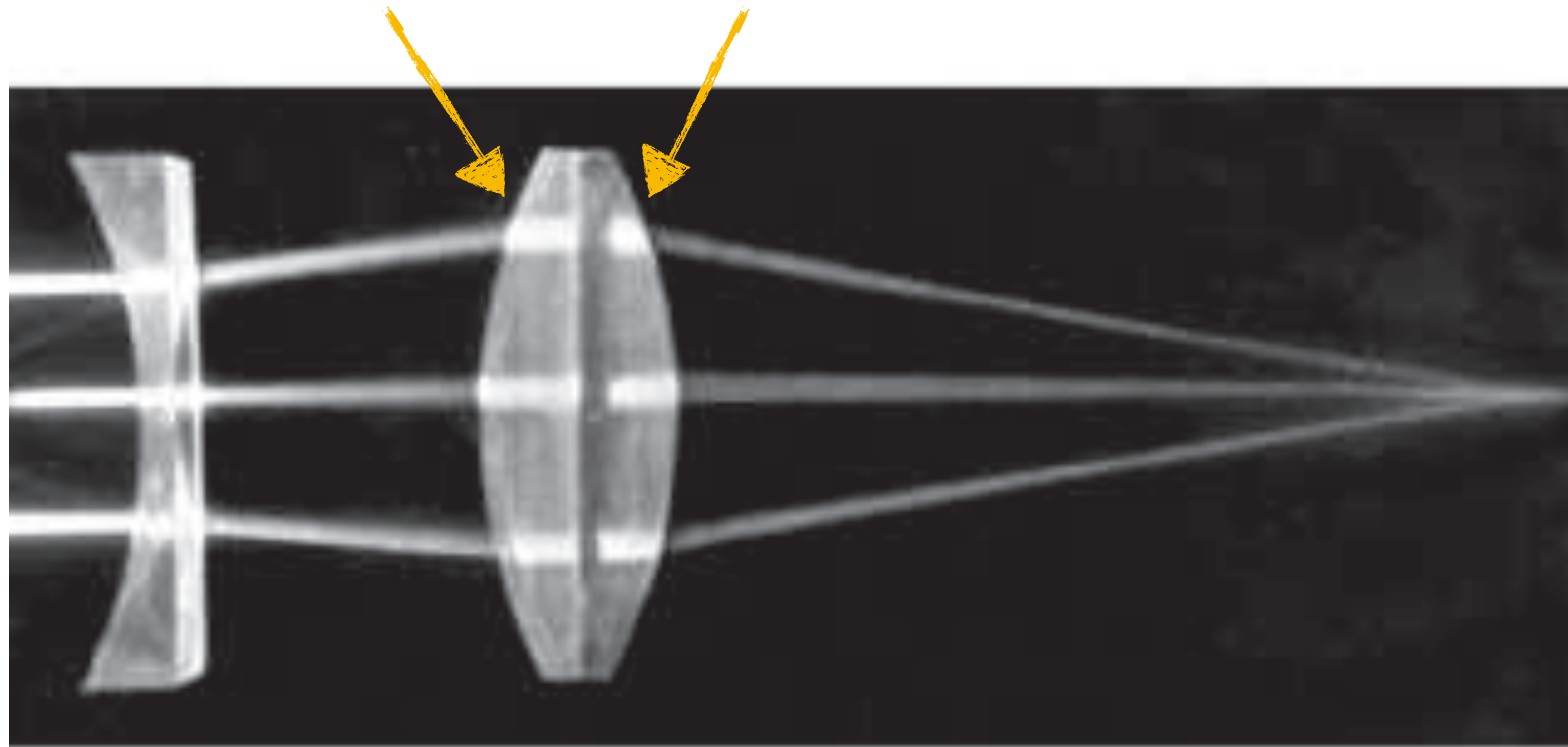

Waveguide

When light goes from glass to air and when θ_1 is large enough, there will be no refraction, and we get "total internal reflection."

~how optical fibers work.

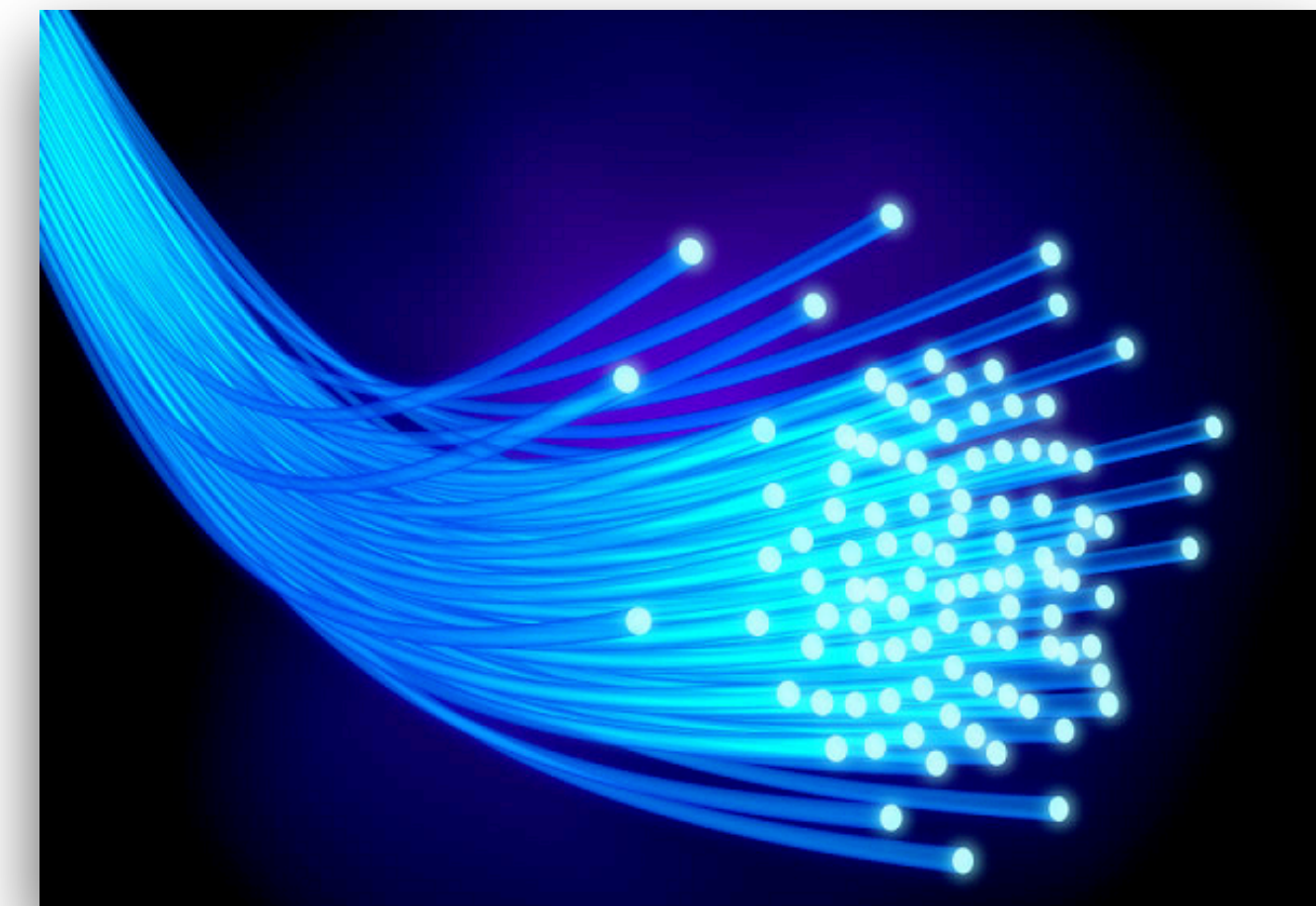
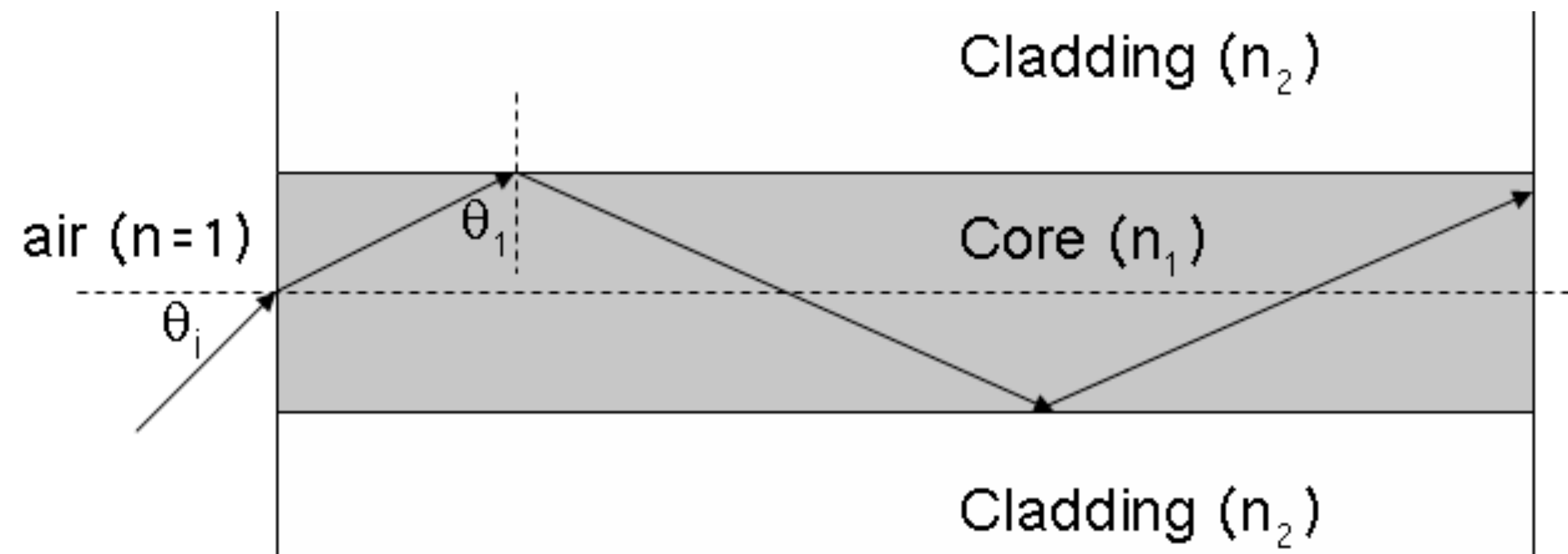

Aside: Gravitational Lens

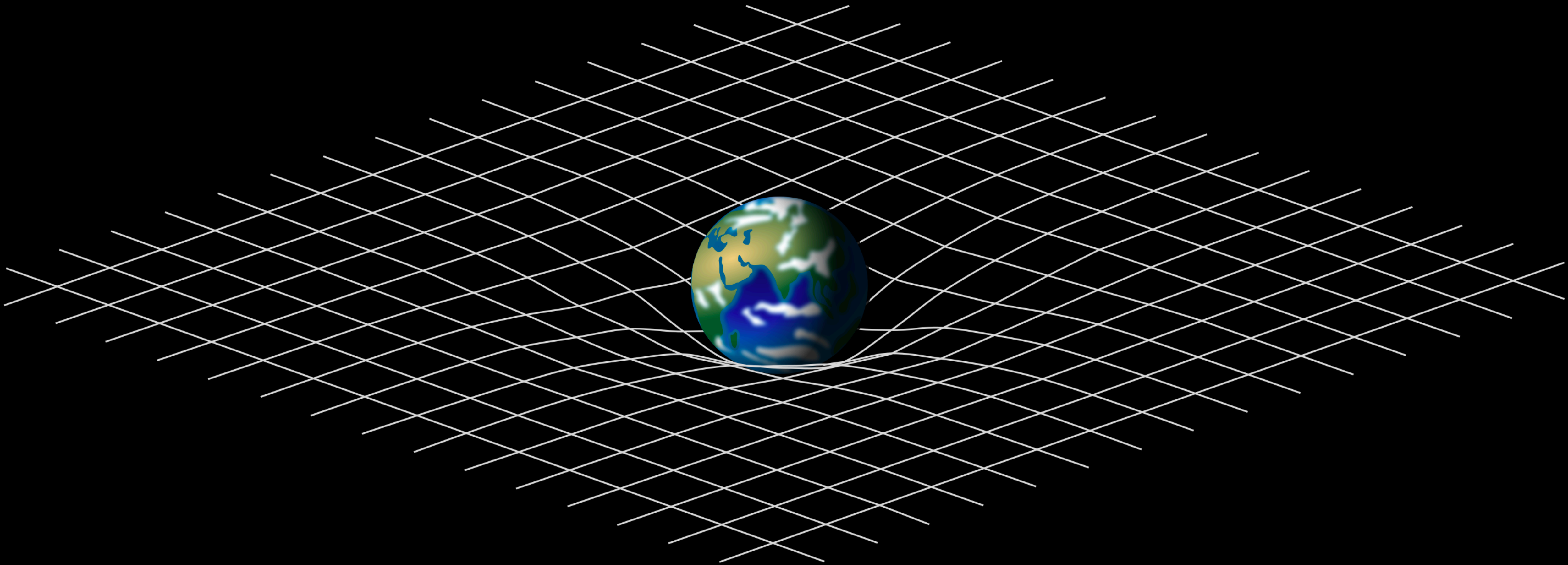

Aside: Gravitational Lens



Hubble

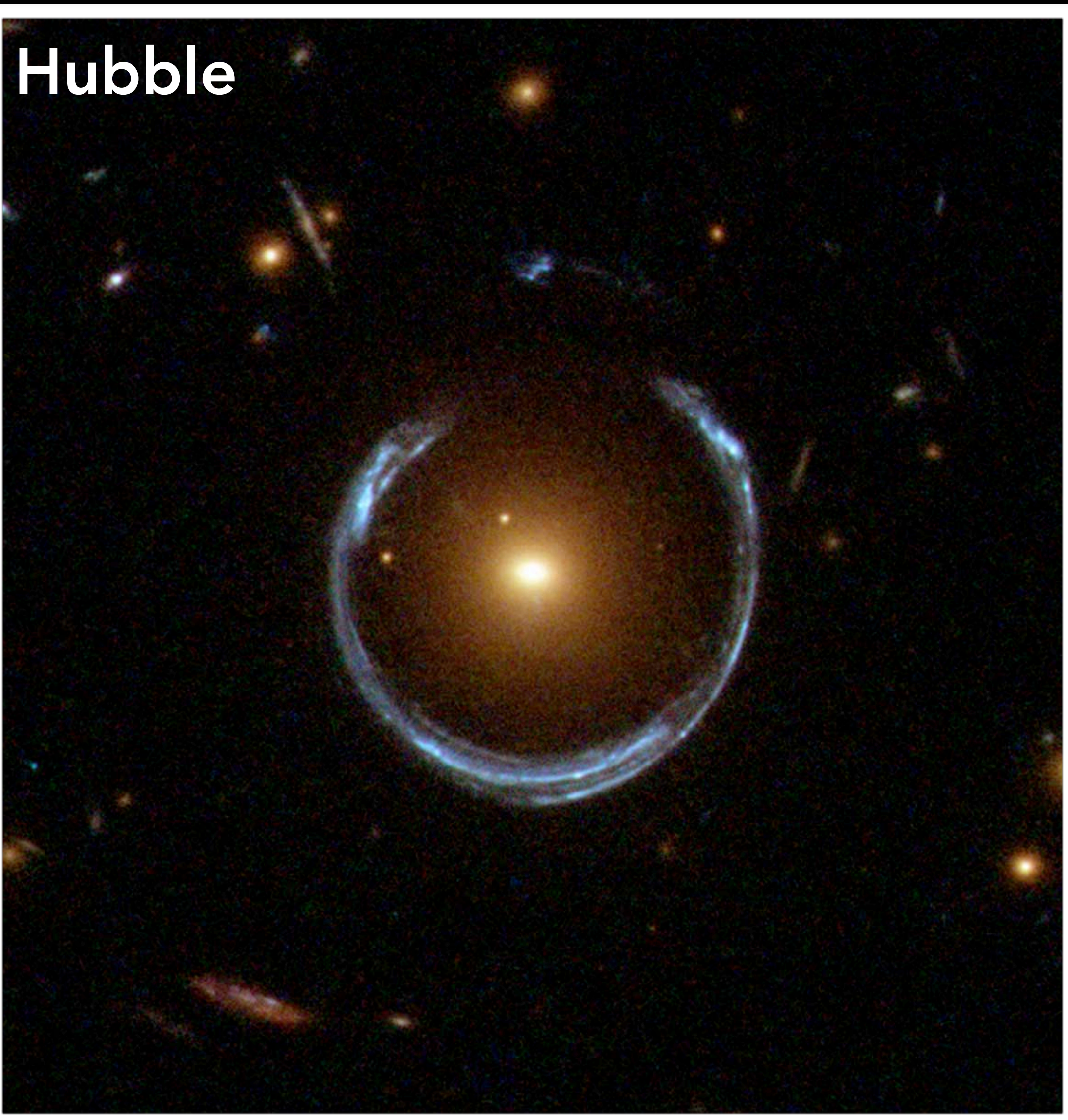

James Webber

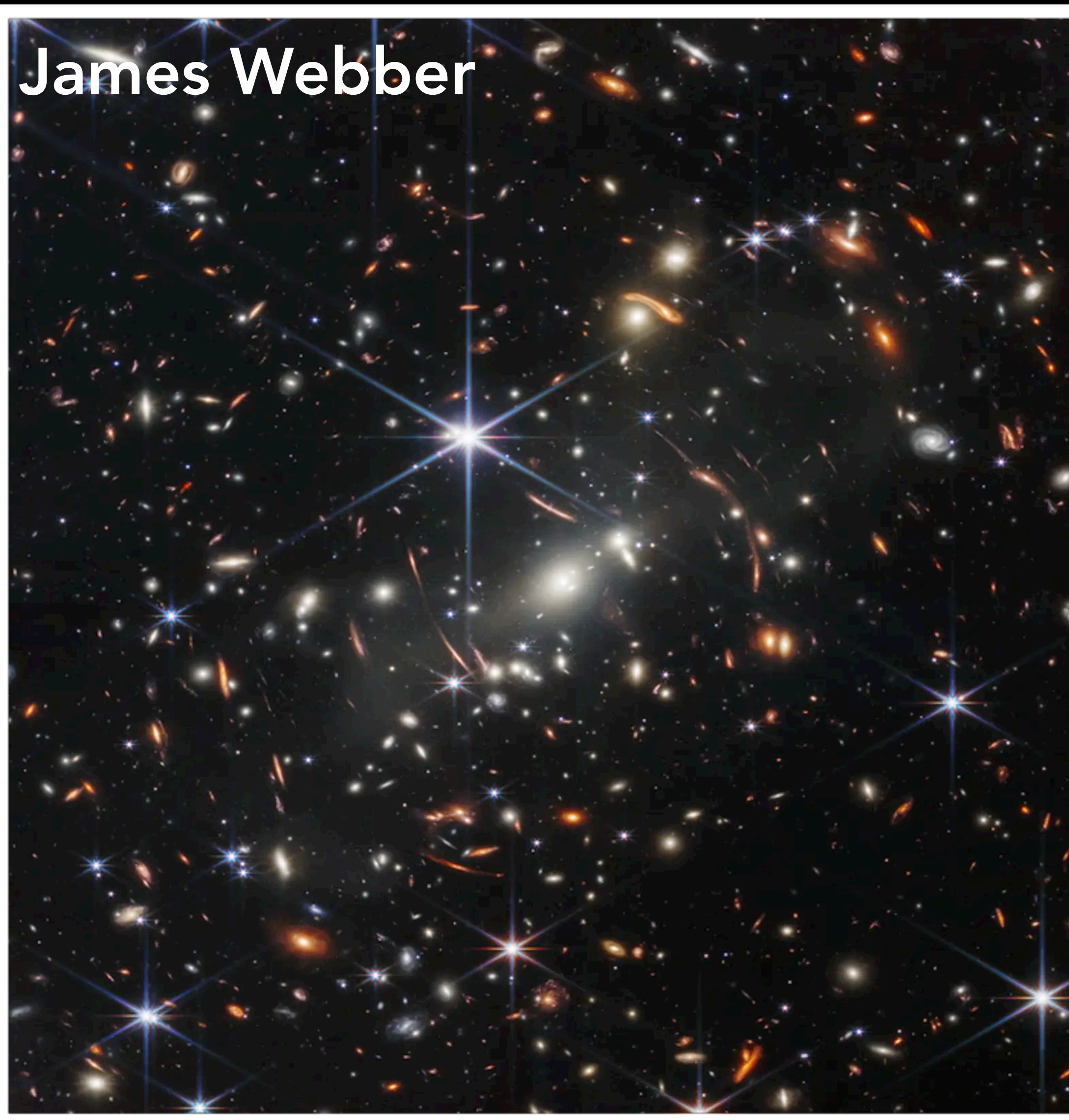

Geometrical Modeling of Lens Behaviors

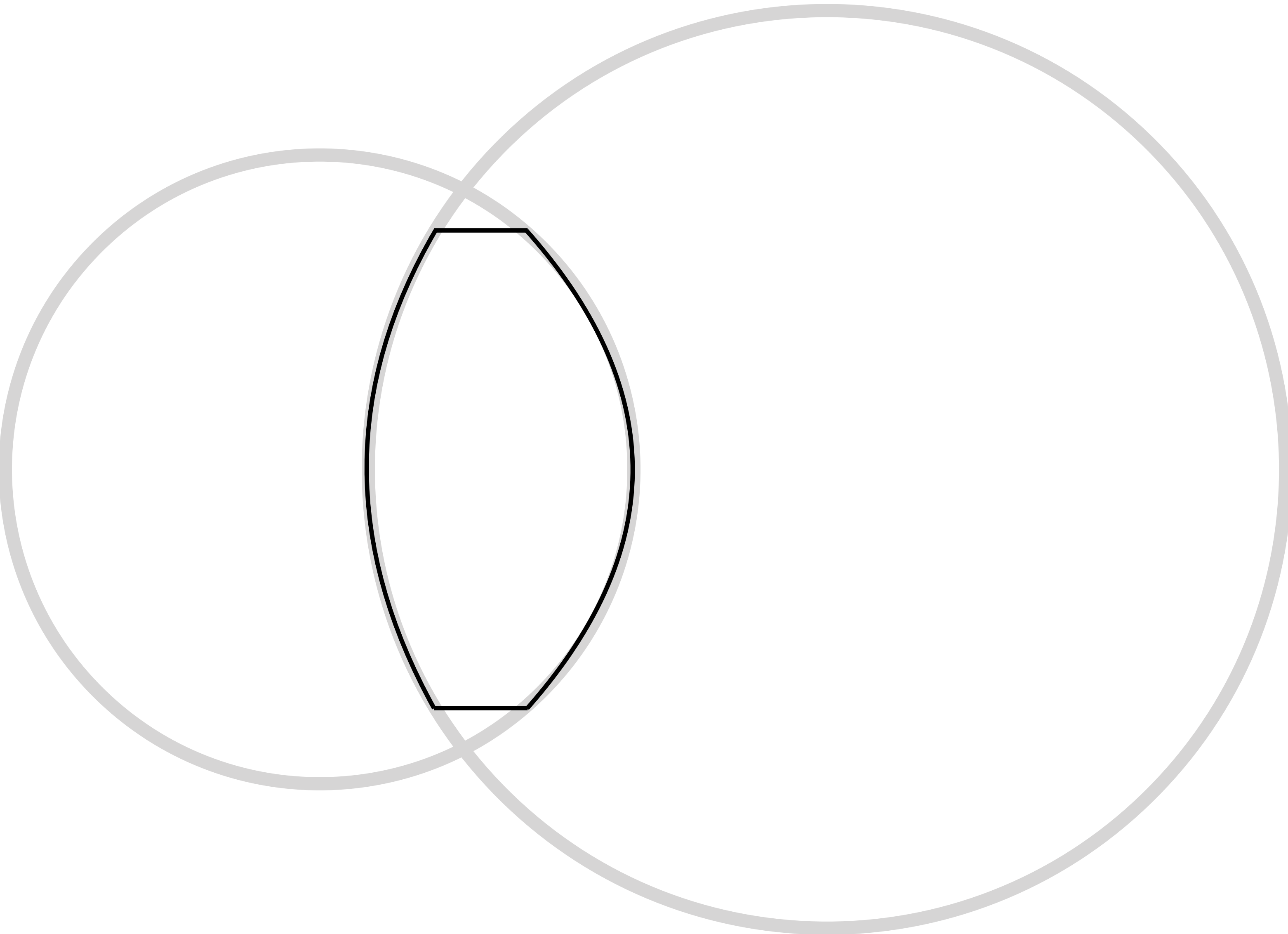

Geometrical Modeling of Lens Behaviors

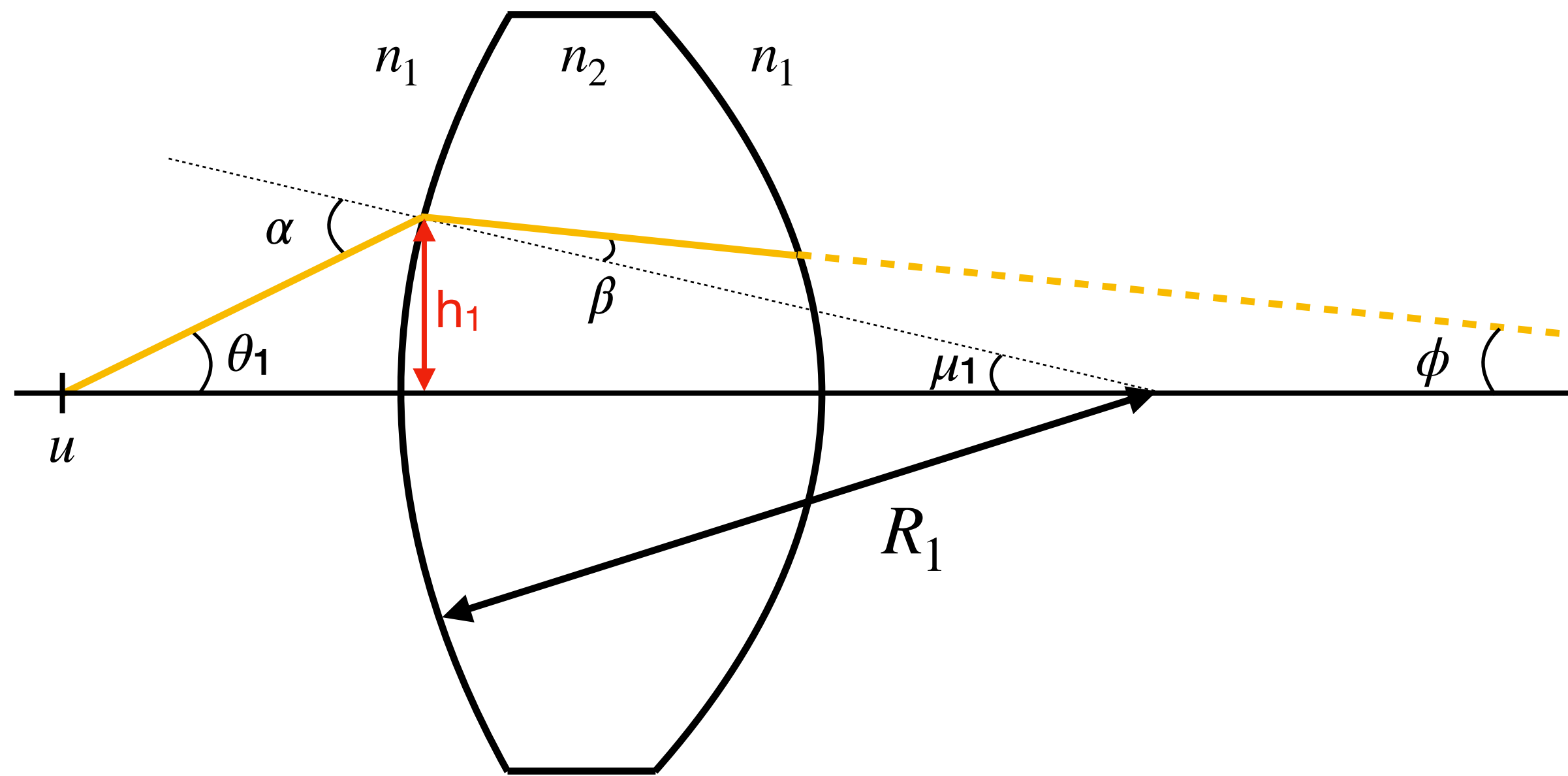

$$n_1 \sin \alpha = n_2 \sin \beta$$

$$\alpha = \theta_1 + \mu_1 \quad \beta = \mu_1 - \phi$$

$$\sin \mu_1 = \frac{h_1}{R_1} \quad \tan \theta_1 = \frac{h_1}{u}$$

Geometrical Modeling of Lens Behaviors

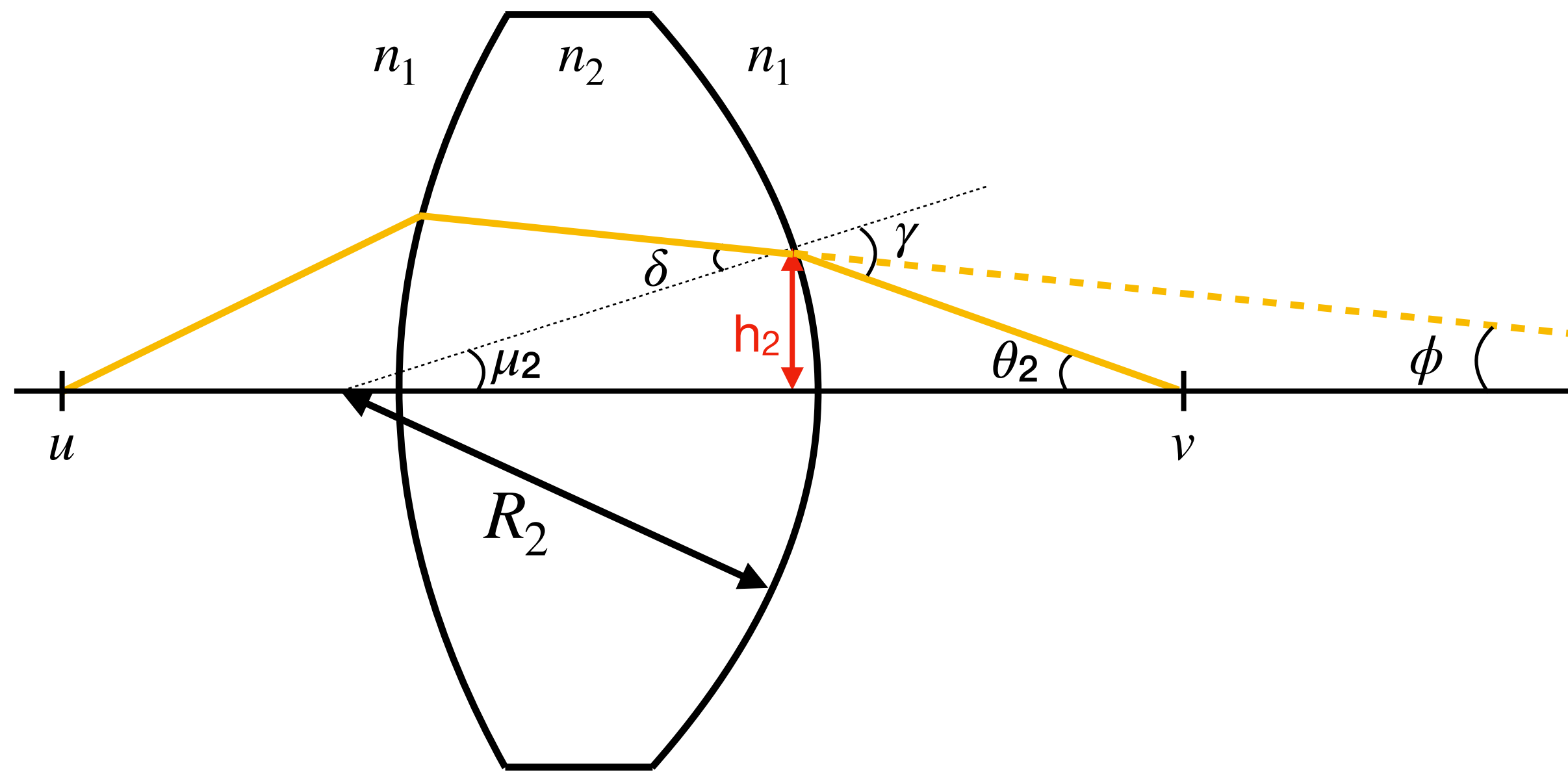

$$n_1 \sin \alpha = n_2 \sin \beta$$

$$\alpha = \theta_1 + \mu_1 \quad \beta = \mu_1 - \phi$$

$$\sin \mu_1 = \frac{h_1}{R_1} \quad \tan \theta_1 = \frac{h_1}{u}$$

$$n_2 \sin \delta = n_1 \sin \gamma$$

$$\delta = \mu_2 + \phi \quad \gamma = \mu_2 + \theta_2$$

$$\sin \mu_2 = \frac{h_2}{R_2} \quad \tan \theta_2 = \frac{h_2}{v}$$

Assumption 1: Thin Lens Assumption

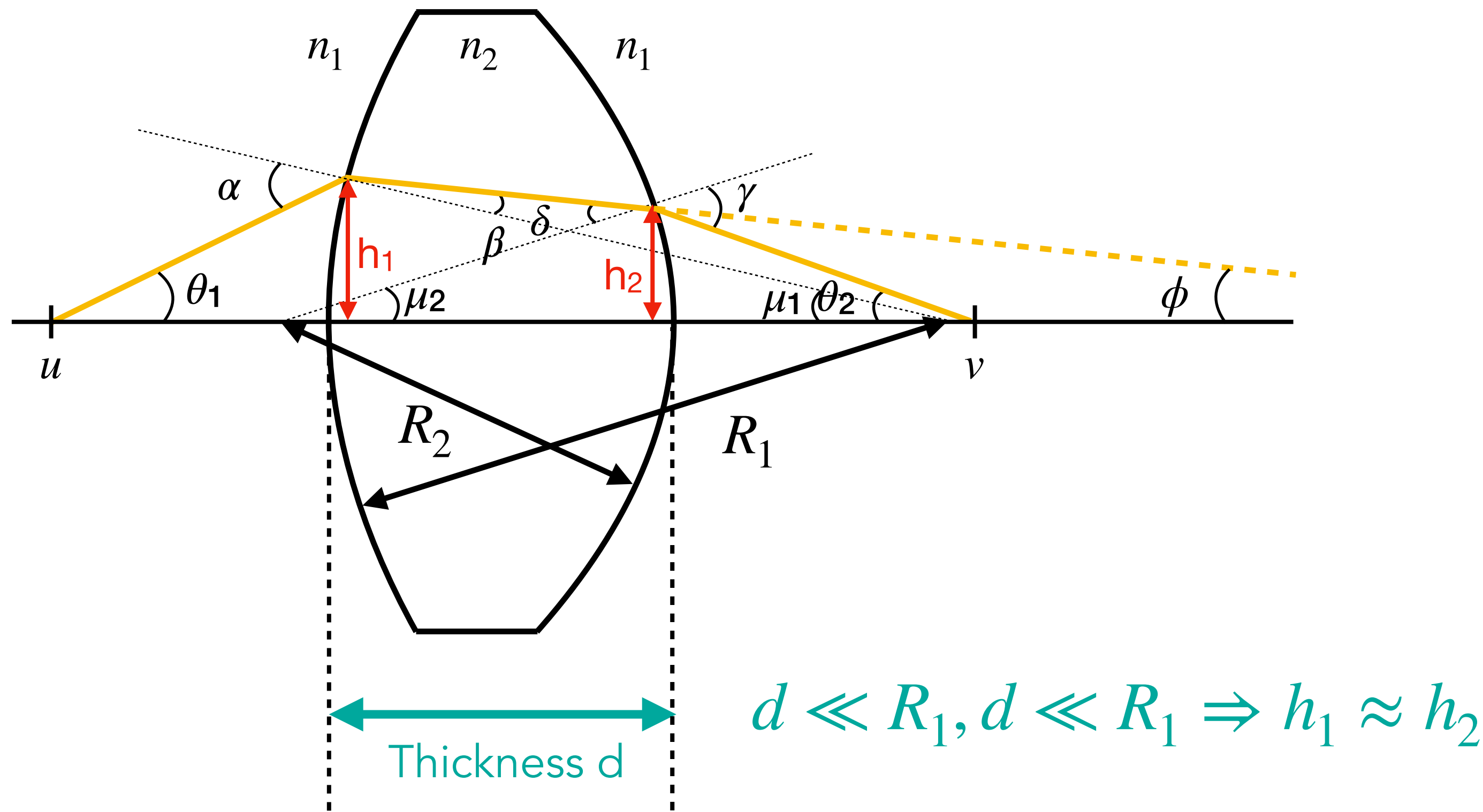

$$n_1 \sin \alpha = n_2 \sin \beta$$

$$\alpha = \theta_1 + \mu_1 \quad \beta = \mu_1 - \phi$$

$$\sin \mu_1 = \frac{h_1}{R_1} \quad \tan \theta_1 = \frac{h_1}{u}$$

$$n_2 \sin \delta = n_1 \sin \gamma$$

$$\delta = \mu_2 + \phi \quad \gamma = \mu_2 + \theta_2$$

$$\sin \mu_2 = \frac{h_2}{R_2} \quad \tan \theta_2 = \frac{h_2}{v}$$

Assumption 2: Paraxial Assumption

Consider only rays staying close to the optical axis.

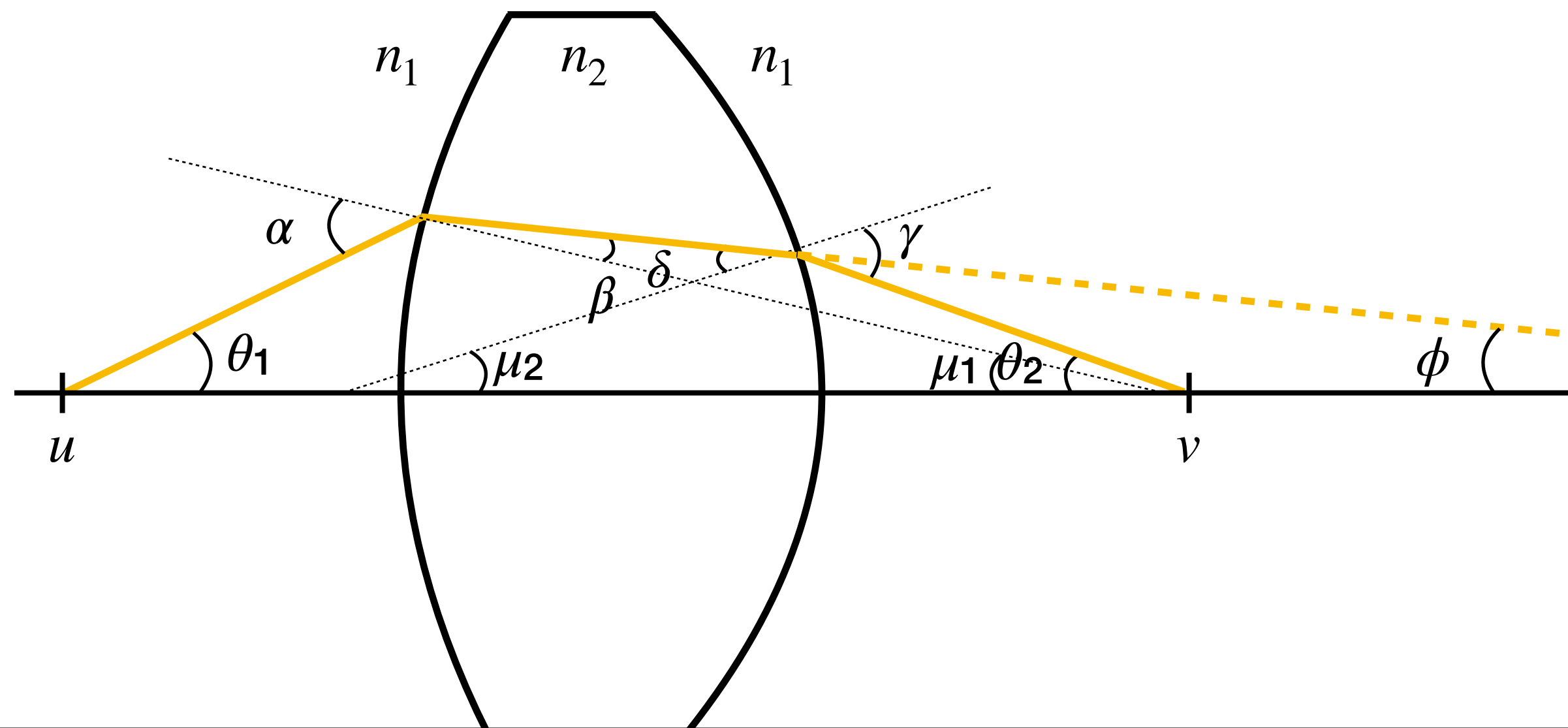

$$n_1 \sin \alpha = n_2 \sin \beta$$

$$\alpha = \theta_1 + \mu_1 \quad \beta = \mu_1 - \phi$$

$$\sin \mu_1 = \frac{h_1}{R_1} \quad \tan \theta_1 = \frac{h_1}{u}$$

$$n_2 \sin \delta = n_1 \sin \gamma$$

$$\delta = \mu_2 + \phi \quad \gamma = \mu_2 + \theta_2$$

$$\sin \mu_2 = \frac{h_2}{R_2} \quad \tan \theta_2 = \frac{h_2}{v}$$

So $\theta_1, \theta_2, \alpha, \beta, \gamma, \delta, \phi, \mu_1, \mu_2$ are all small angles.

For a small angle α : $\sin(\alpha) \sim \tan(\alpha) \sim \alpha$; $\cos(\alpha) \sim 1$.

Lens Maker's Equation

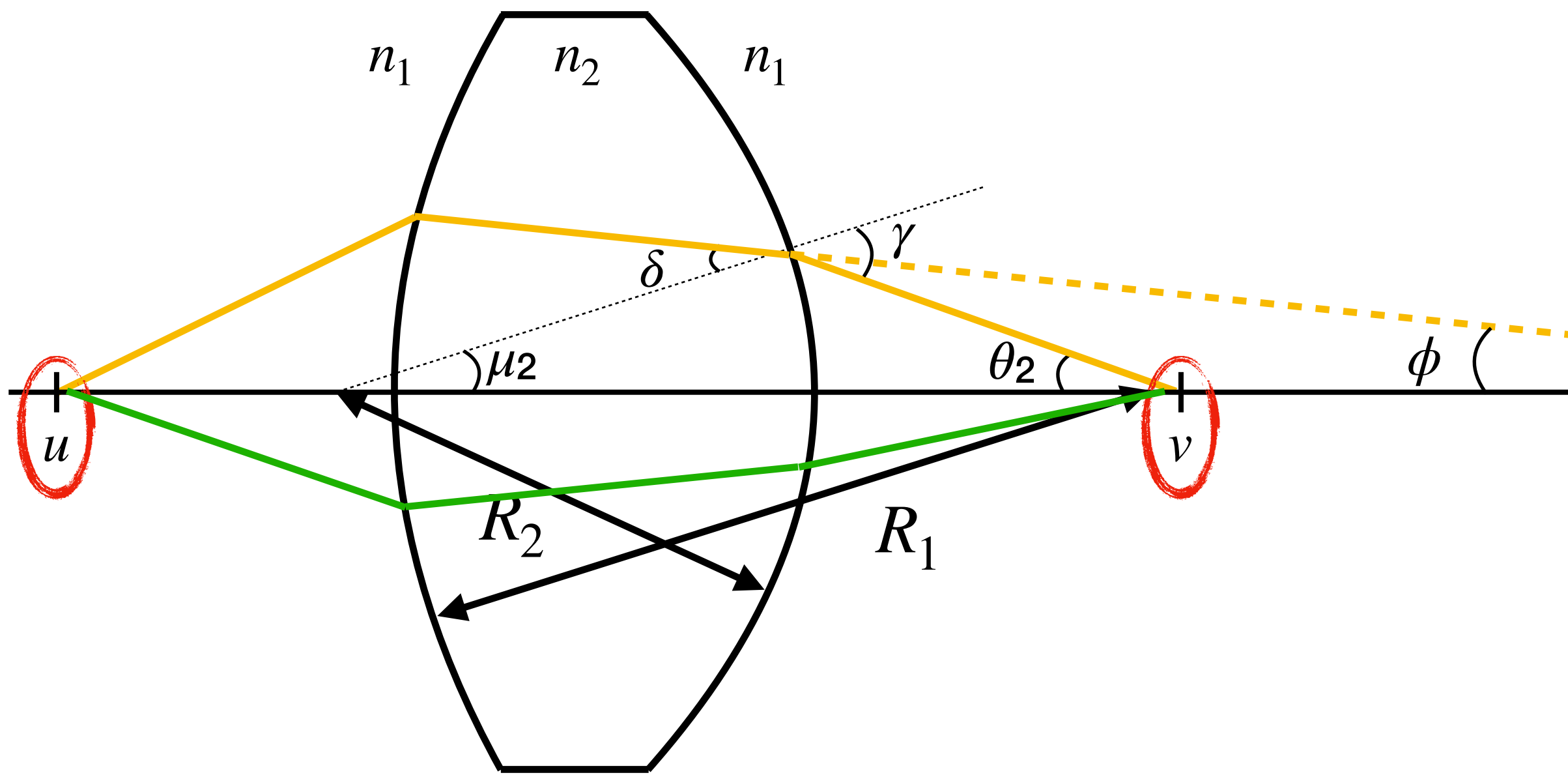

$$\frac{n_2 - n_1}{n_1} \left(\frac{1}{R_1} + \frac{1}{R_2} \right) = \left(\frac{1}{u} + \frac{1}{v} \right)$$

Observe that v depends only on u regardless of the path the ray takes (for a given camera)

- So all rays from an on-axis point focus at the same point
- In reality, only paraxial rays follow this (more later)

Lens Maker's Equation

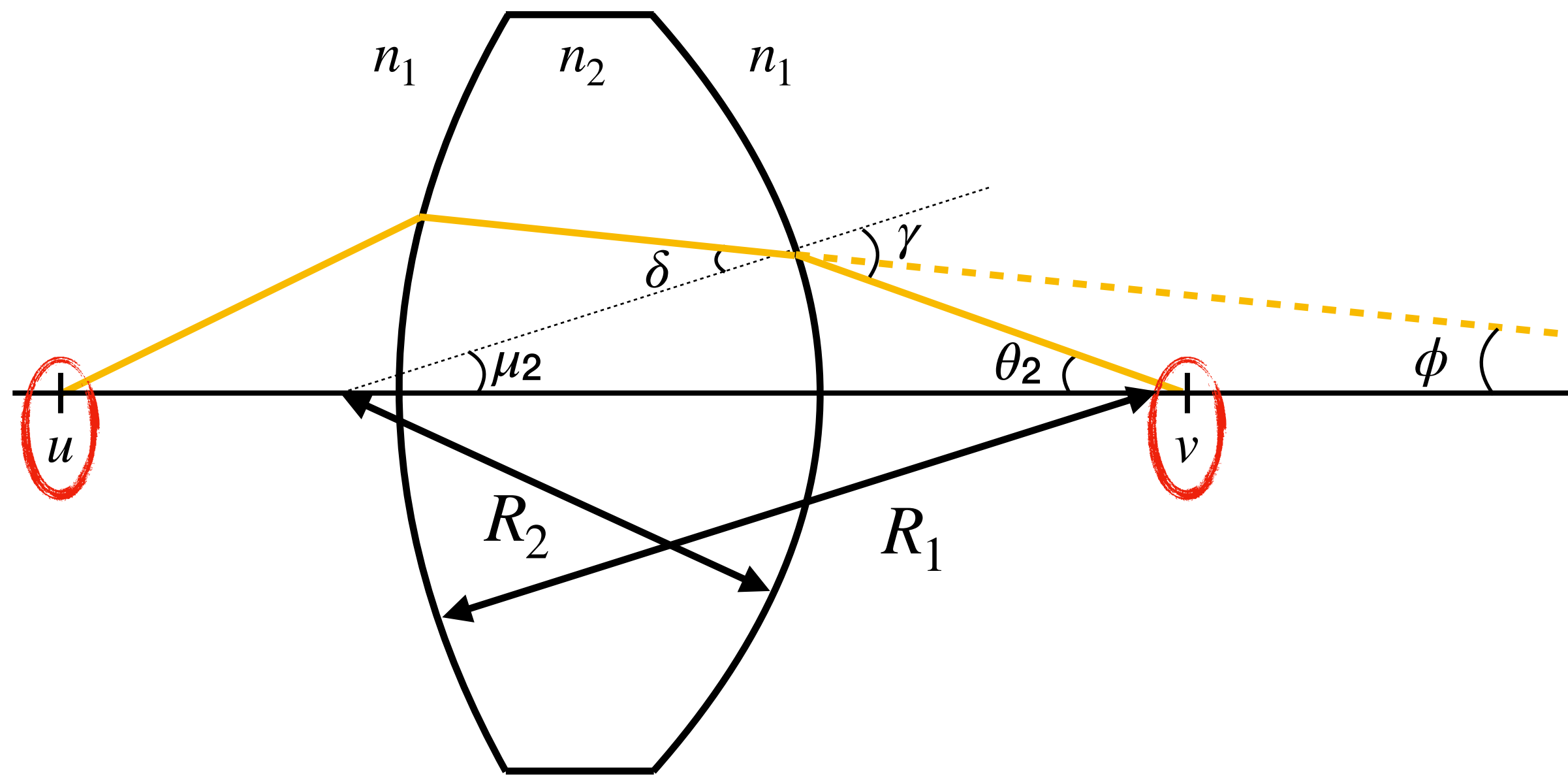

$$\frac{n_2 - n_1}{n_1} \left(\frac{1}{R_1} + \frac{1}{R_2} \right) = \left(\frac{1}{u} + \frac{1}{v} \right)$$

↓ $u \rightarrow \infty$

Gauss' Lens Equation

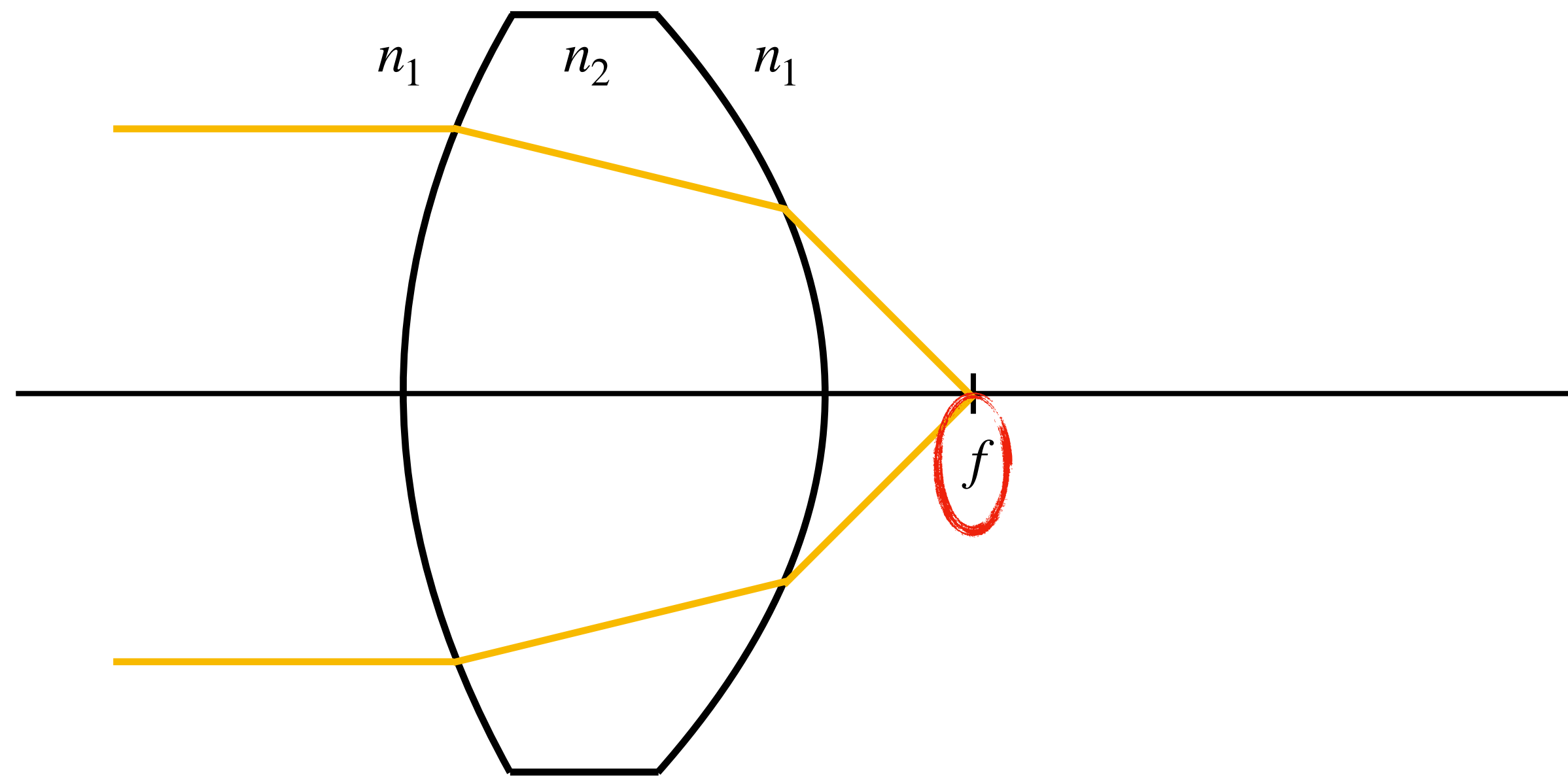

That is, incident rays parallel to optical axis converge at the same point

$$\frac{n_2 - n_1}{n_1} \left(\frac{1}{R_1} + \frac{1}{R_2} \right) = \left(\frac{1}{u} + \frac{1}{v} \right)$$

↓ $u \rightarrow \infty$

$$\frac{1}{v} = \frac{n_2 - n_1}{n_1} \left(\frac{1}{R_1} + \frac{1}{R_2} \right) = \frac{1}{f}$$

Where parallel rays converge is **defined** as the focal point

Gauss' Lens Equation

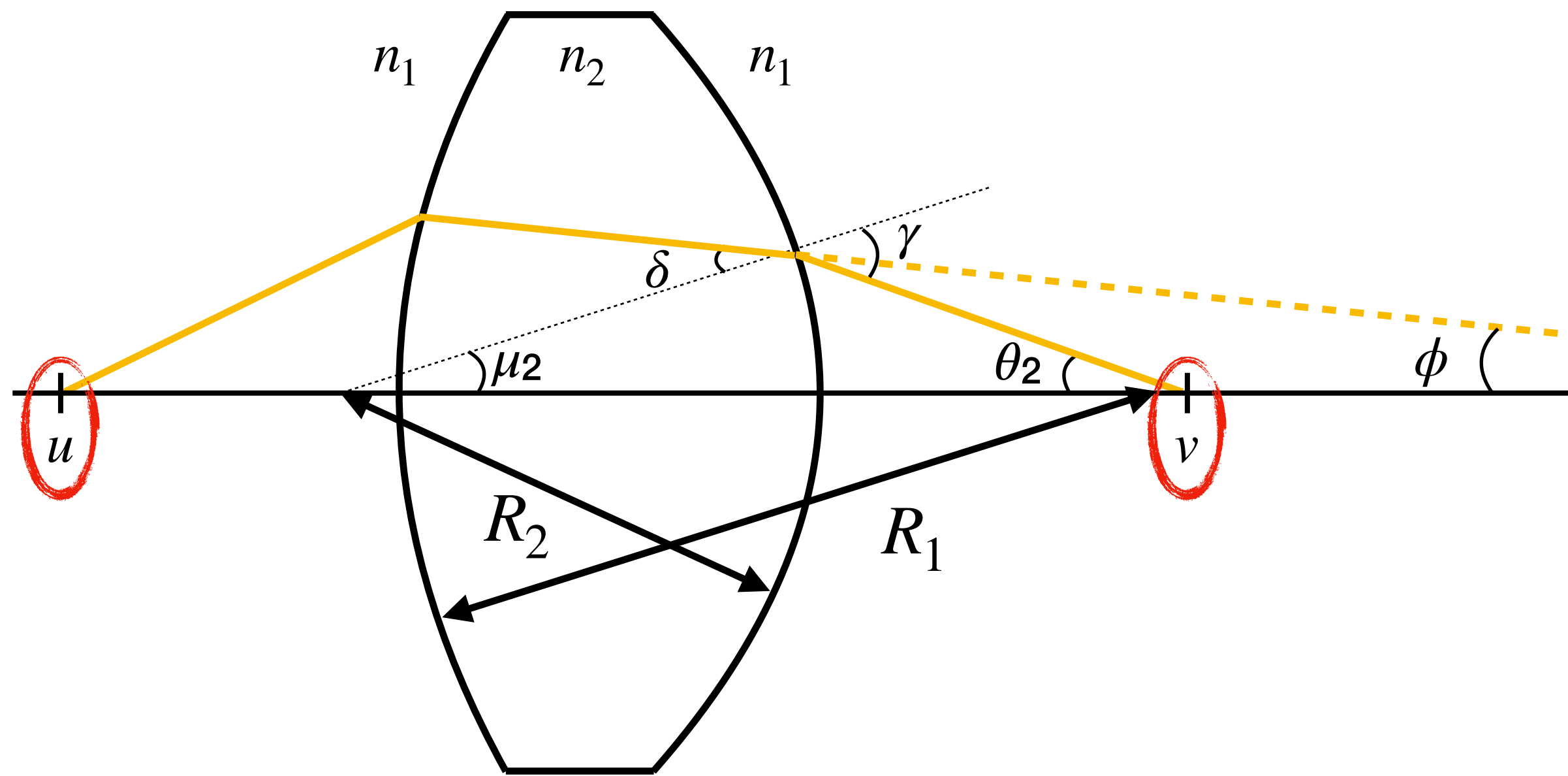

$$\frac{n_2 - n_1}{n_1} \left(\frac{1}{R_1} + \frac{1}{R_2} \right) = \left(\frac{1}{u} + \frac{1}{v} \right)$$

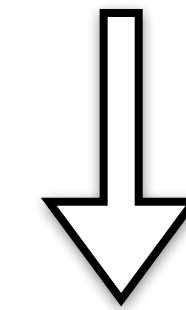

$$\frac{1}{u} + \frac{1}{v} = \frac{1}{f}$$

Simple "Rules" for Ideal Lens

Under thin lens and paraxial ray approximations:

- Rays parallel to the optical axis always pass through the focal point on the other side.
- Rays passing through the focal point will be parallel on the other side.
- Rays passing through the optical center won't change direction if the lens is symmetric.

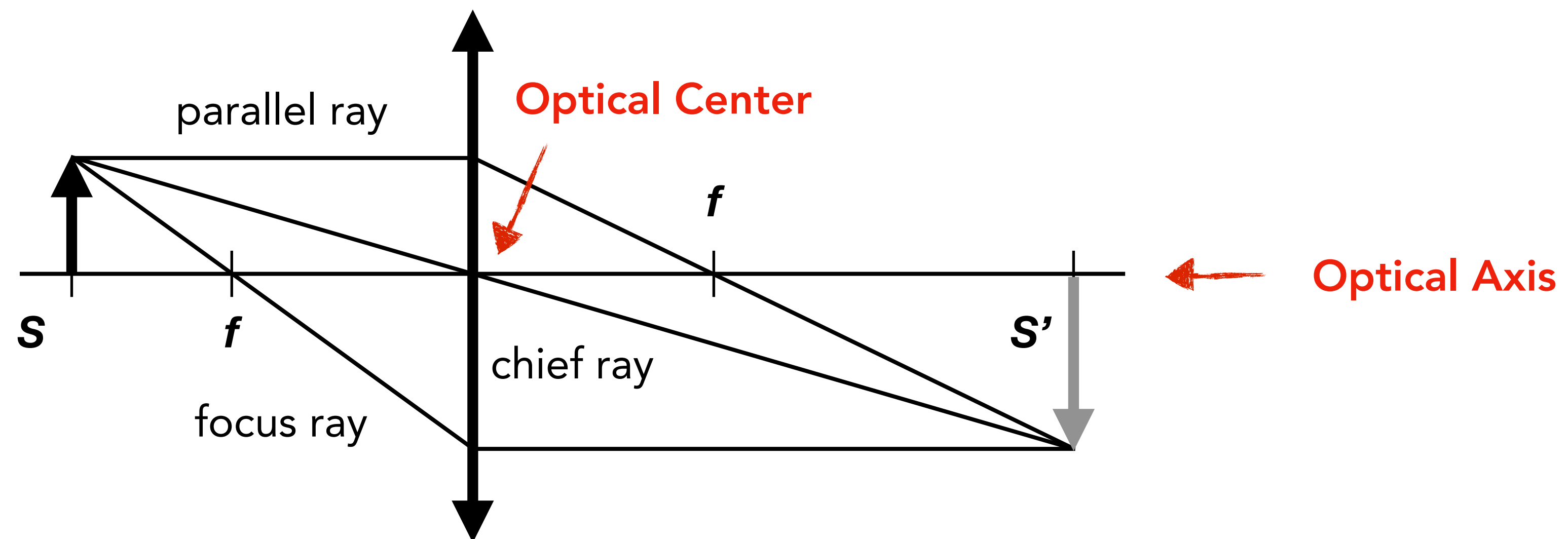

Ideal Lens

Move the sensor plane to focus on scene points at different distances.

- This is how camera auto-focus works (later)
- Or equivalently move the lens

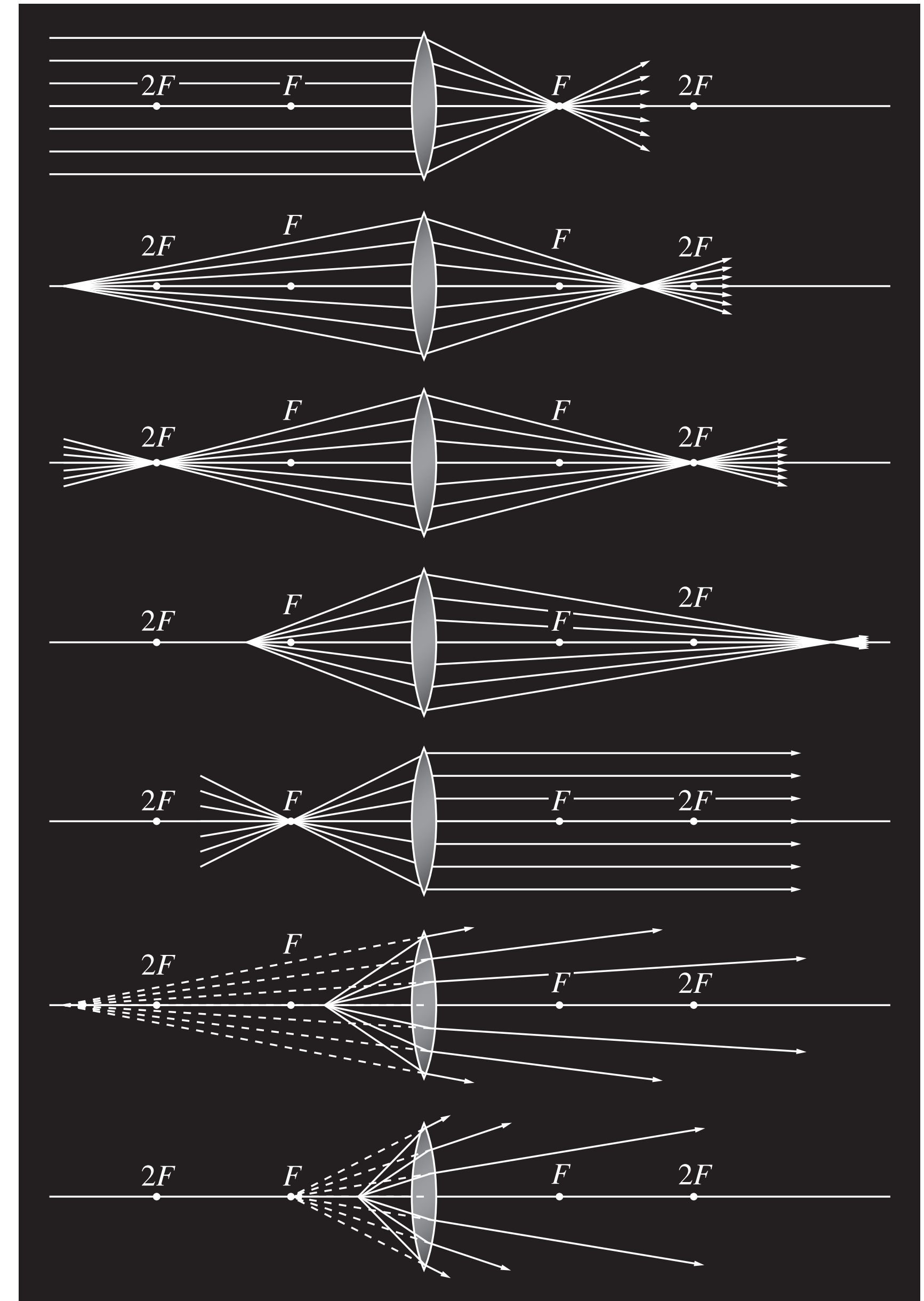

Ideal Lens

Move the sensor plane to focus on scene points at different distances.

- This is how camera auto-focus works (later)
- Or equivalently move the lens

The greater the curvature, the shorter the focal length and the more "optical power".

- Need higher optical power to focus on closer objects.

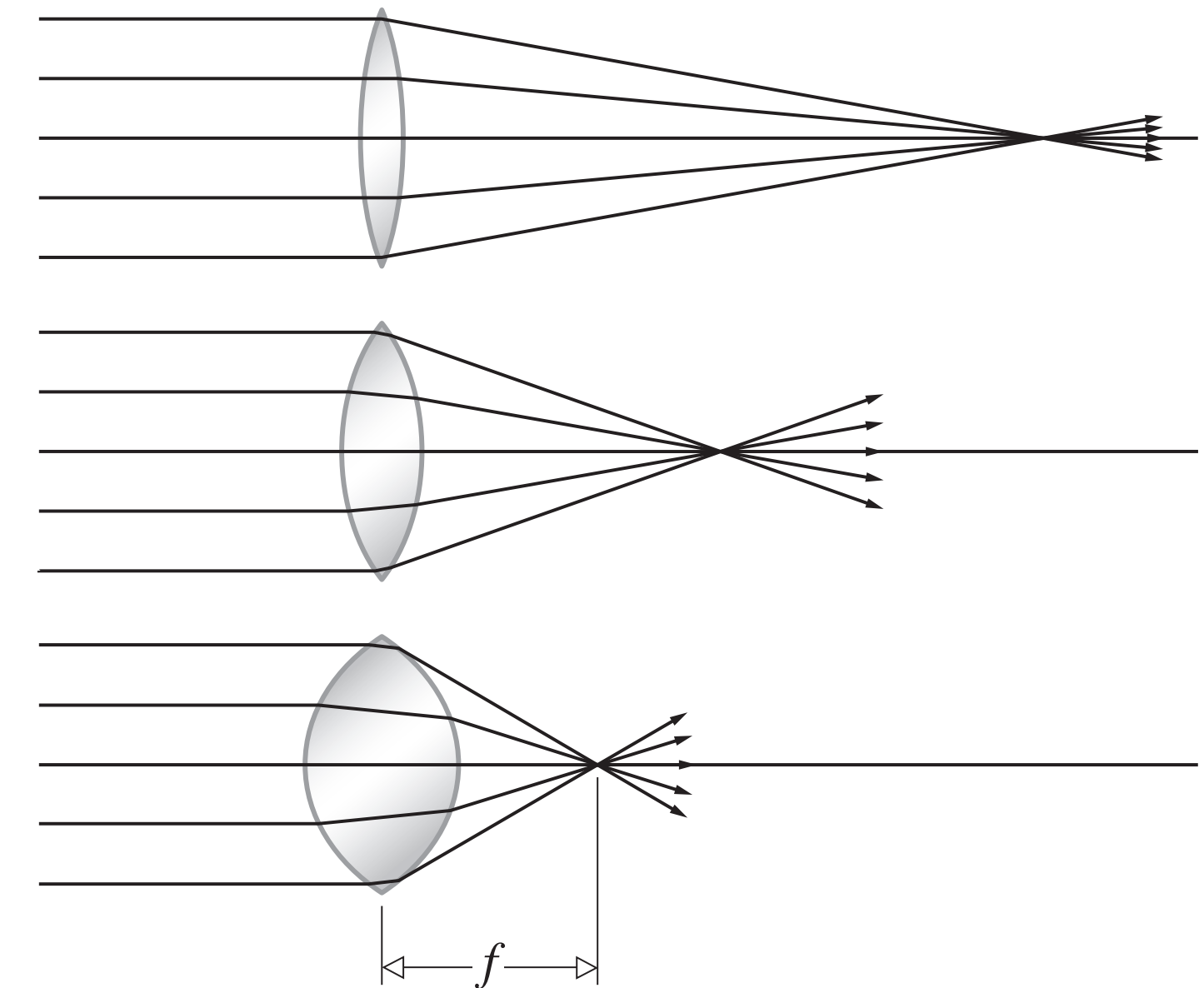

Optics in Human Eyes

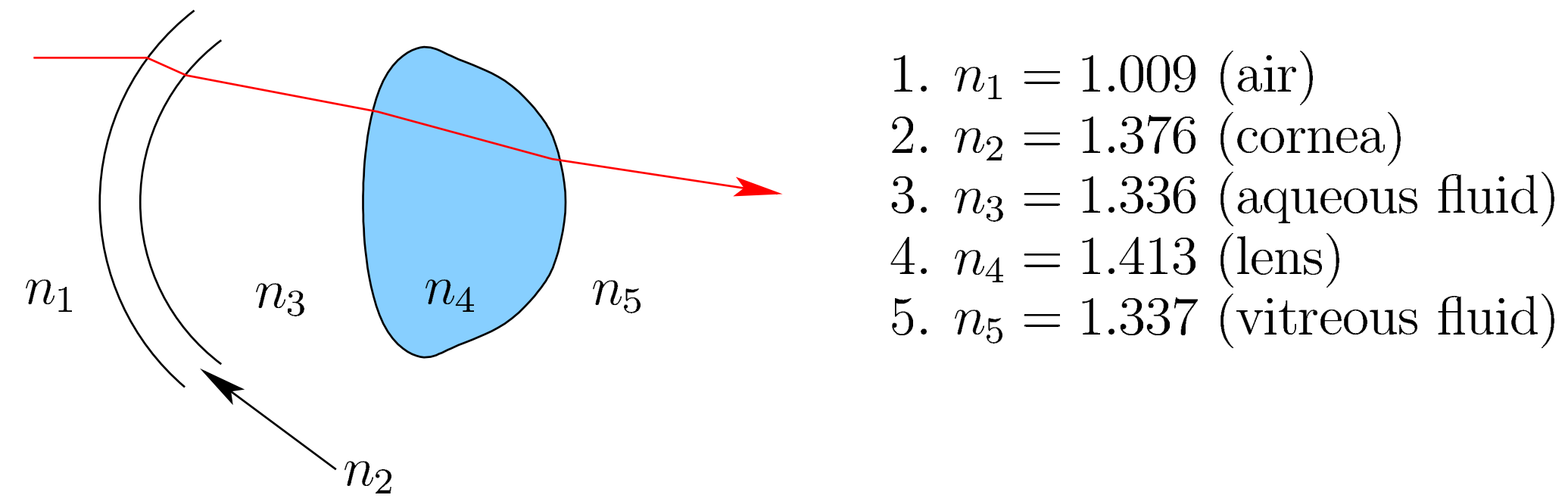
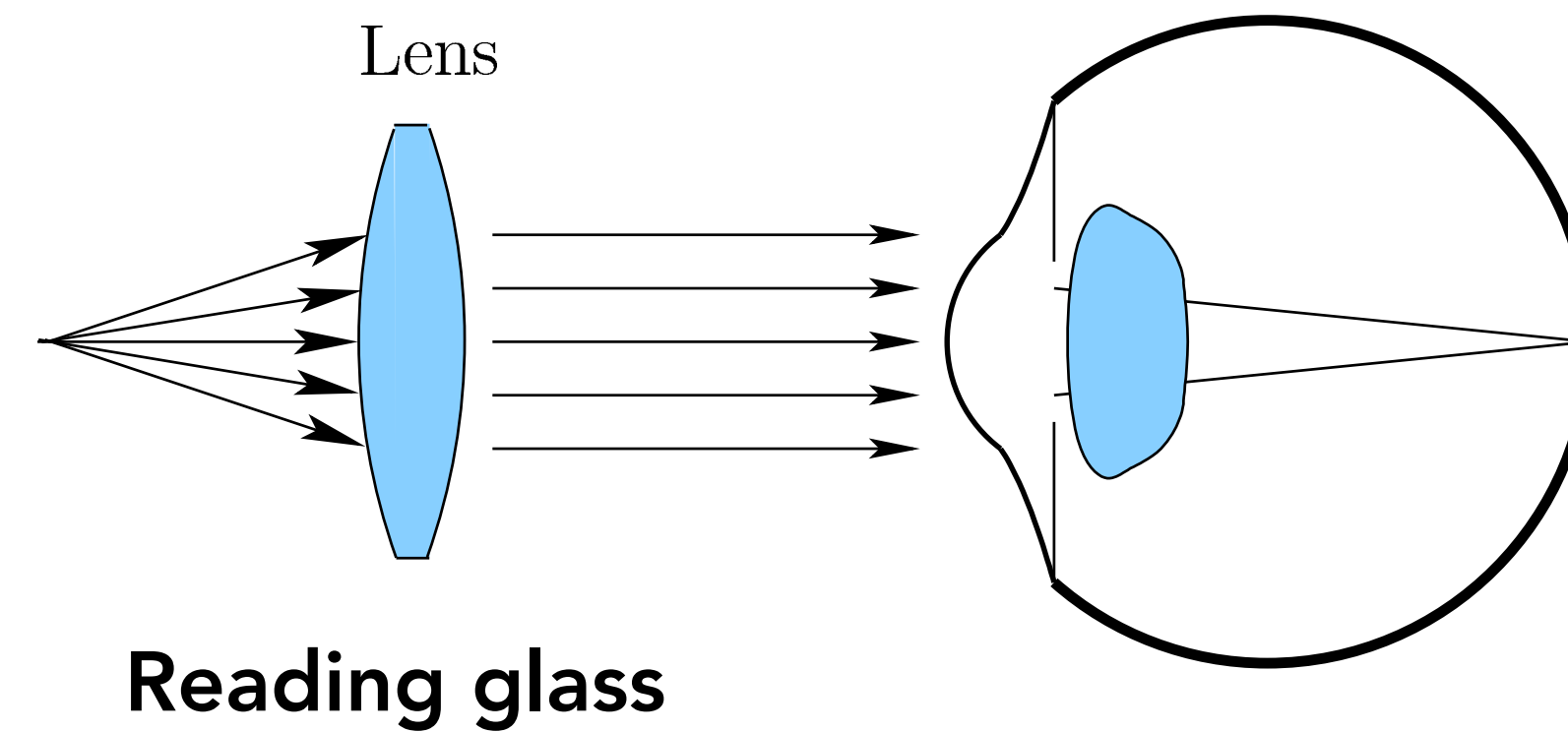
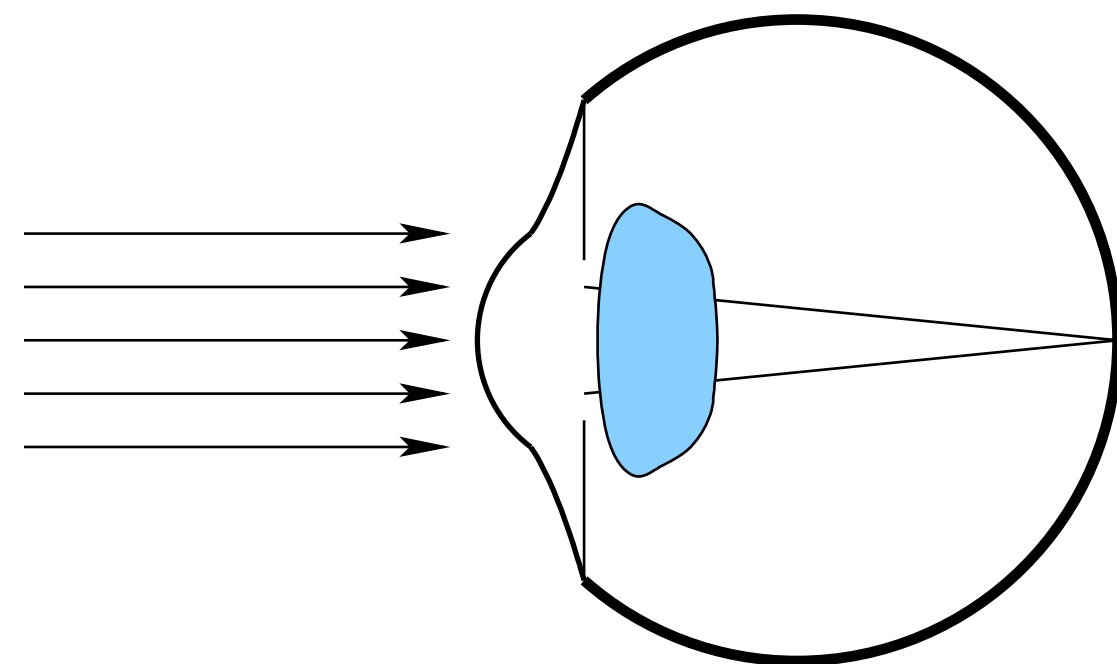
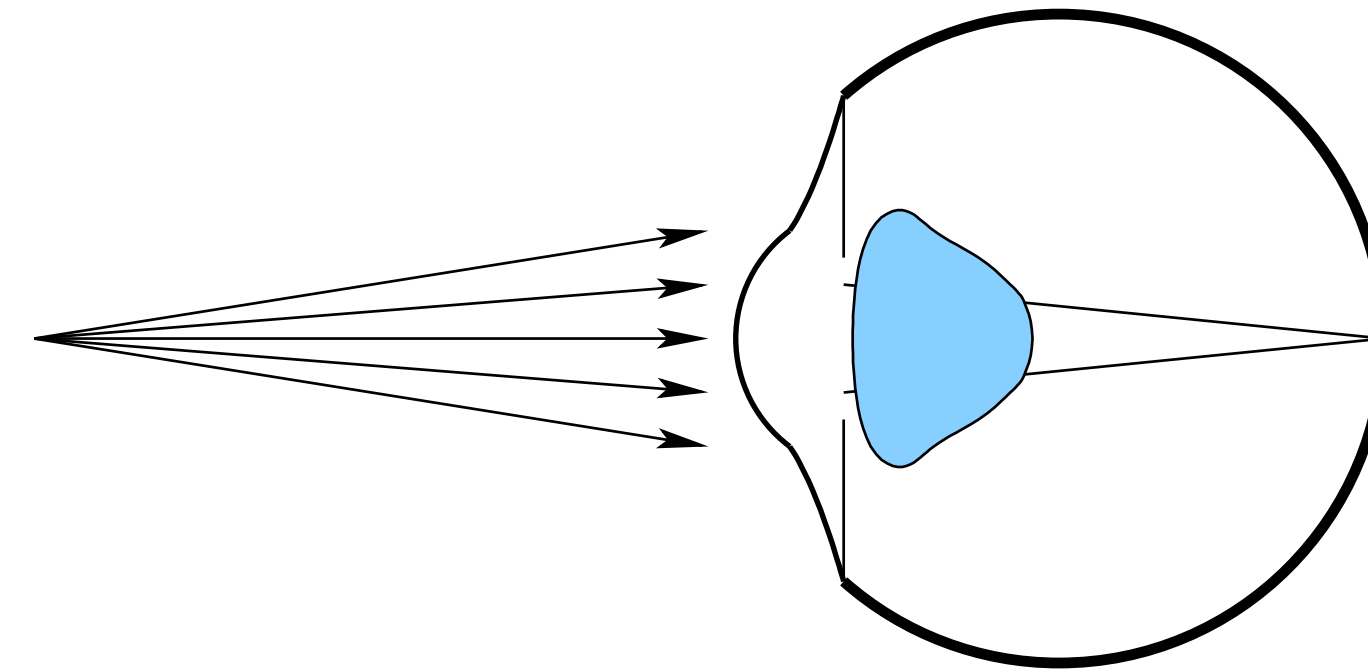

Figure 4.25: A ray of light travels through five media before hitting the retina. The indices of refraction are indicated. Considering Snell's law, the greatest bending occurs due to the transition from air to the cornea. Note that once the ray enters the eye, it passes through only liquid or solid materials.

Eye lenses "accommodate" to focus on objects of different distances



When Object is Closer Than f

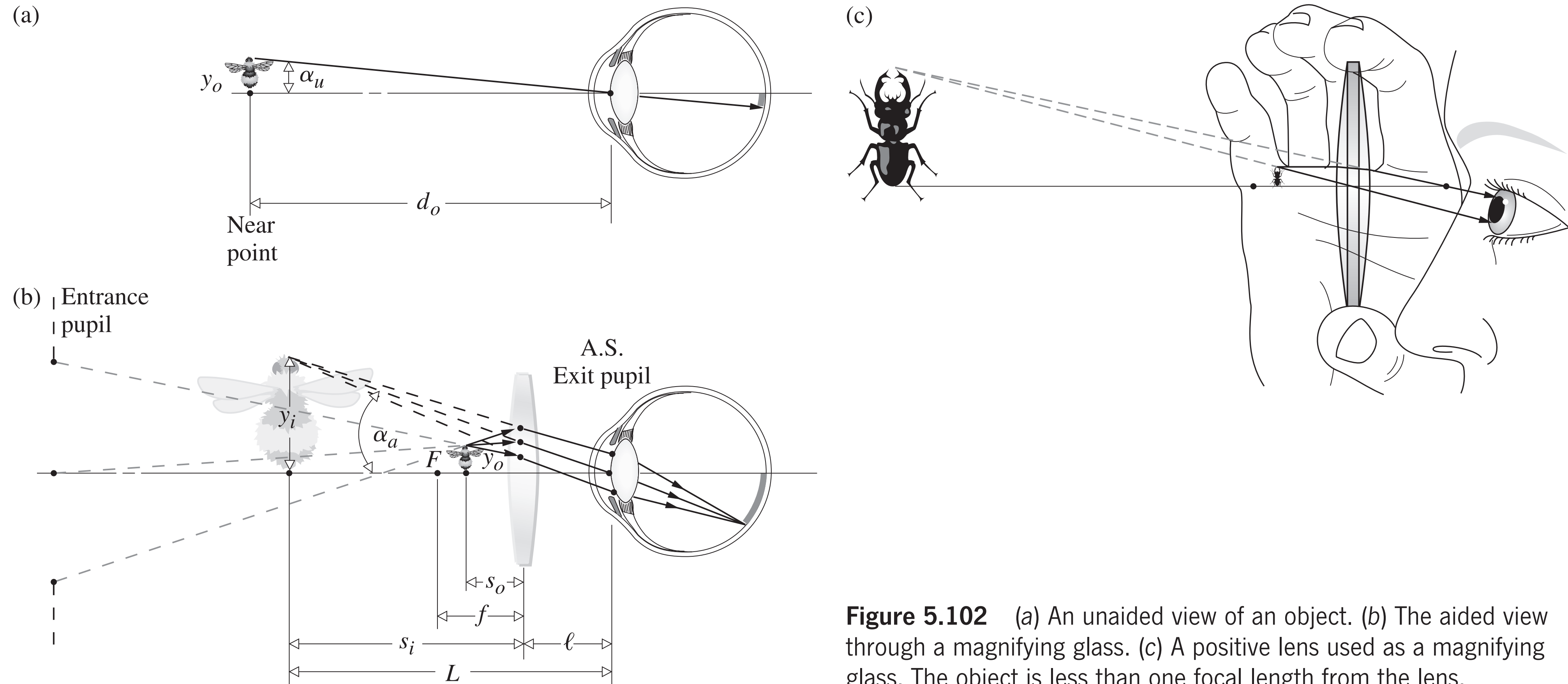
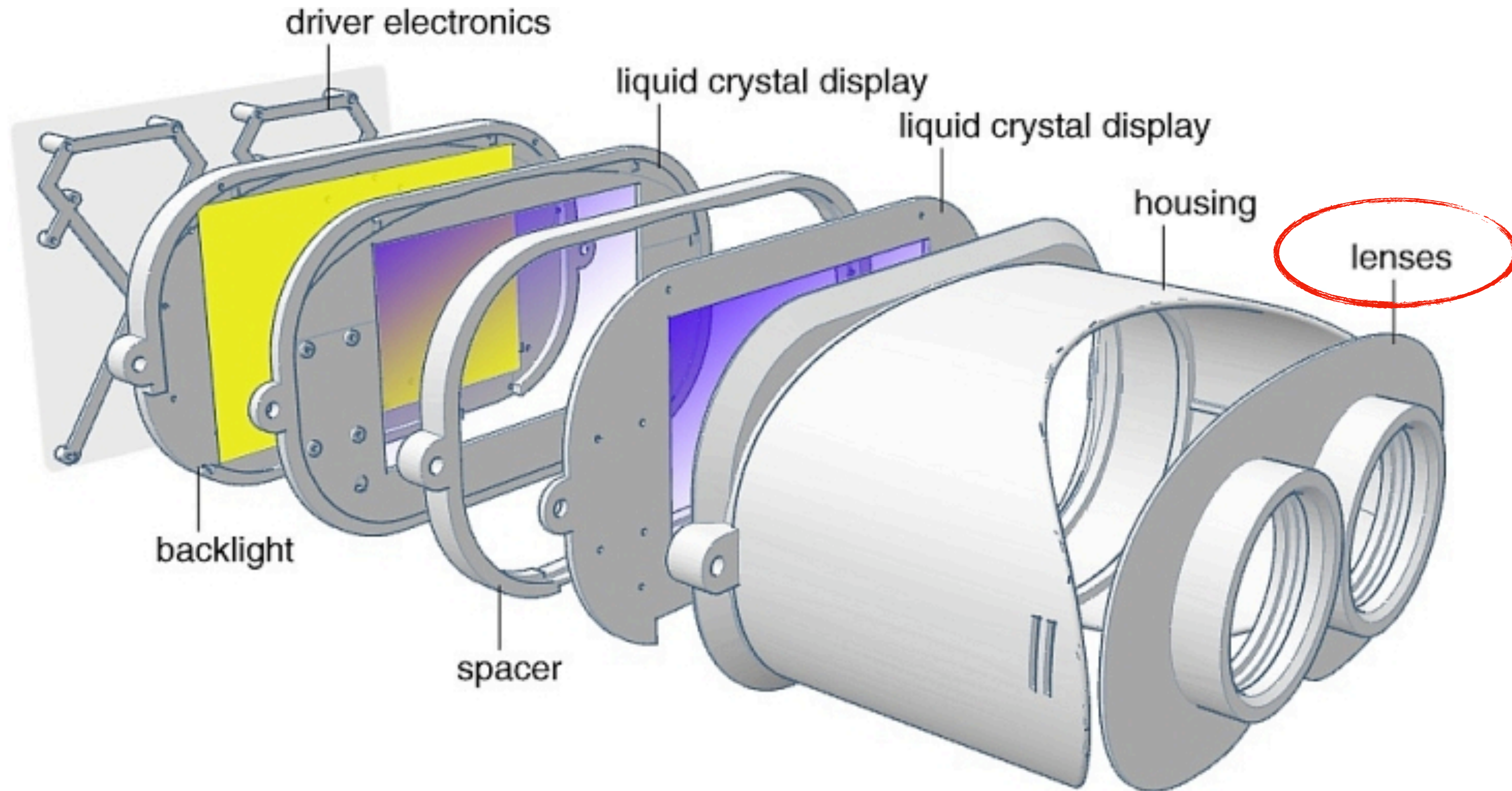

Figure 5.102 (a) An unaided view of an object. (b) The aided view through a magnifying glass. (c) A positive lens used as a magnifying glass. The object is less than one focal length from the lens.



Virtual Reality Display



Lenses in Virtual Reality Display

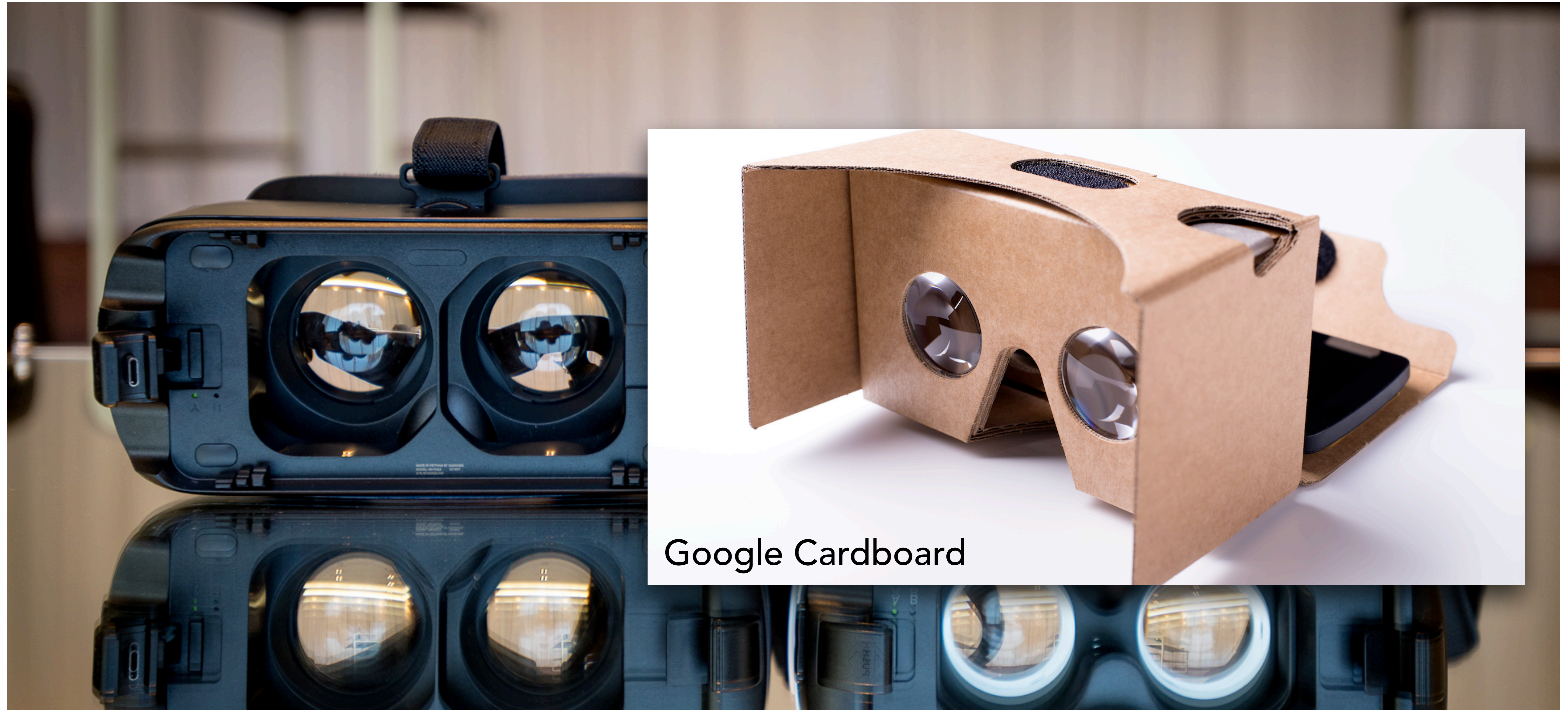

Google Cardboard

Lens in Virtual Reality Display

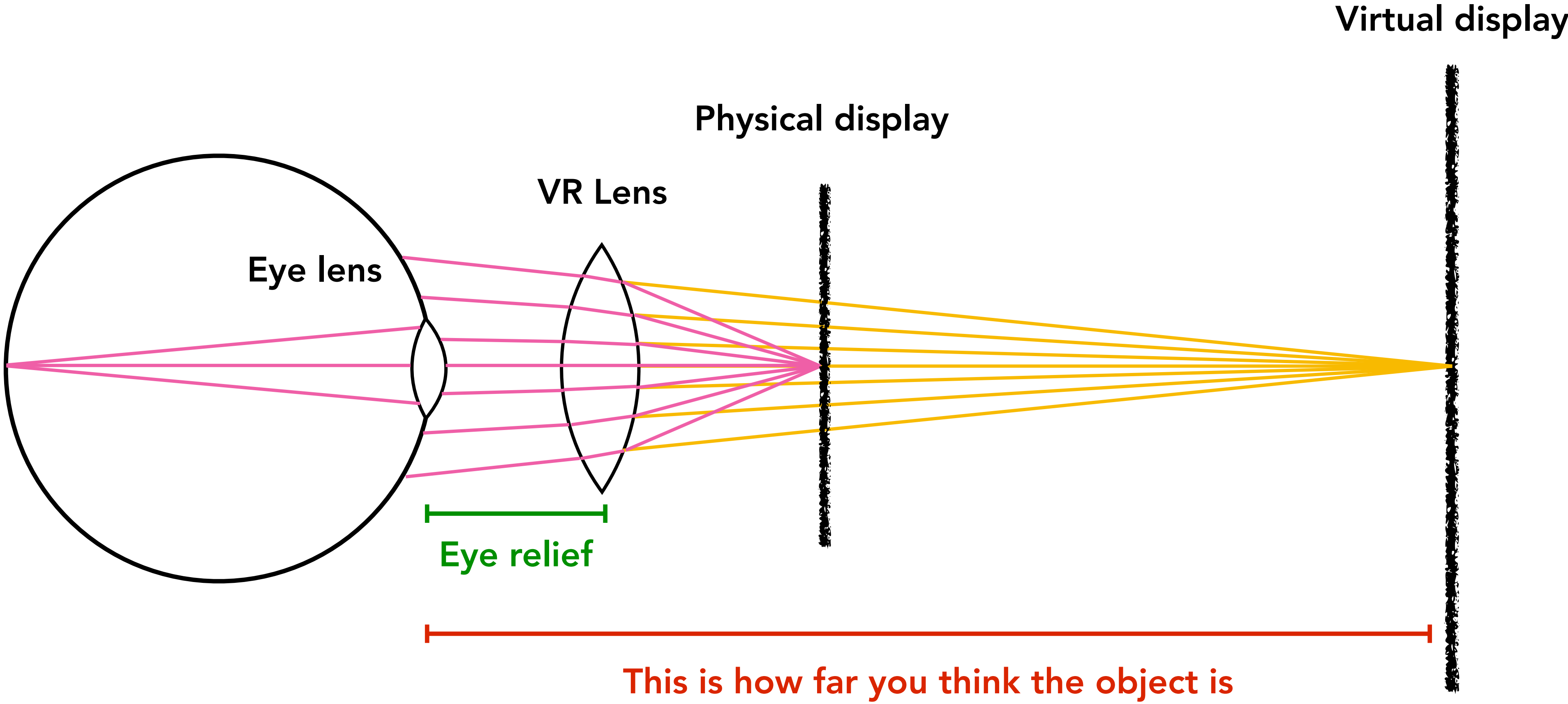

Magnification

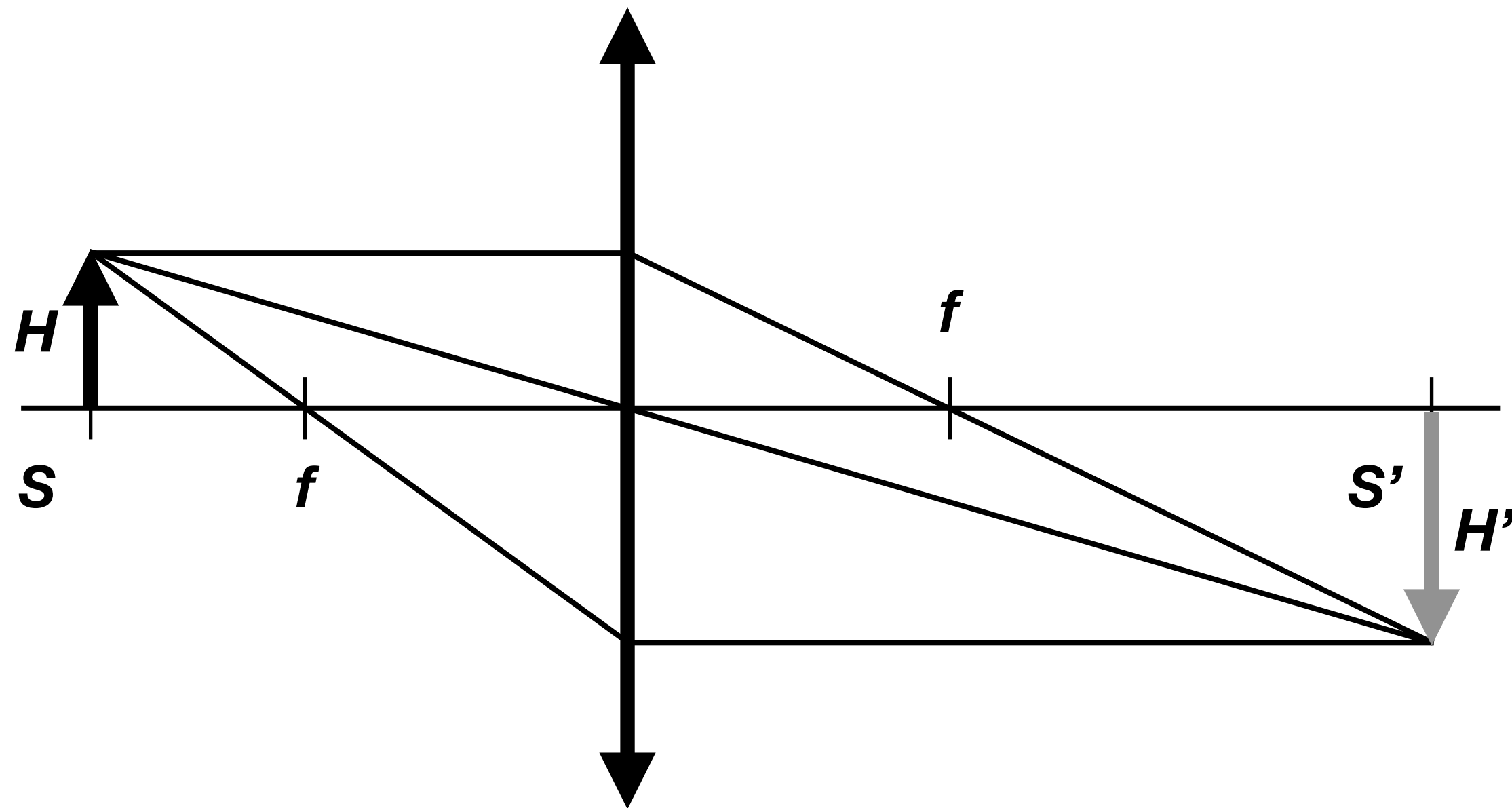

$$M = \frac{H'}{H} = \frac{f}{S - f} = \frac{1}{\frac{S}{f} - 1}$$

$$S = 2f \Rightarrow M = 1$$





Magnification

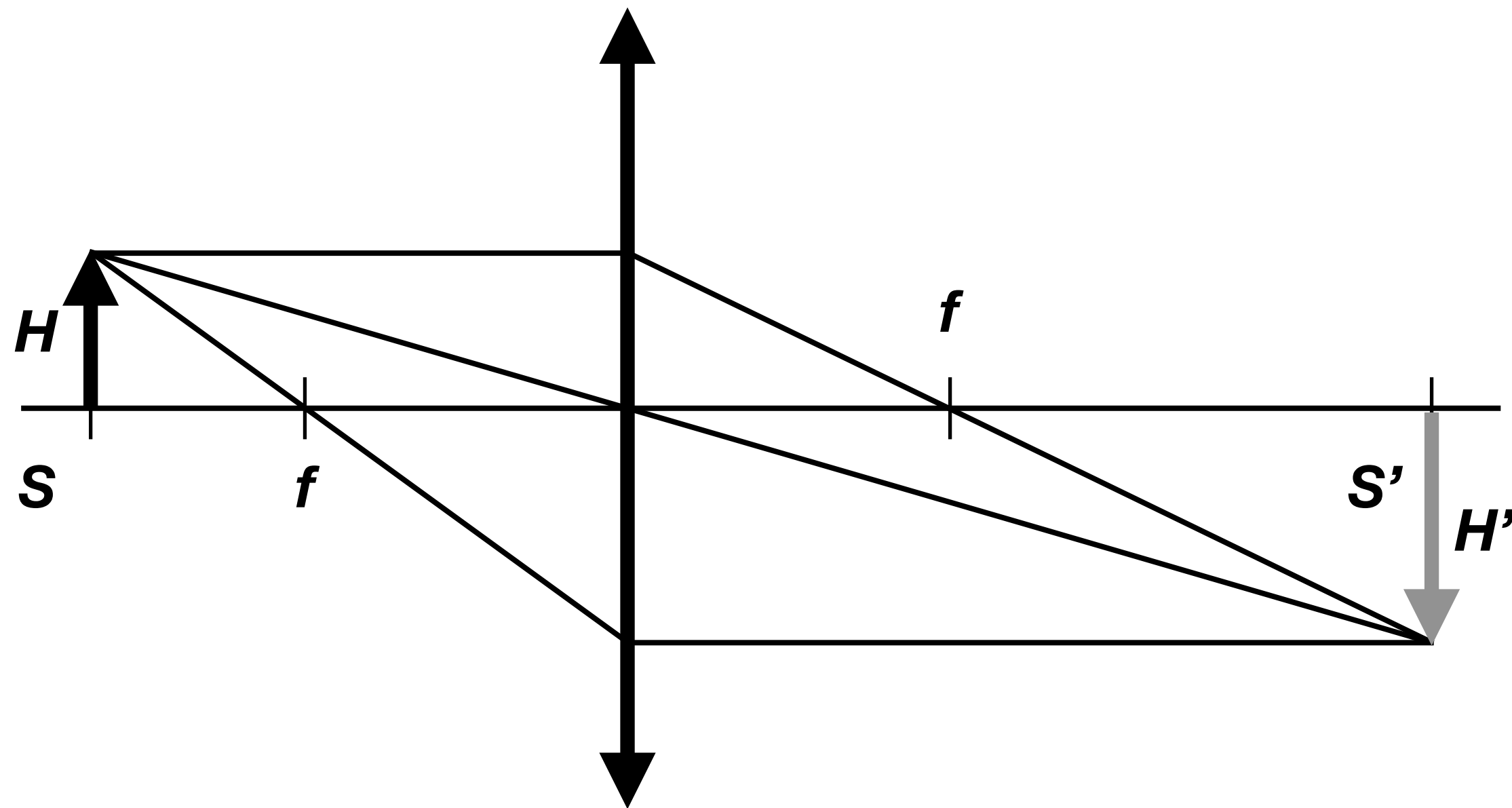

$$\boxed{M} = \frac{H'}{H} = \frac{f}{s - f} = \frac{1}{\frac{s}{f} - 1}$$

The diagram shows the magnification M is equal to the ratio of the image height H' to the object height H . This is also equal to the ratio of the focal length f to the object distance $s - f$. Finally, it is equal to the reciprocal of the quantity $\frac{s}{f} - 1$.

Increasing Focal Length

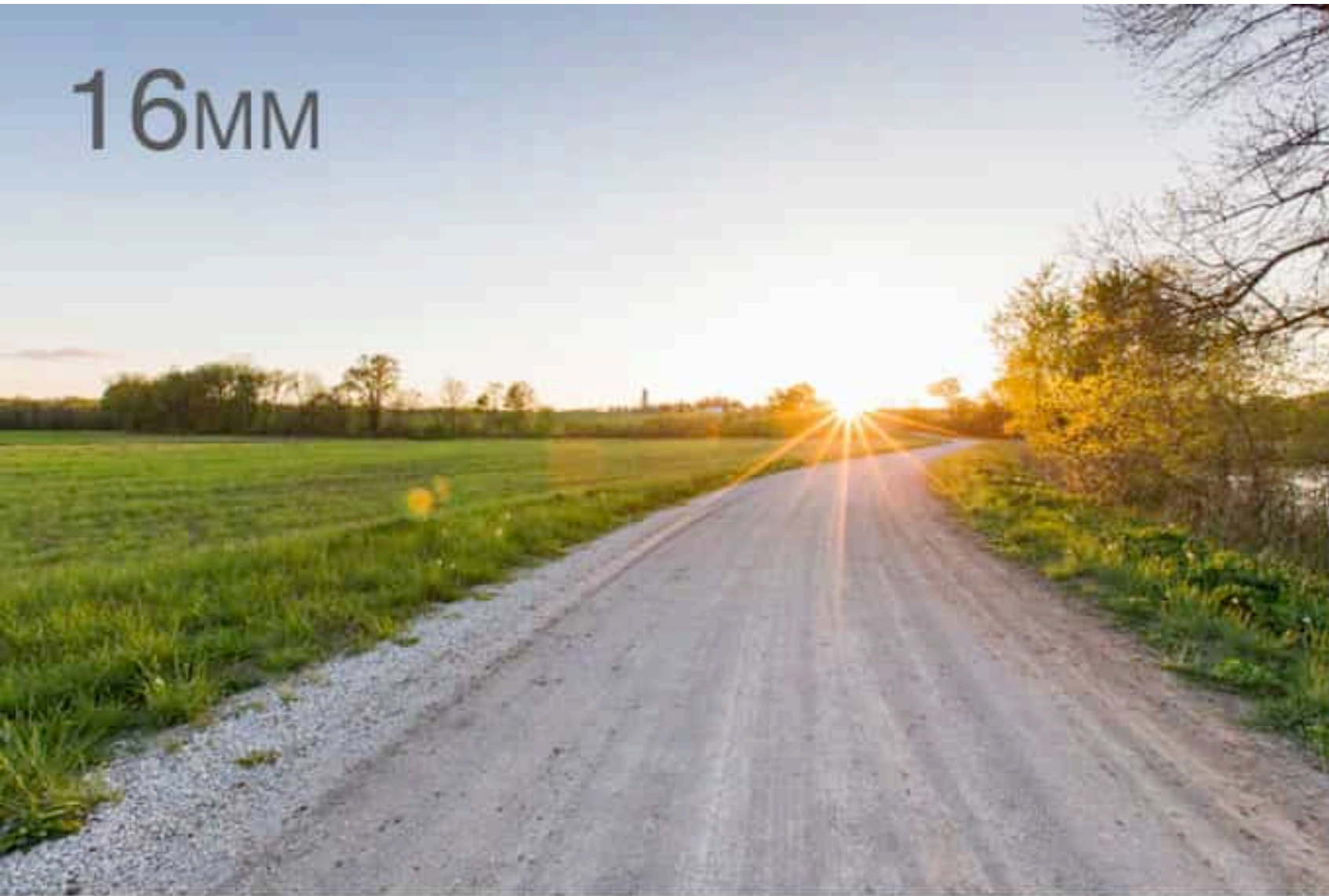

Increasing Focal Length Reduces Field of View

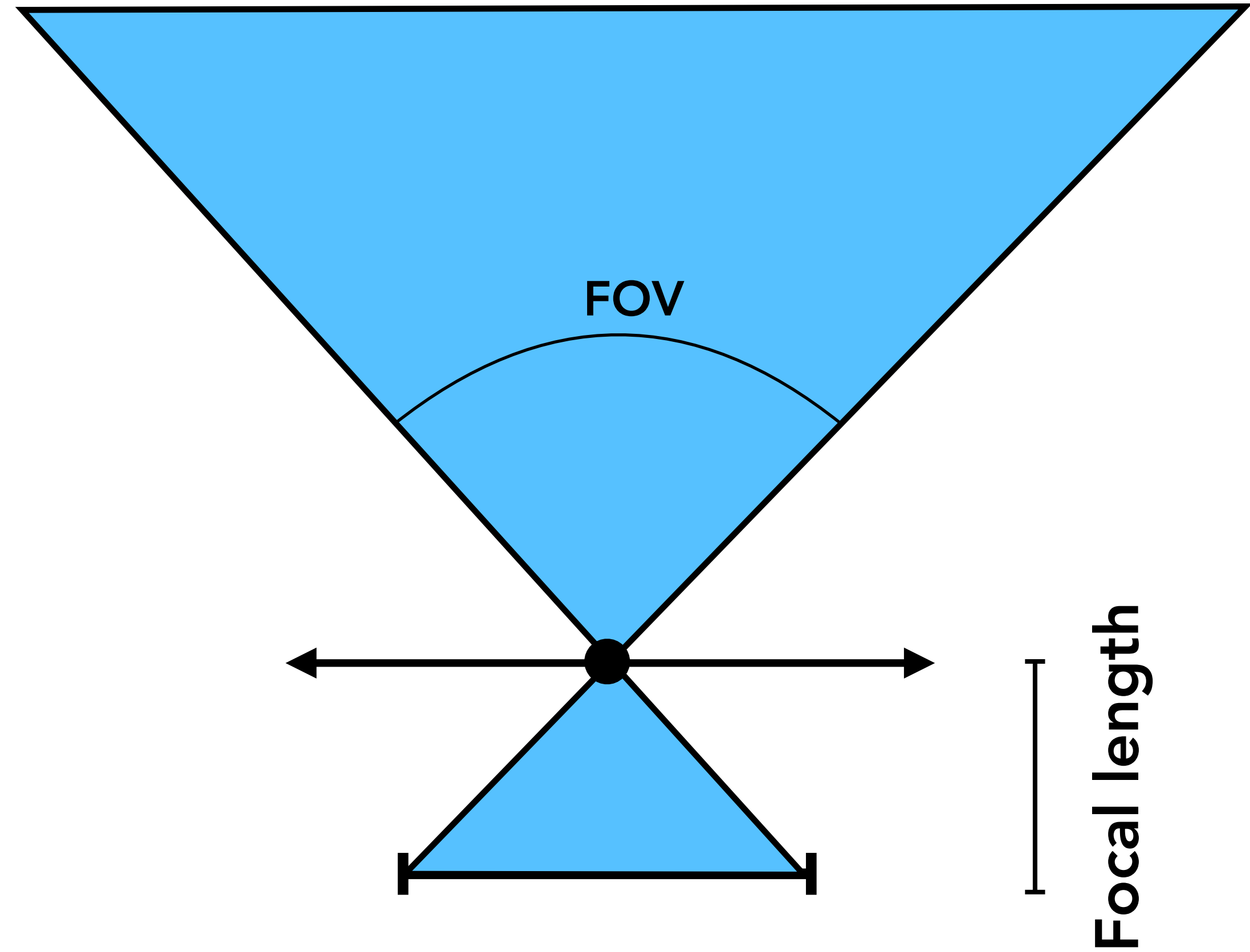
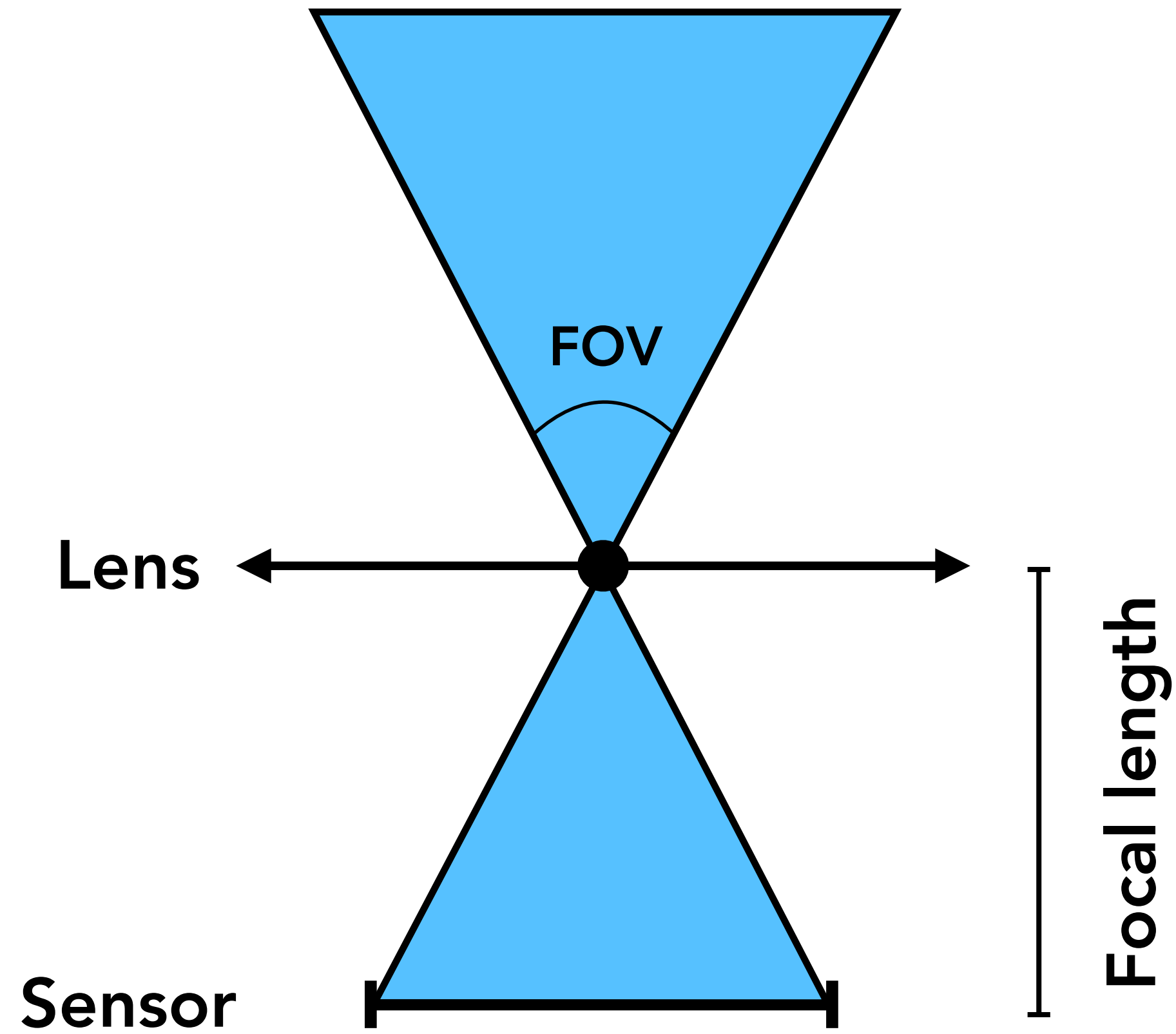

Focal Length vs. Field of View vs. Magnification

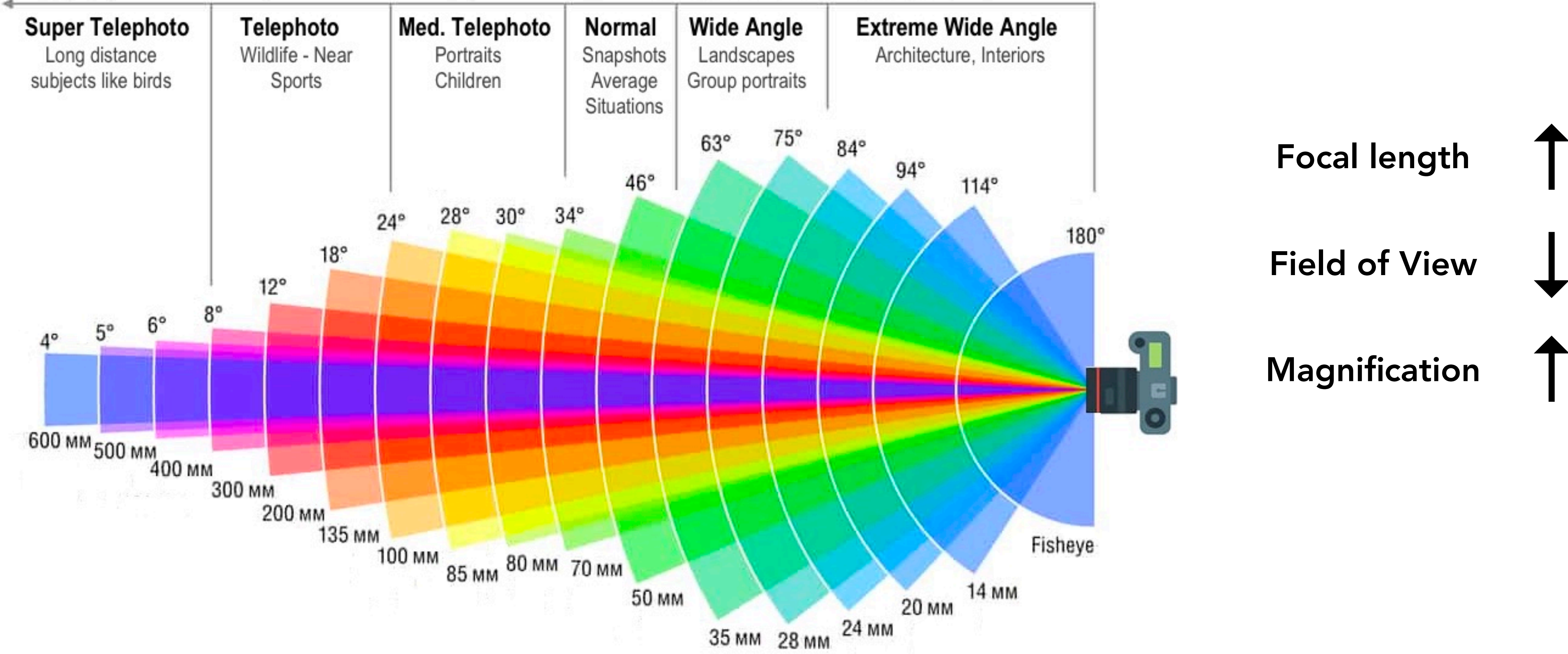

Focal Length vs. Field of View

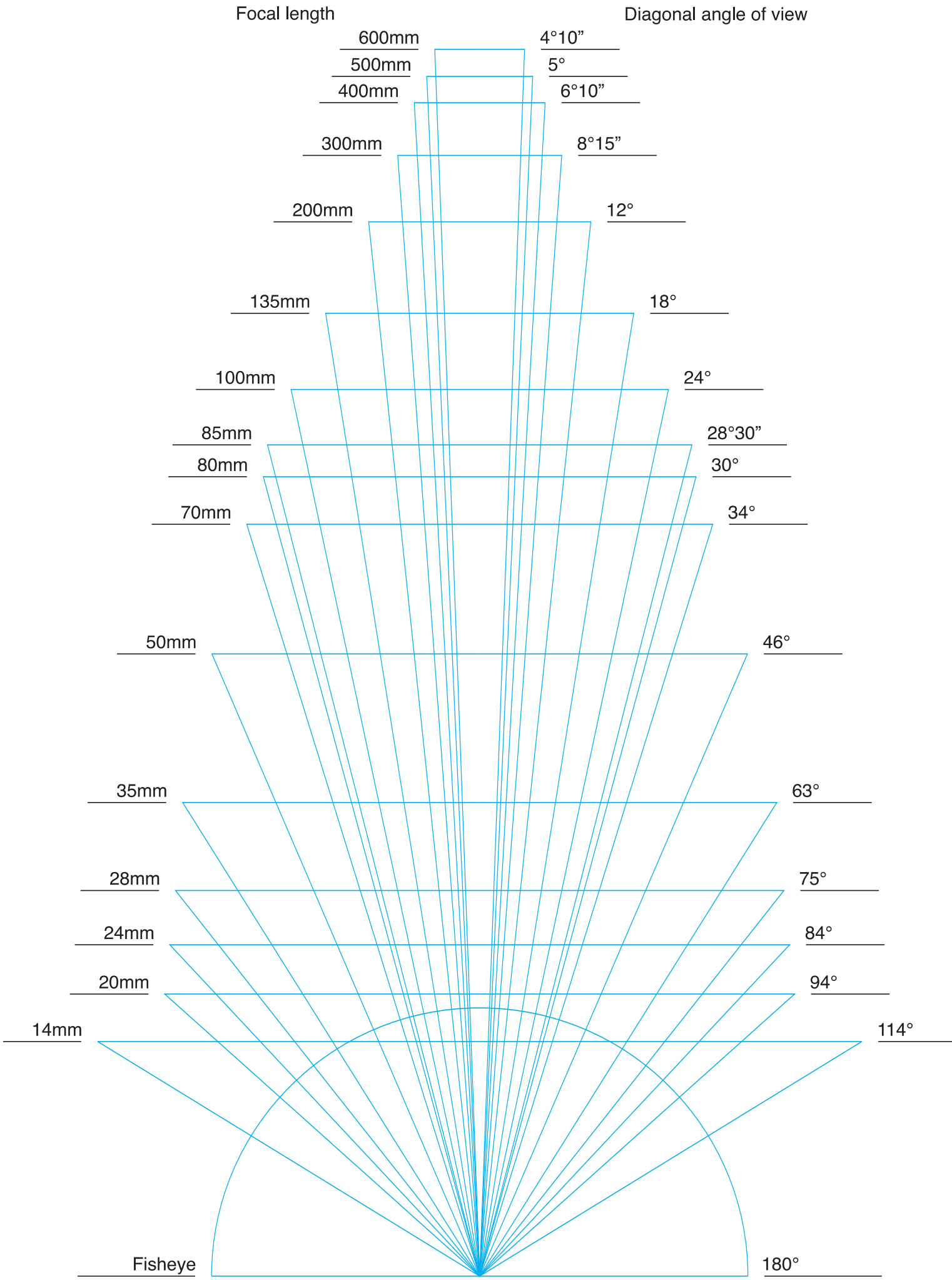

15mm (fisheye)



14mm



28mm



35mm



Focal Length vs. Field of View

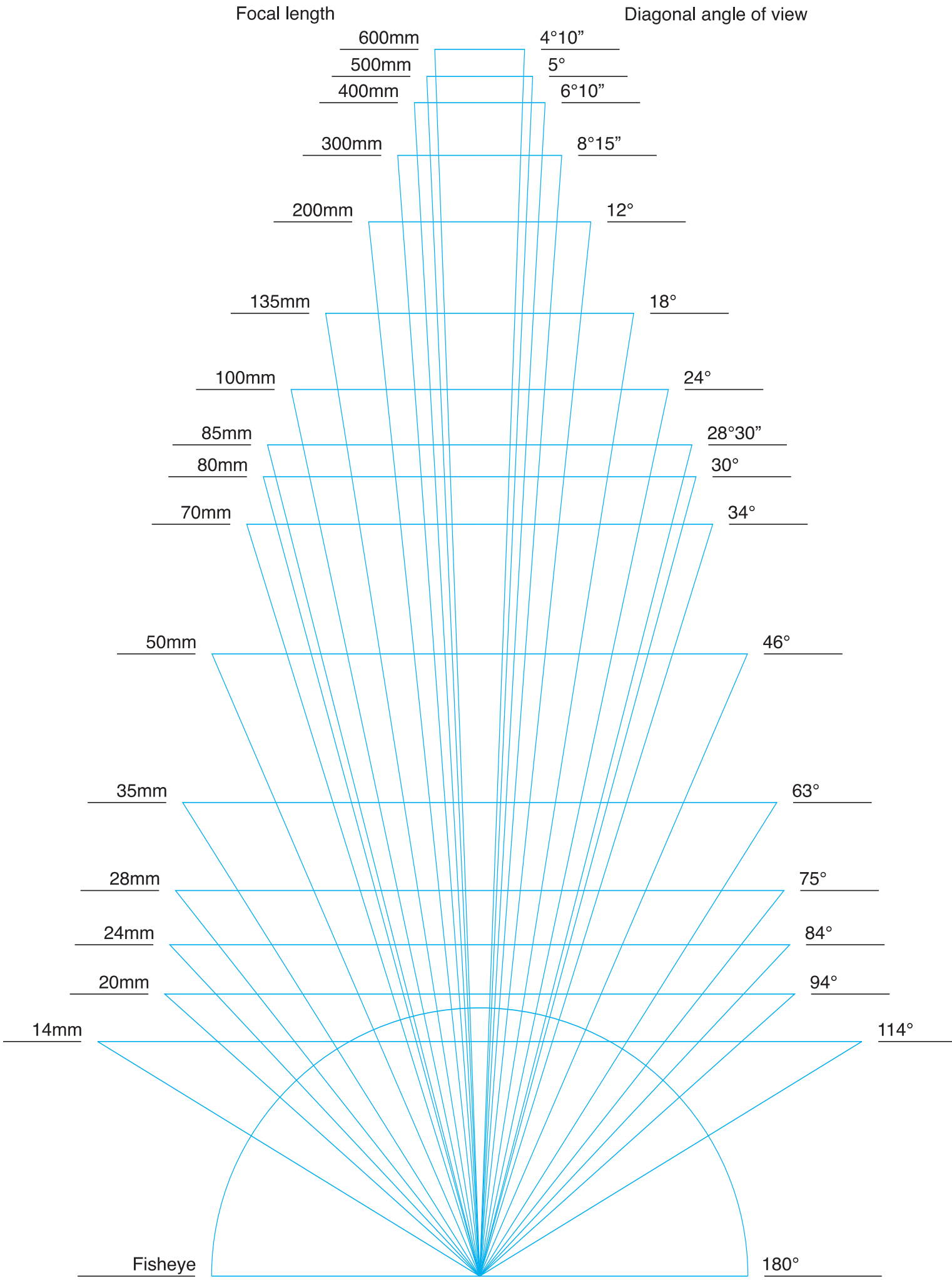

100mm 



135mm 

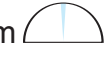

400mm 



600mm 



Telephoto Cameras



Real Lenses

Real Lenses are Very Complex

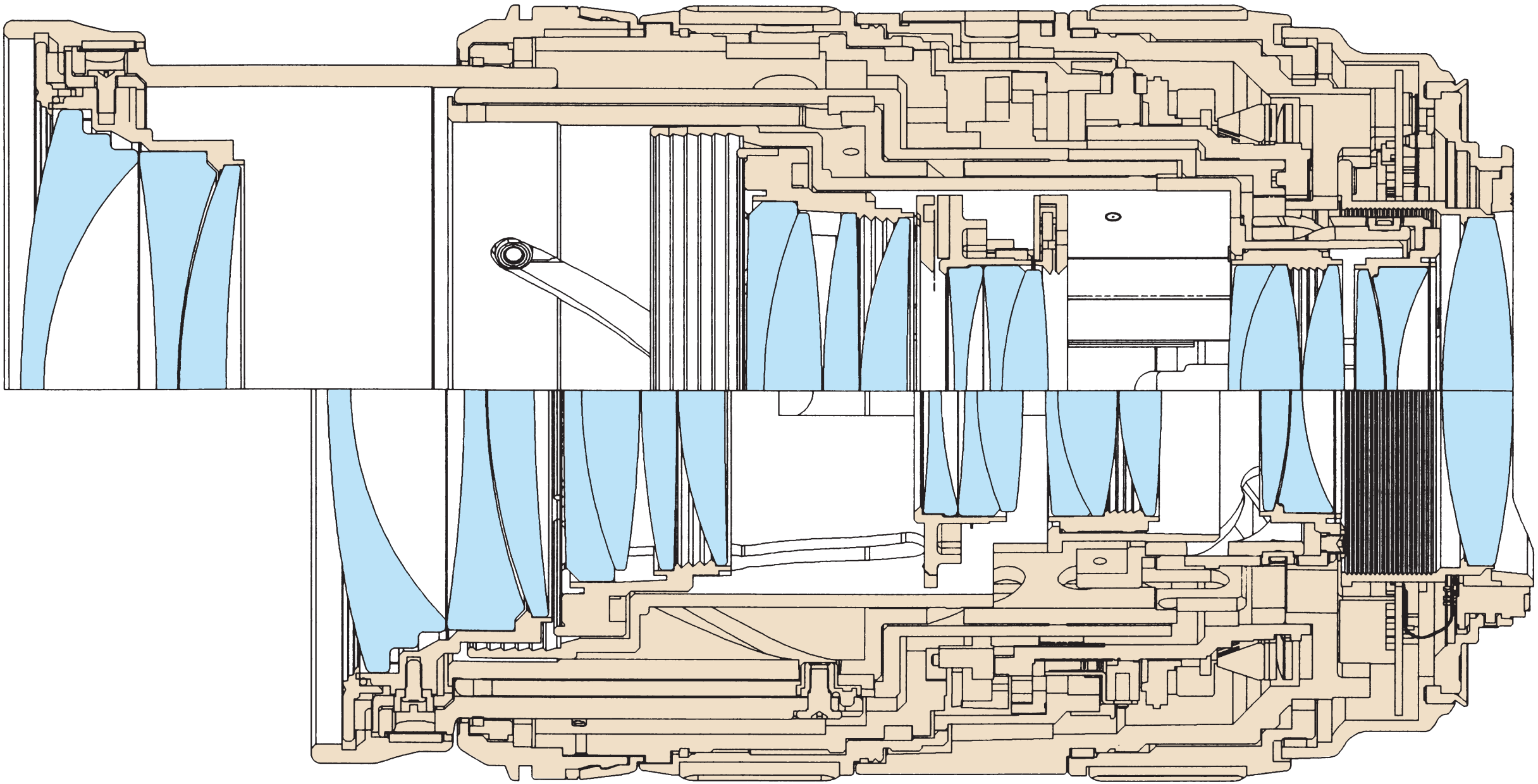
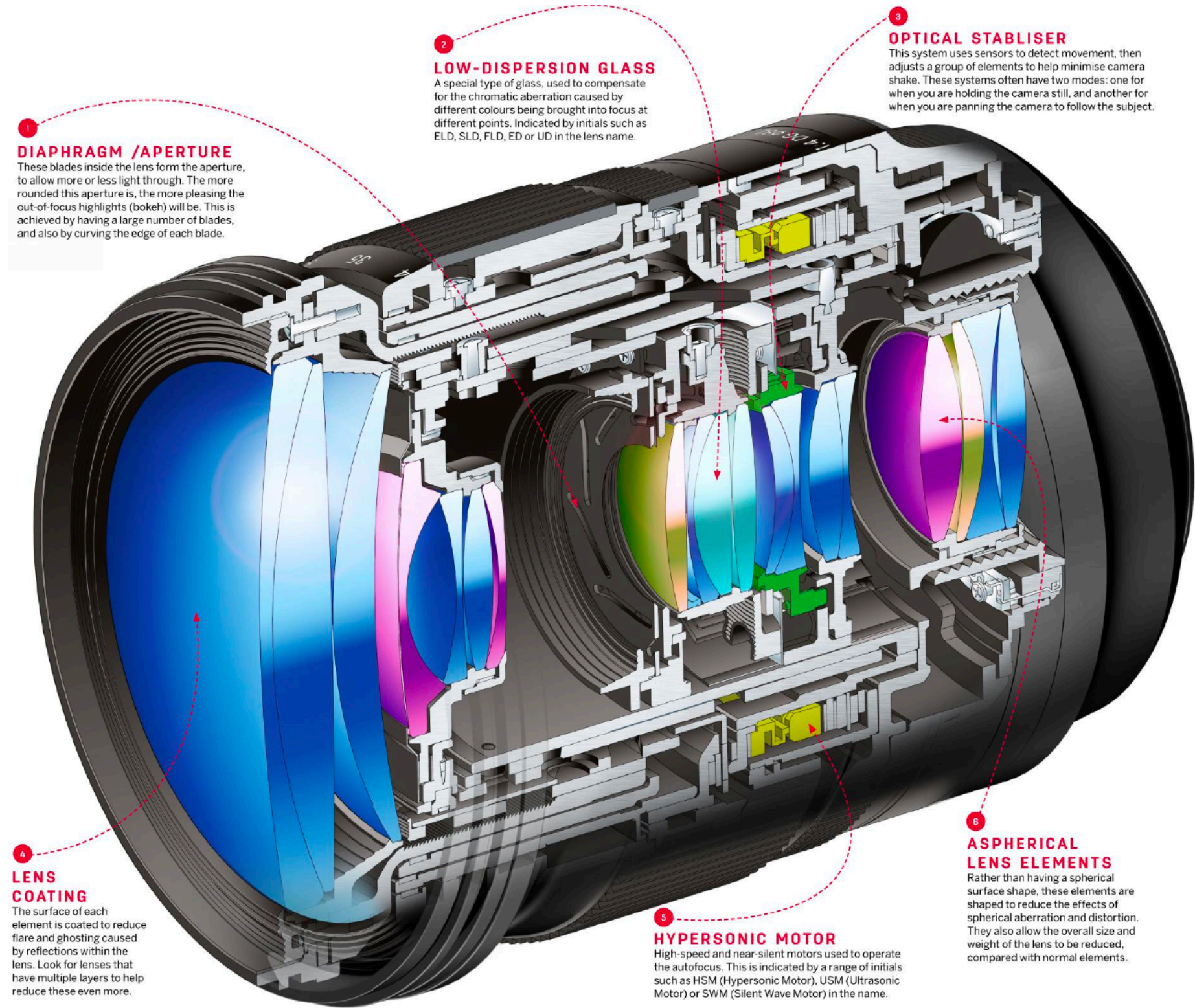

Cross section of the EF 24-70 mm f/2.8

Real Lenses are Very Complex

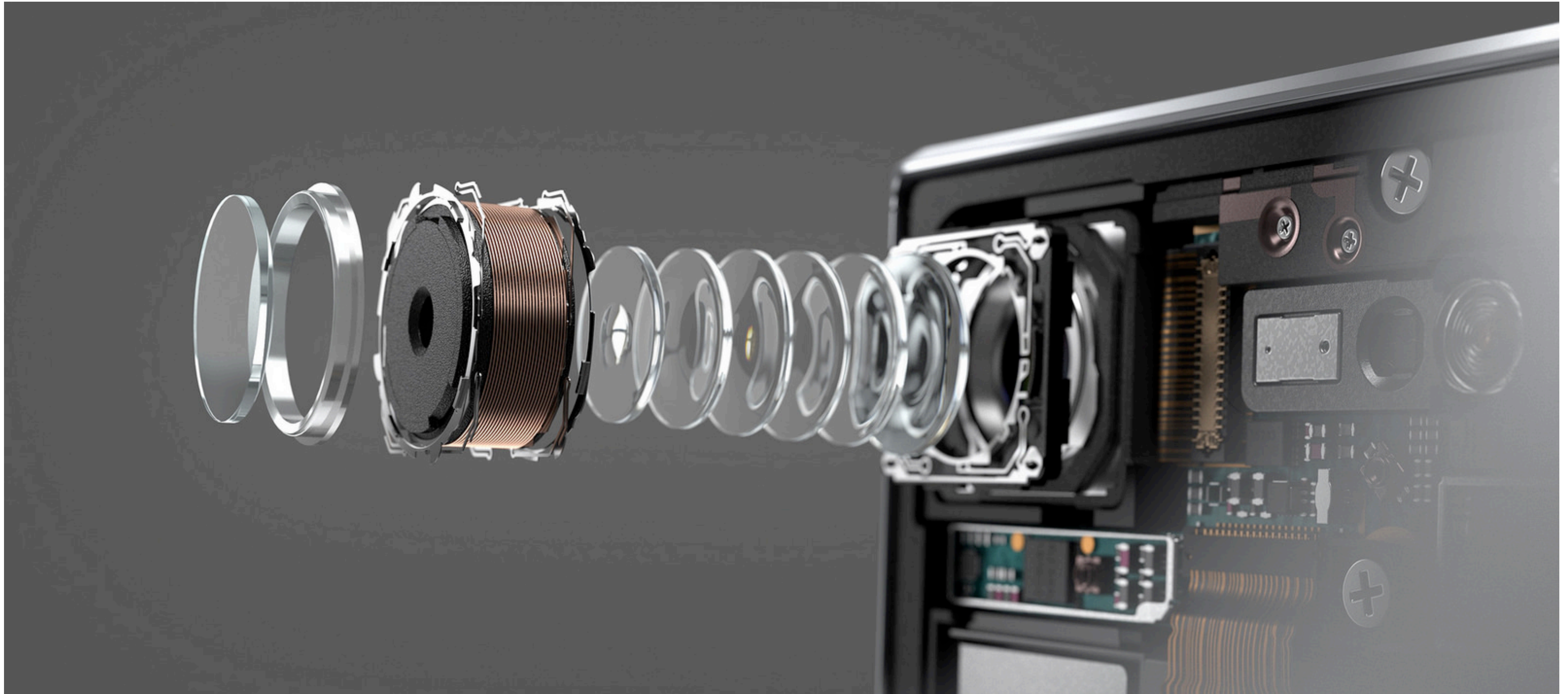

Real Lenses

So far we've assumed **thin** lens and **paraxial** approximations.

Real lenses are neither thin nor can we ignore non-paraxial rays.

So real lens behaviors deviate away from ideal lens, but the same geometrical optics principles still apply.

A typical strategy to correct deviations from ideal lenses is to cascade a sequence of lenses, i.e., **compound** lens.

Thick Lens Geometry

The same geometric principles still apply; need to consider more parameters. Simplifications made for thin lenses won't apply.

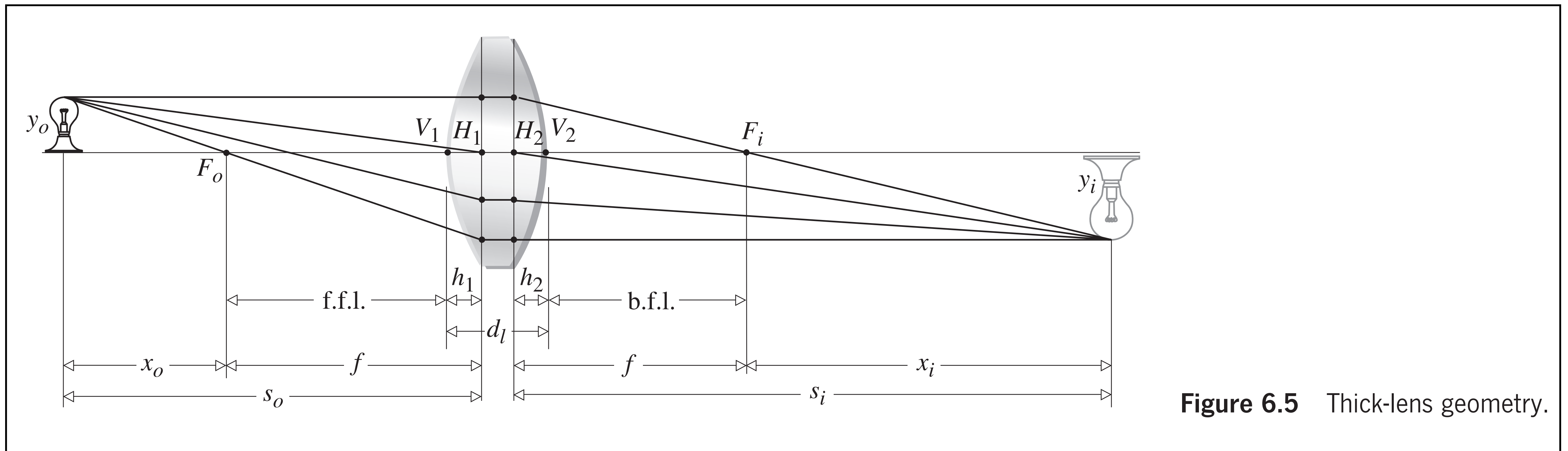

Figure 6.5 Thick-lens geometry.

Lens Aberrations

Recall paraxial rays are rays that stay close to optical axis throughout the system. These rays:

- are originated from objects close to/on optical axis **AND**
- have a small incident angle when approaching the lens

(Monochromatic) **aberrations** refer to deviations from ideal lens when considering non-paraxial rays, i.e.,:

- Rays that are not originated from from objects close to/on optical axis **OR**
- Have oblique incident angles

Lens Aberrations

$$\sin \phi = \phi - \frac{\phi^3}{3!} + \frac{\phi^5}{5!} - \frac{\phi^7}{7!} + \dots$$

When considering the second term of Taylor series expansion (compared to considering only the first term), five forms of aberrations show up:

- spherical aberration, coma, astigmatism, field curvature, distortion
- This is called *third-order* theory, c.f. paraxial approximation (which is called first-order theory or Gaussian Optics).

Higher-order aberrations show up when considering additional terms.

Chromatic aberrations:

- arise from the fact that refractive index is actually a function of frequency.

Spherical Aberration

For a spherical lens:

- For a point on the optical axis, its non-paraxial rays will not focus at the same point.
- By extension, not all parallel rays (which includes non-paraxial parallel rays) focus at the same point.

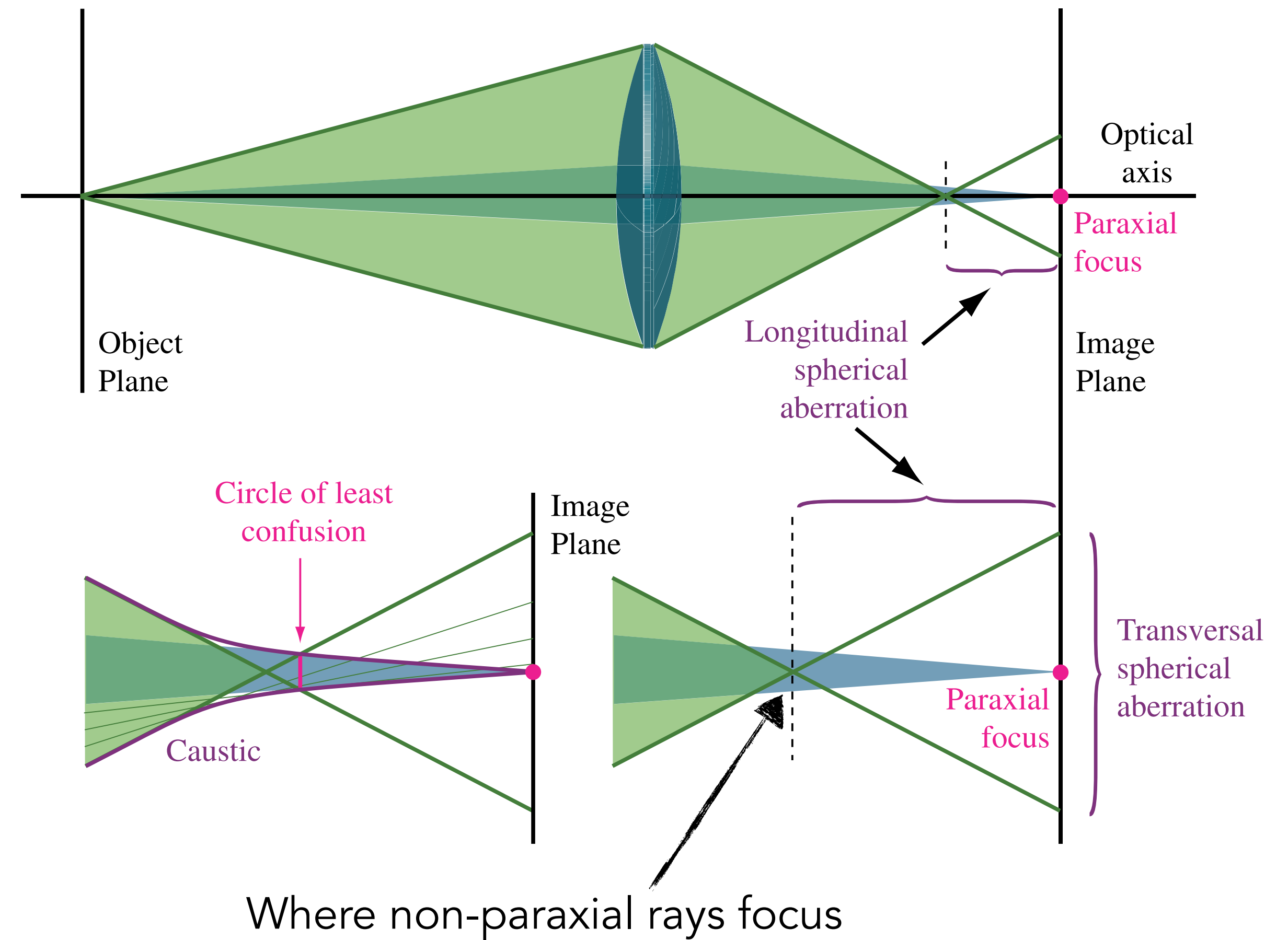

Spherical Aberration

For a spherical lens:

- For a point on the optical axis, its non-paraxial rays will not focus at the same point.
- By extension, not all parallel rays (which includes non-paraxial parallel rays) focus at the same point.

Fixing spherical aberrations:

- Using a combination of convex and concave lens
- Using aspherical/hyperbolic lens

Spherical lens

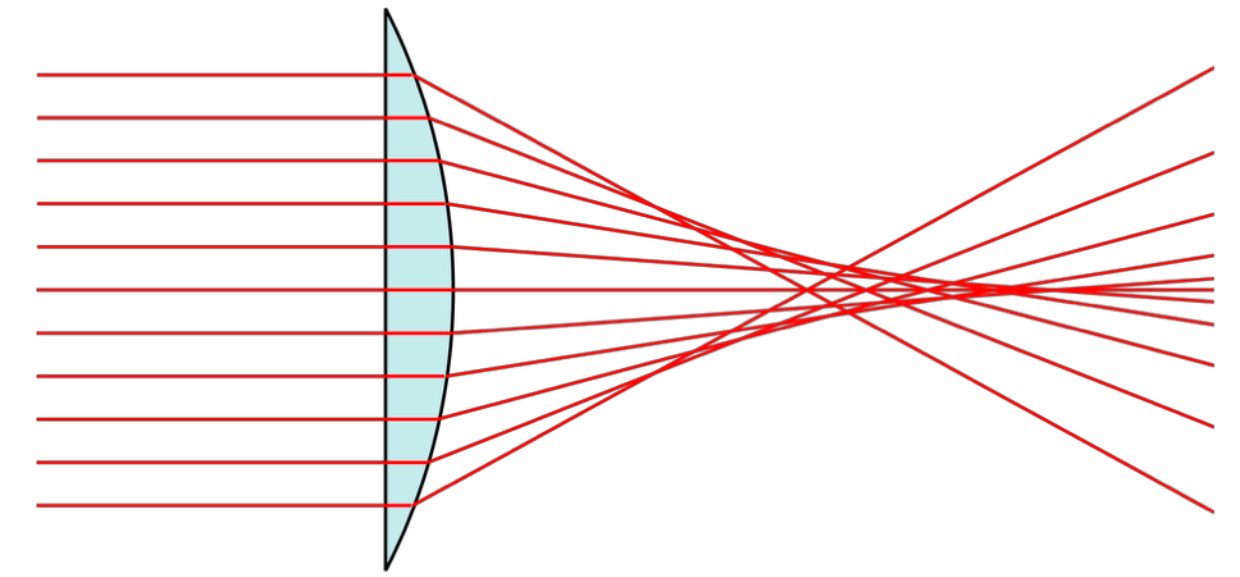

Hyperbolic lens

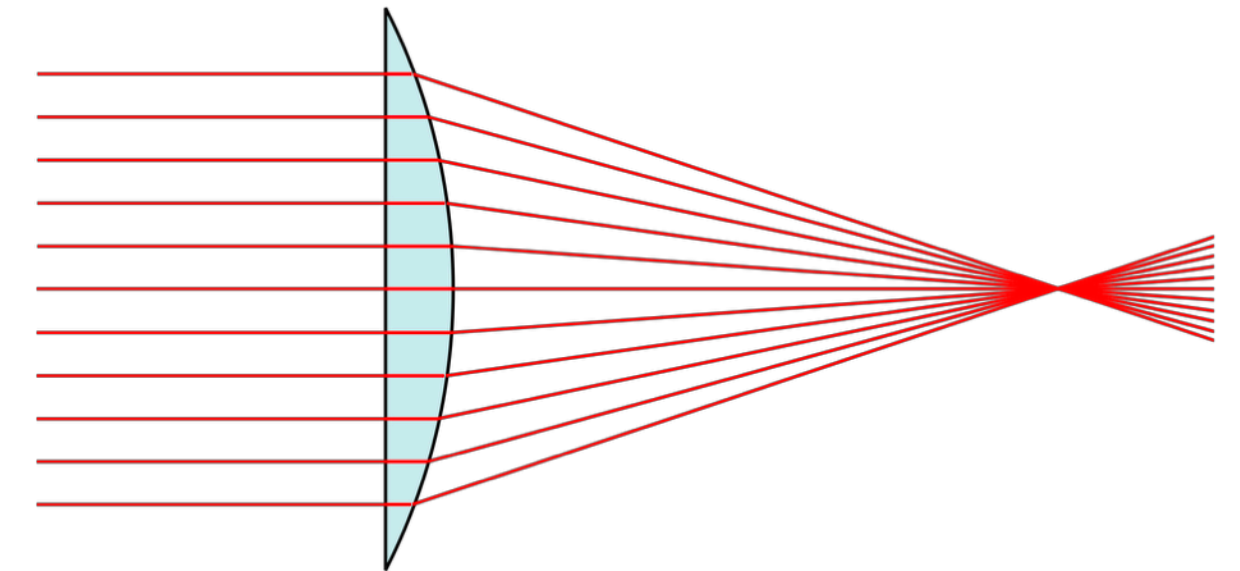

Aspherical lens

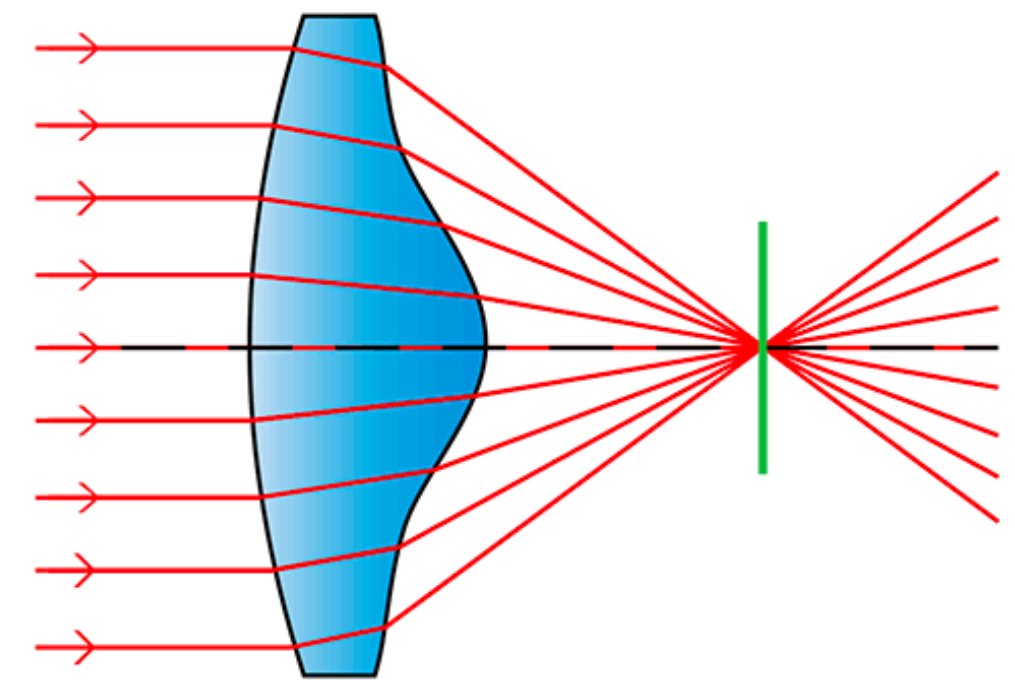

Spherical Aberration

Hubble Space Telescope images of the M-100 galaxy with (before repair) and without (after repair) spherical aberration.



Spherical Aberration in Mirrors

Spherical Mirror

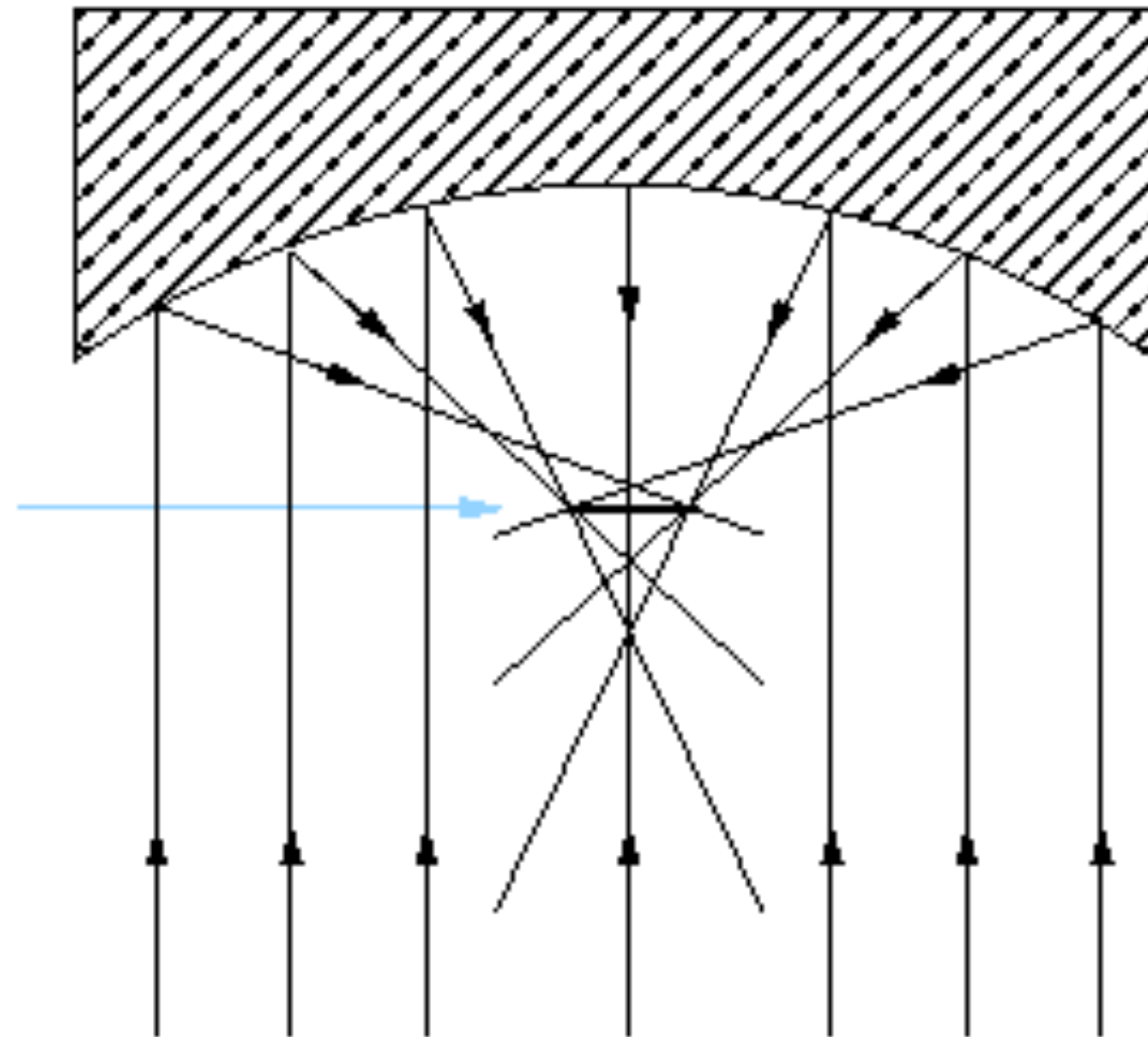

Hyperbolic Mirror

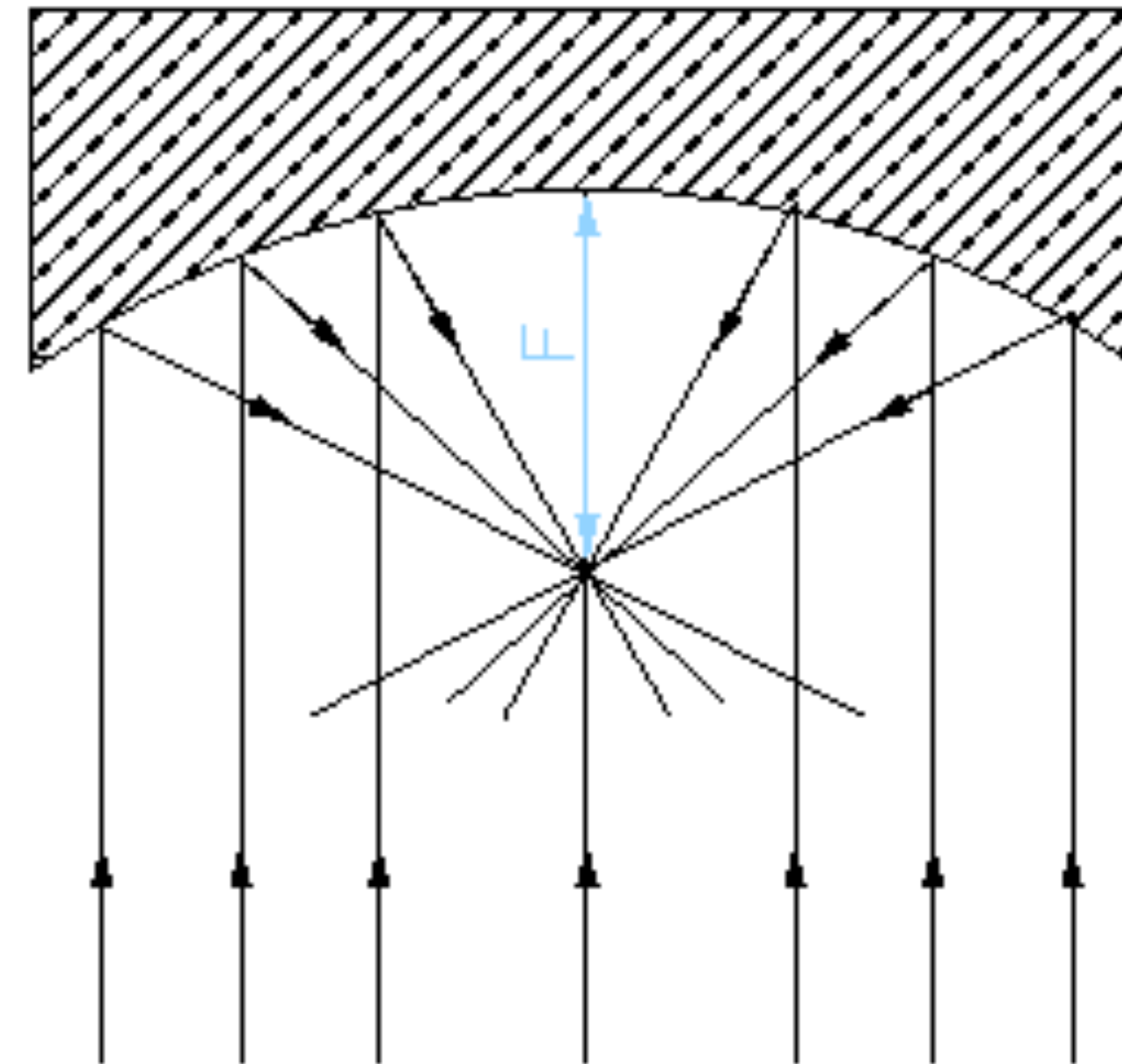

Could It Have Been Possible?

- Could Archimedes have made hyperbolic mirrors?
- Could the ships have happened to be at the focal point?
- Was there enough power?

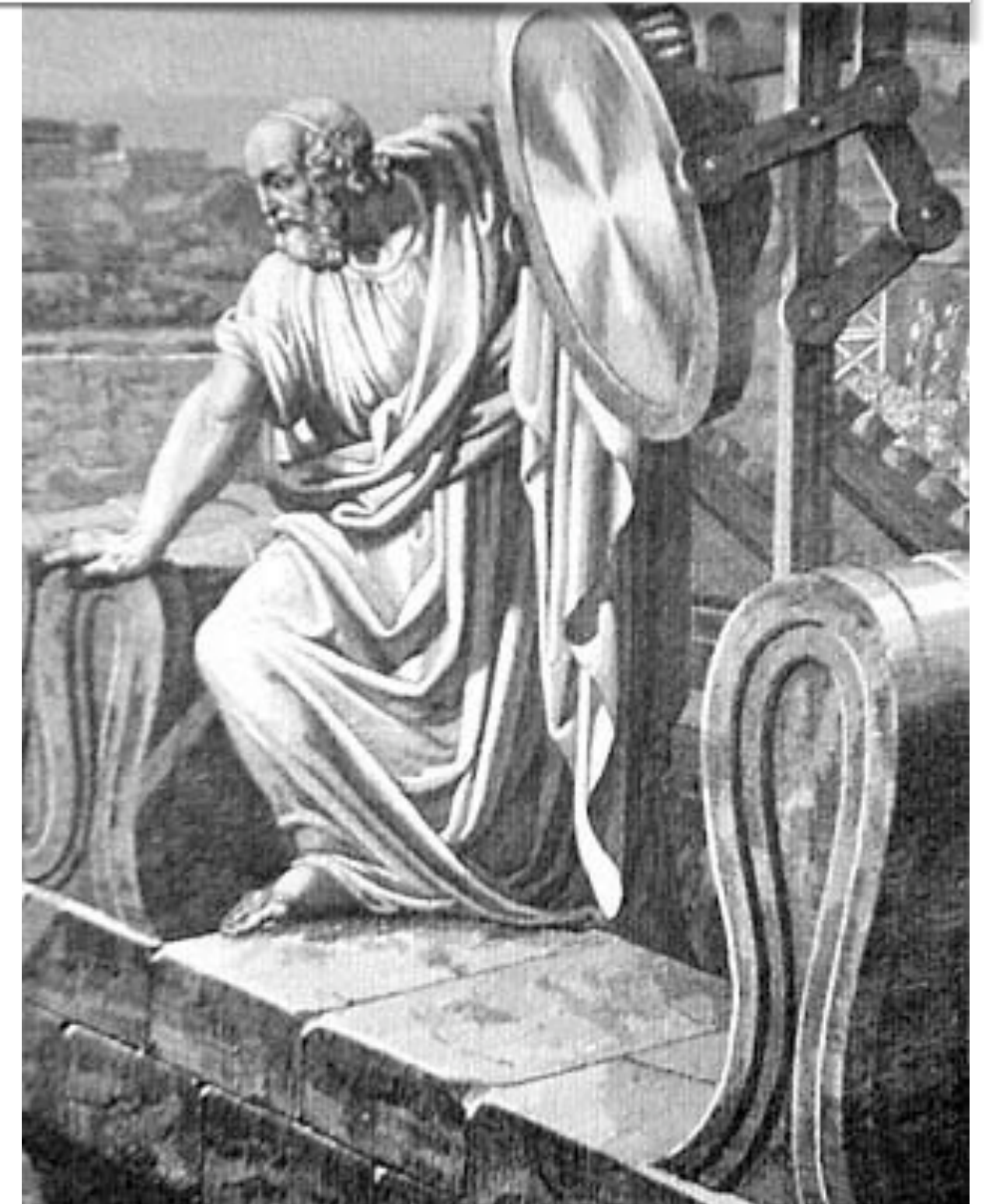
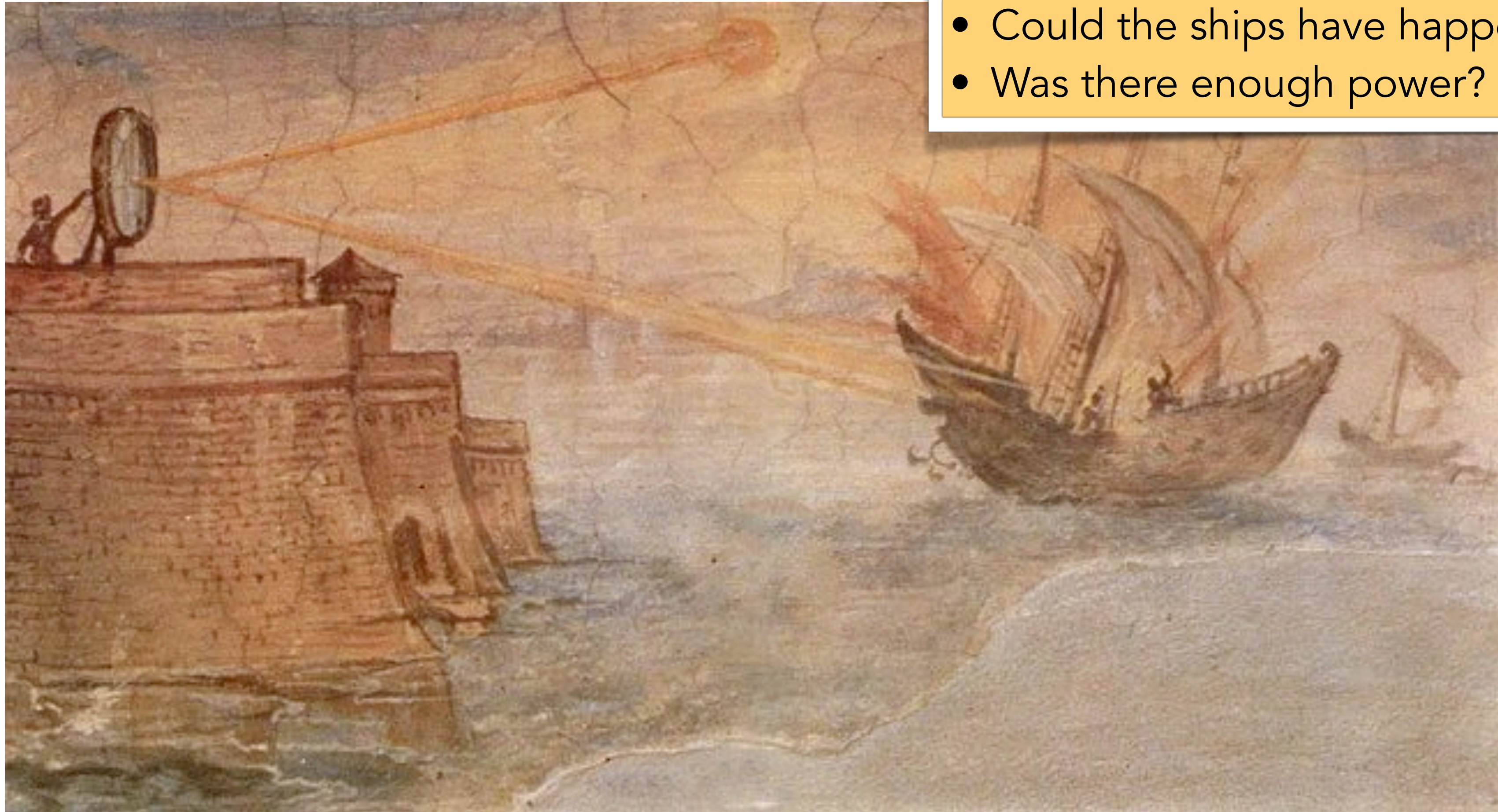

Coma

Rays from an off-axis point focus on different points. By extension, parallel rays that are not parallel to the optical axis don't focus on the same point.

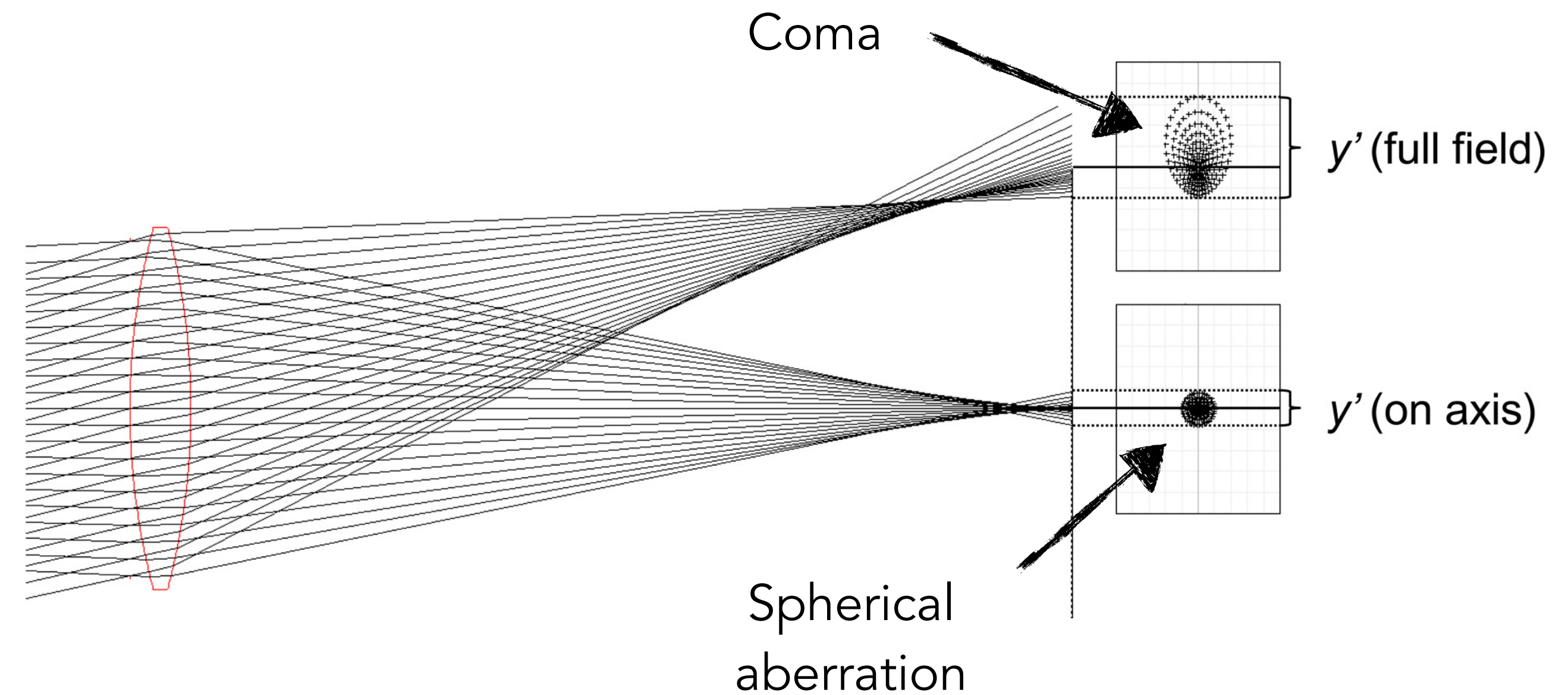
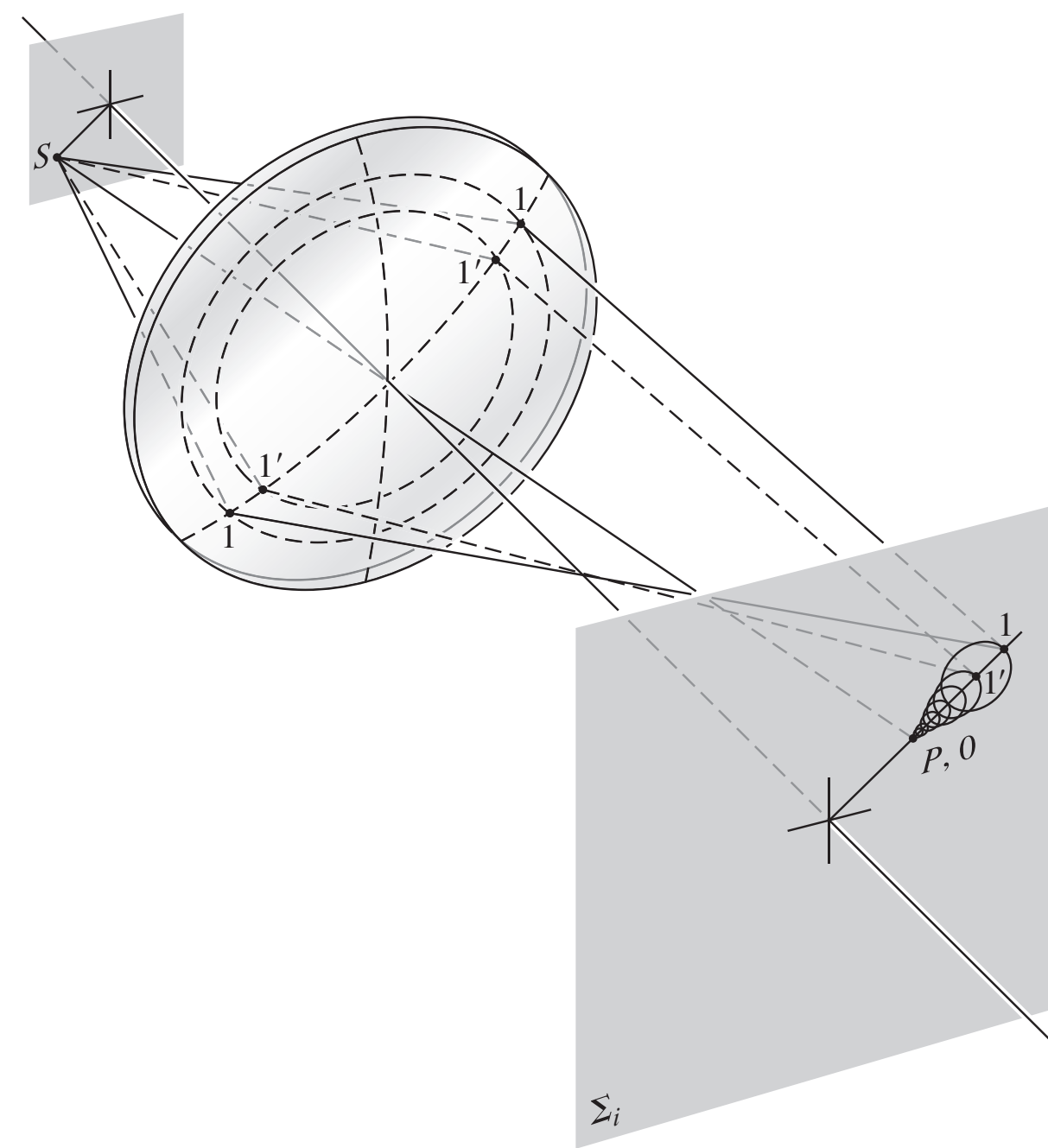

Astigmatism

Original	Compromise
aio	aio
Horizontal Focus	Vertical Focus
aio	aio

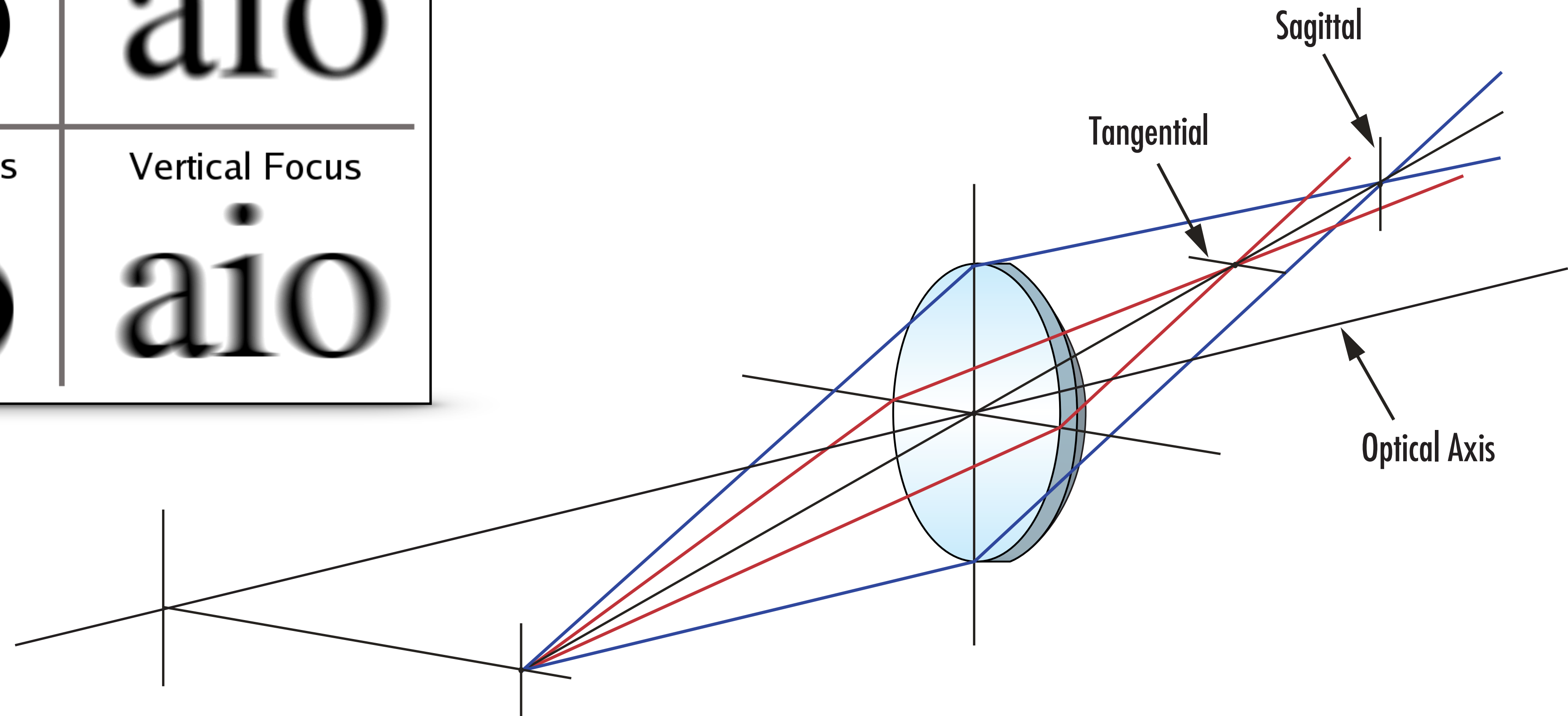

Field Curvature

If a lens is free from all previous aberrations, a scene point is sharply imaged on a point on the sensor; but the image "plane" is actually a curved surface.

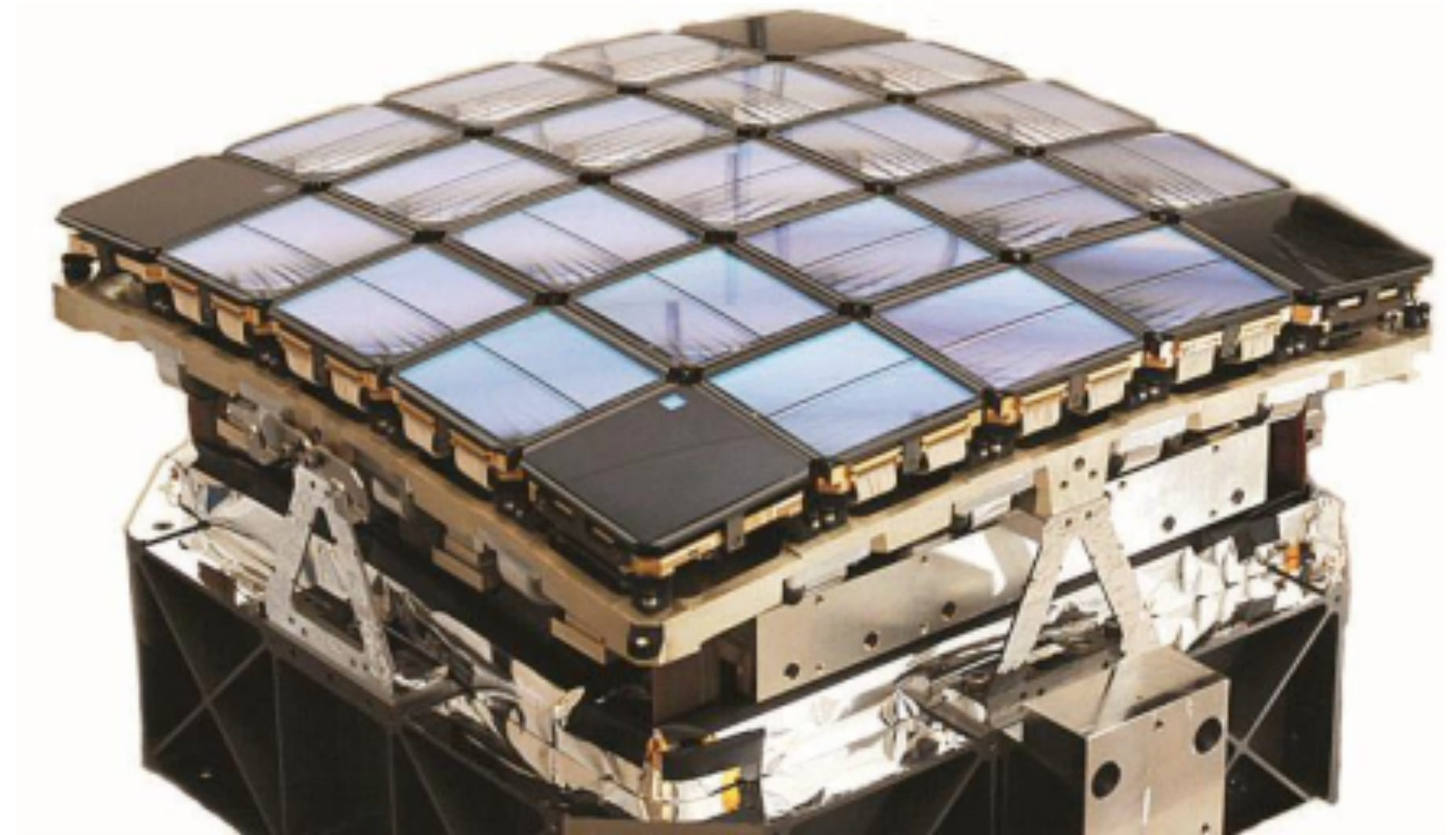
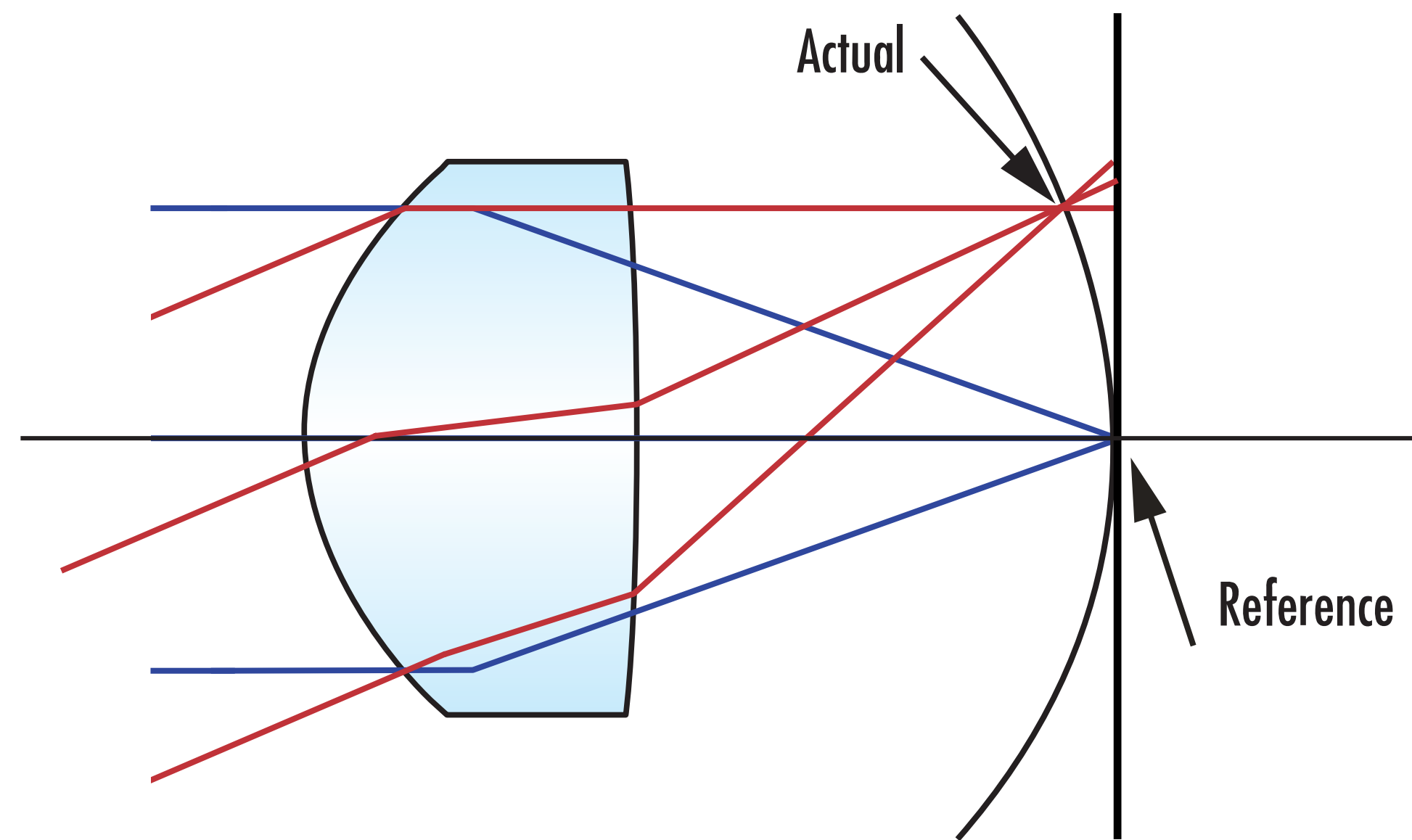

The image-sensor array of the Kepler space observatory is curved to compensate for the field curvature.

Distortion

Pinhole cameras and ideal lens perform perspective projections, where straight lines remain straight in images.

Distortion is deviation from perspective projection. It is more significant at the extremities of the lens.

Fisheye lens is an extreme example.

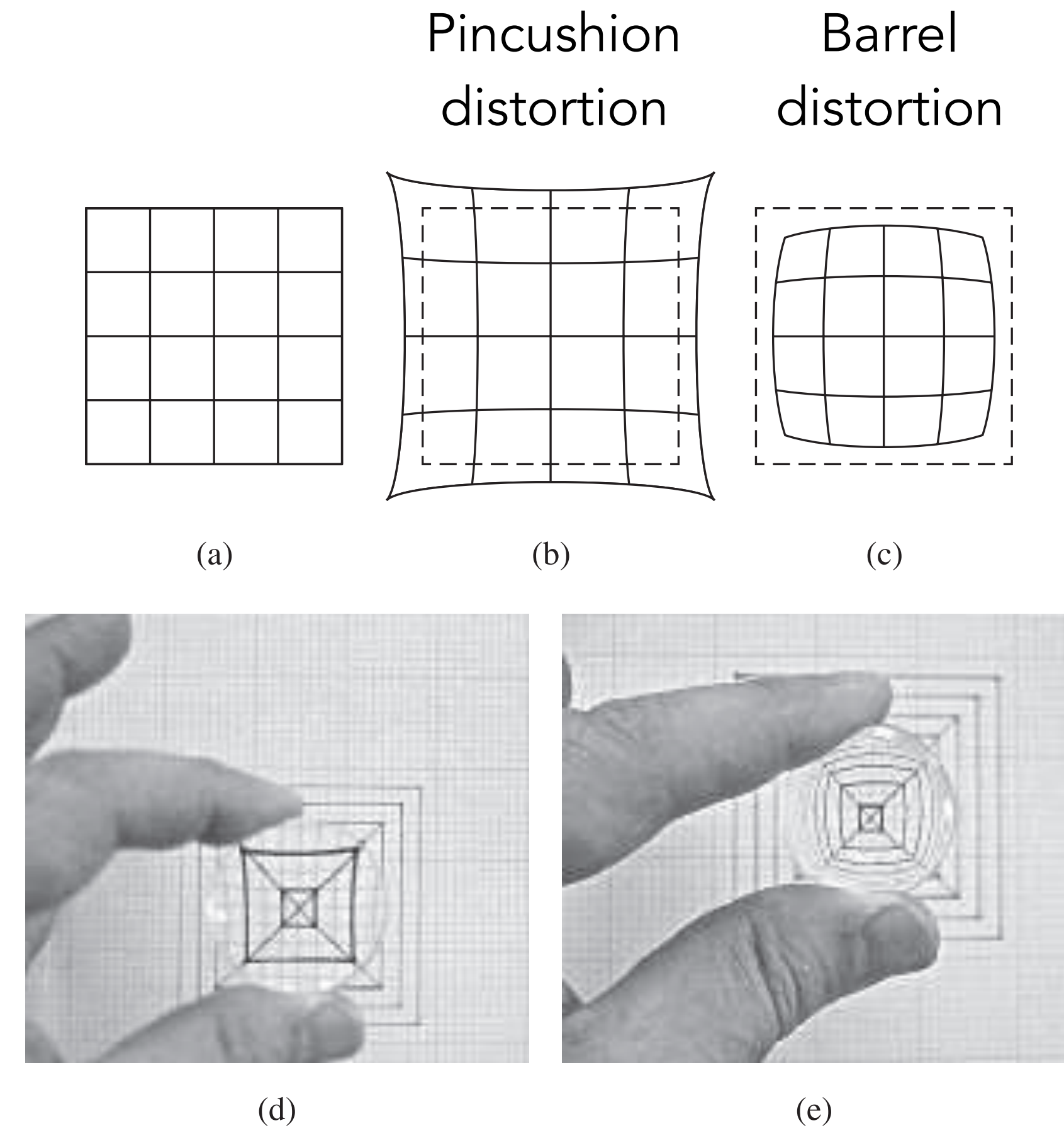
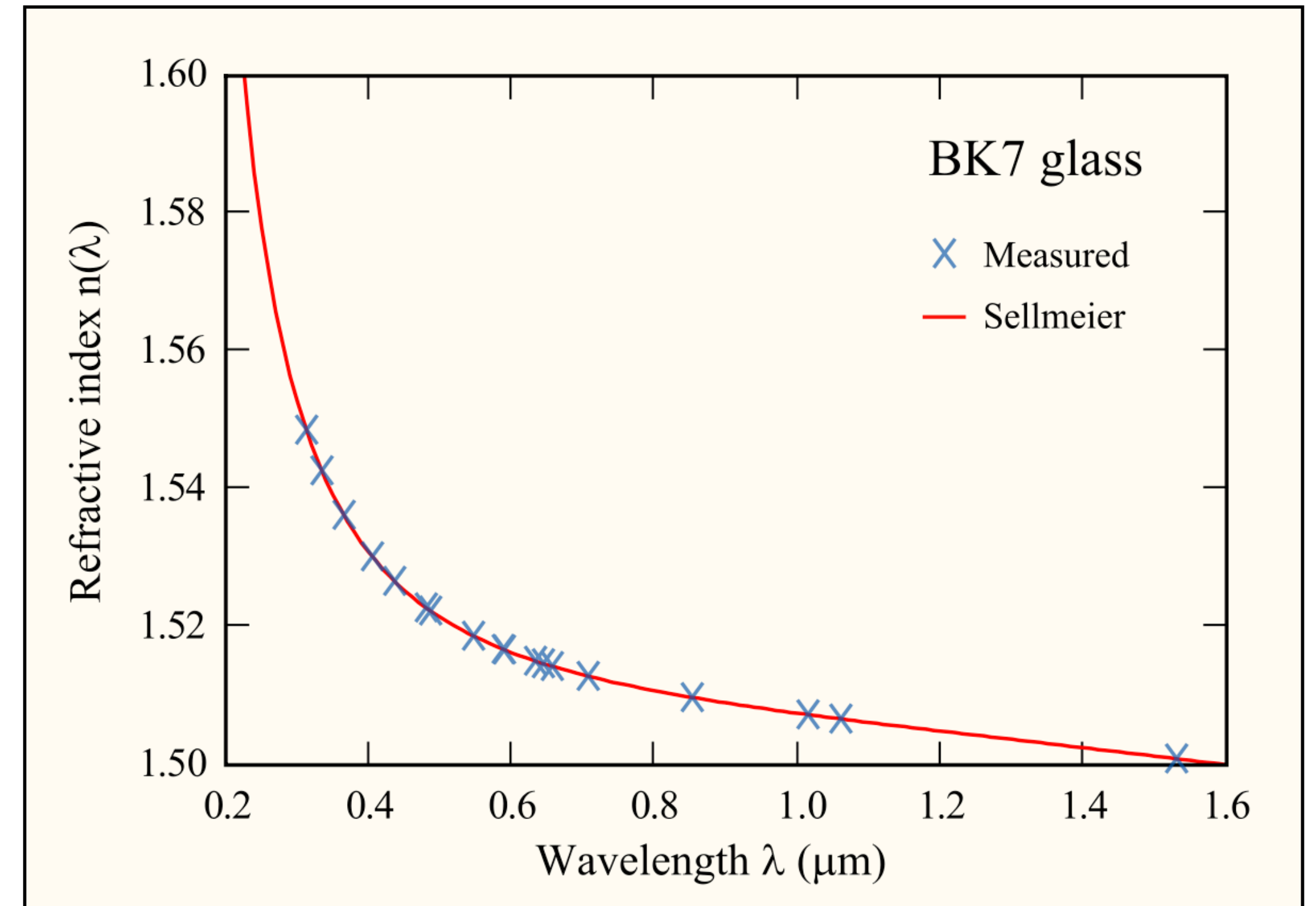
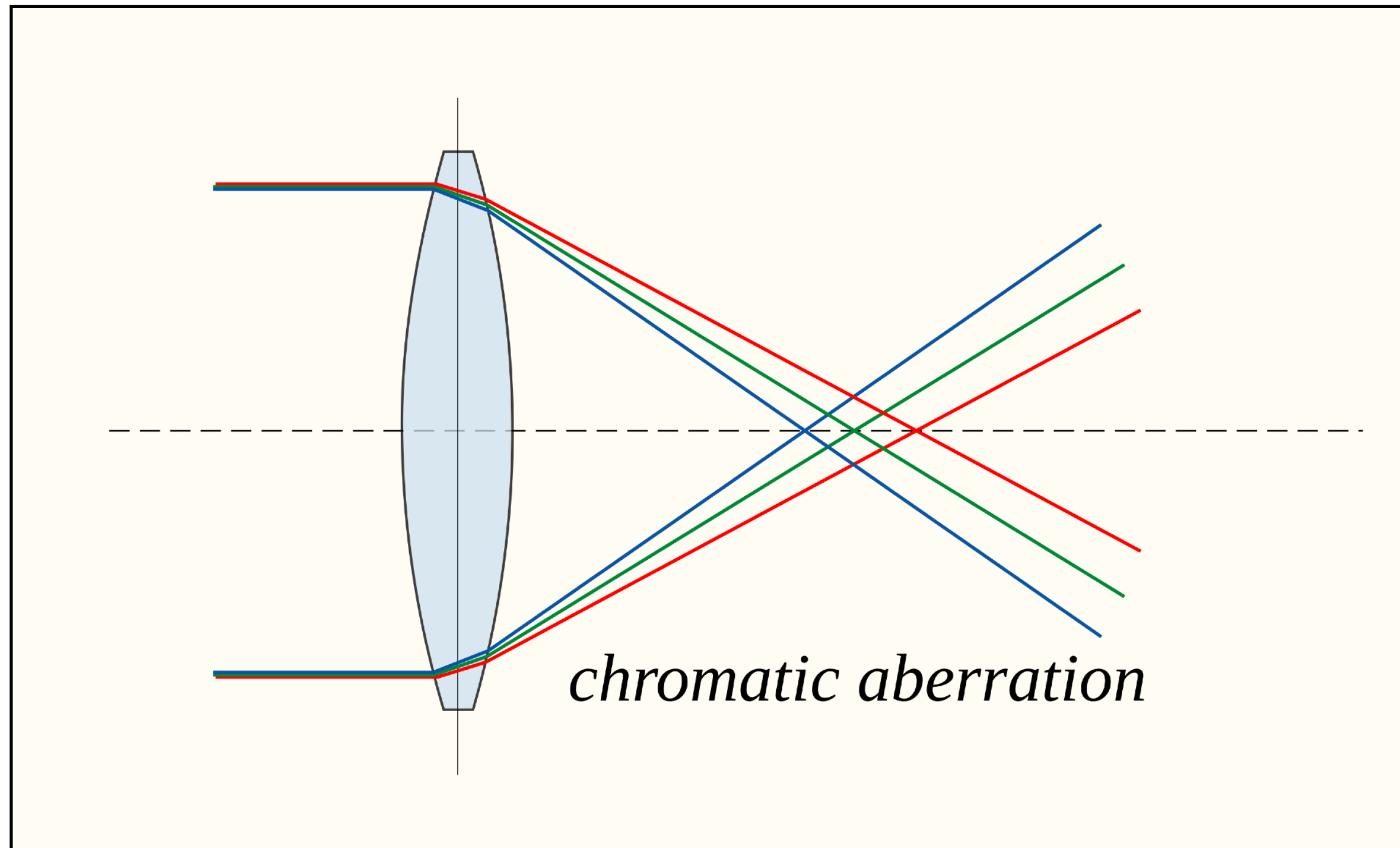

Figure 6.34 (a) Undistorted object. (b) When the magnification on the optical axis is less than the off-axis magnification, pincushion distortion results. (c) When it is greater on axis than off, barrel distortion results. (d) Pincushion distortion in a single thin lens. (e) Barrel distortion in a single thin lens. (E.H.)

Chromatic Aberration

Longer-wavelength lights have lower refractive indices



Chromatic Aberration

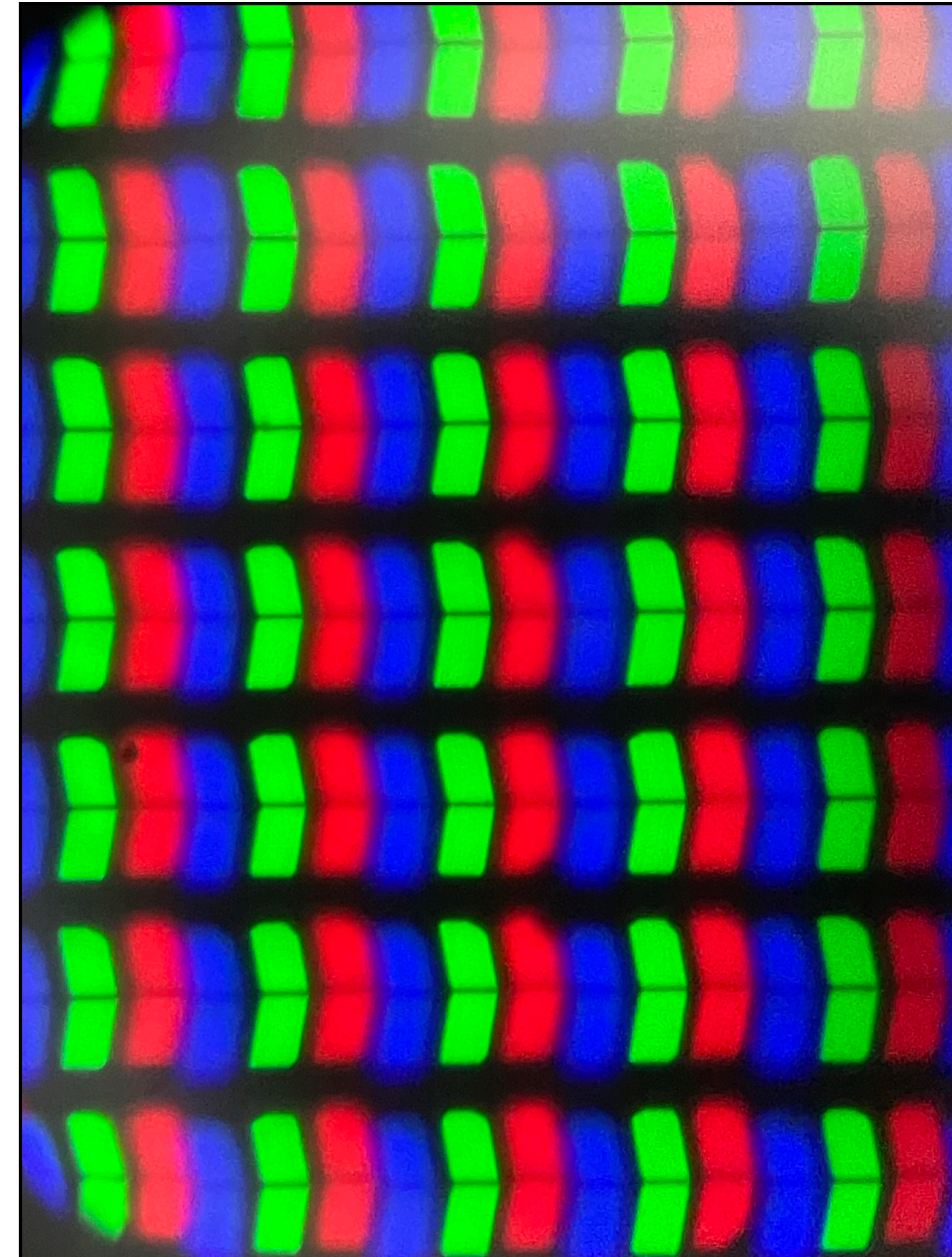
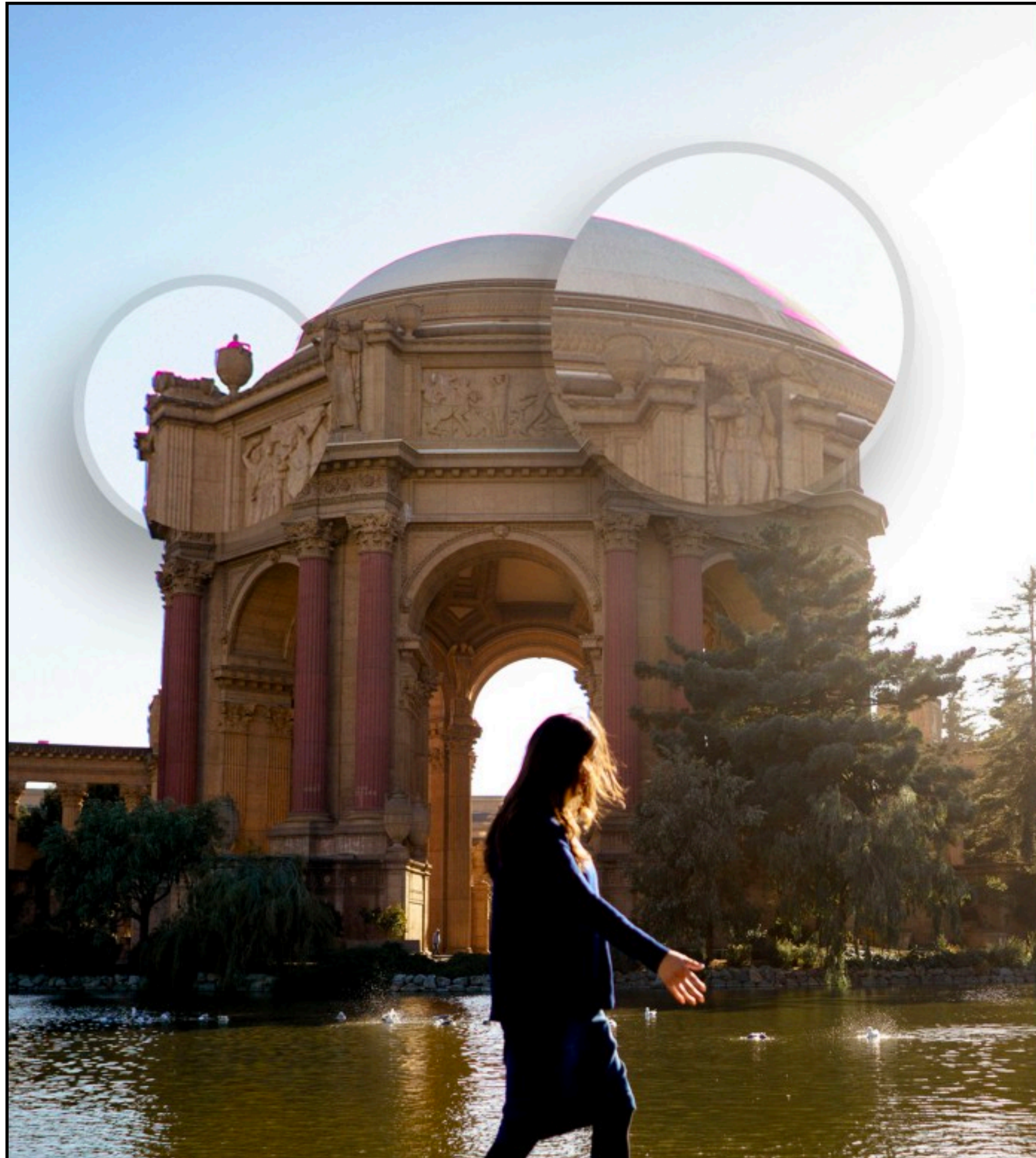

Fixing Chromatic Aberration: Achromatic doublets

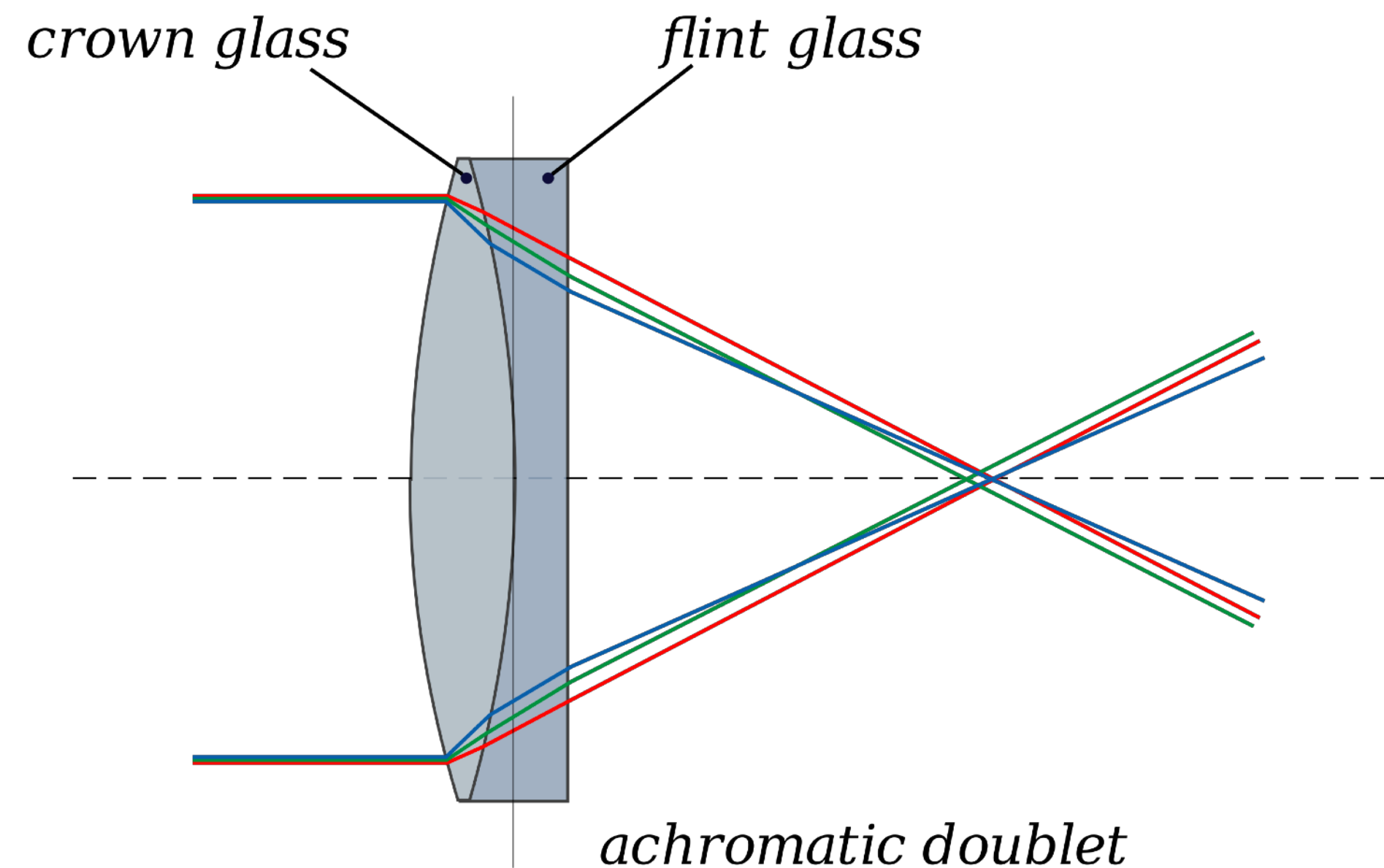

Crown (low refractive index, low dispersion)

Flint (high refractive index, high dispersion)

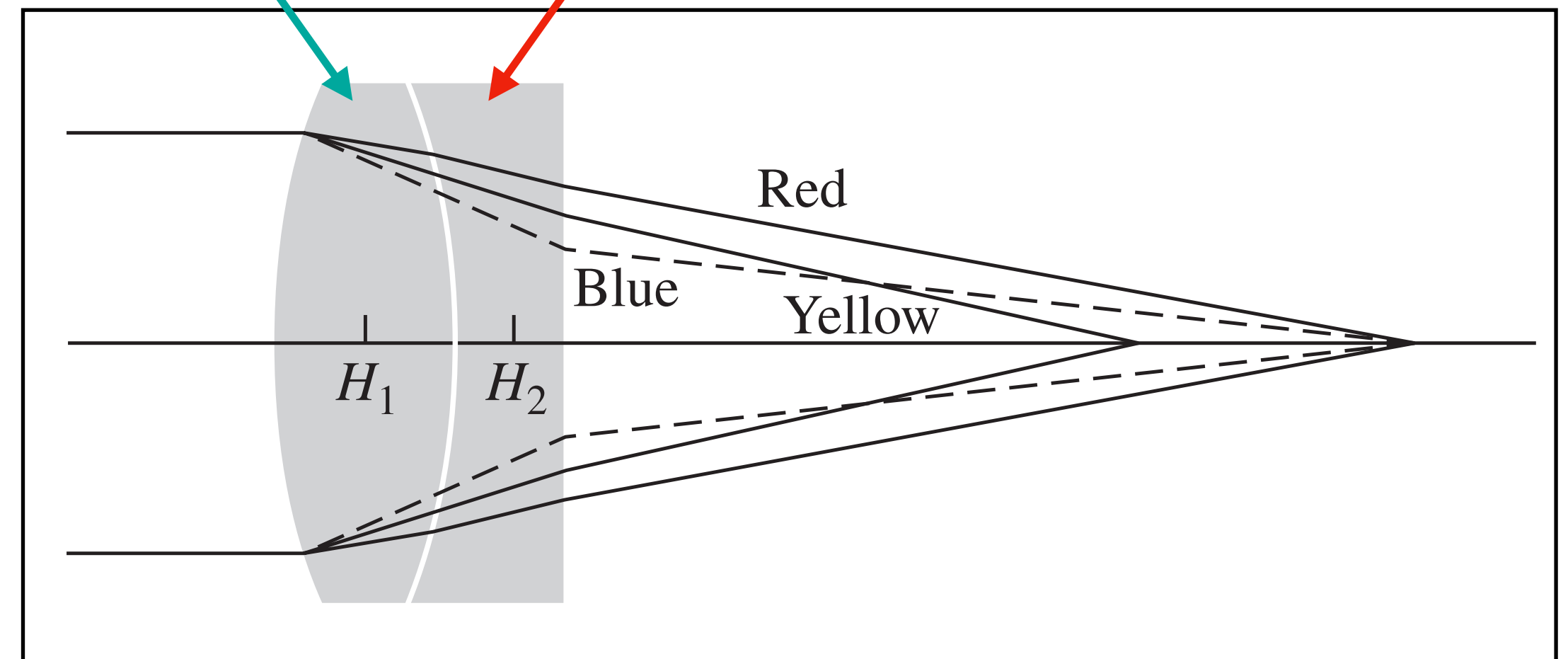

Depth of Field

Defocus Blur

If CoC is greater than a threshold, the point appears blur.

- Multiple pixels get some rays from that point
- Blur from defocus; c.f. motion blur

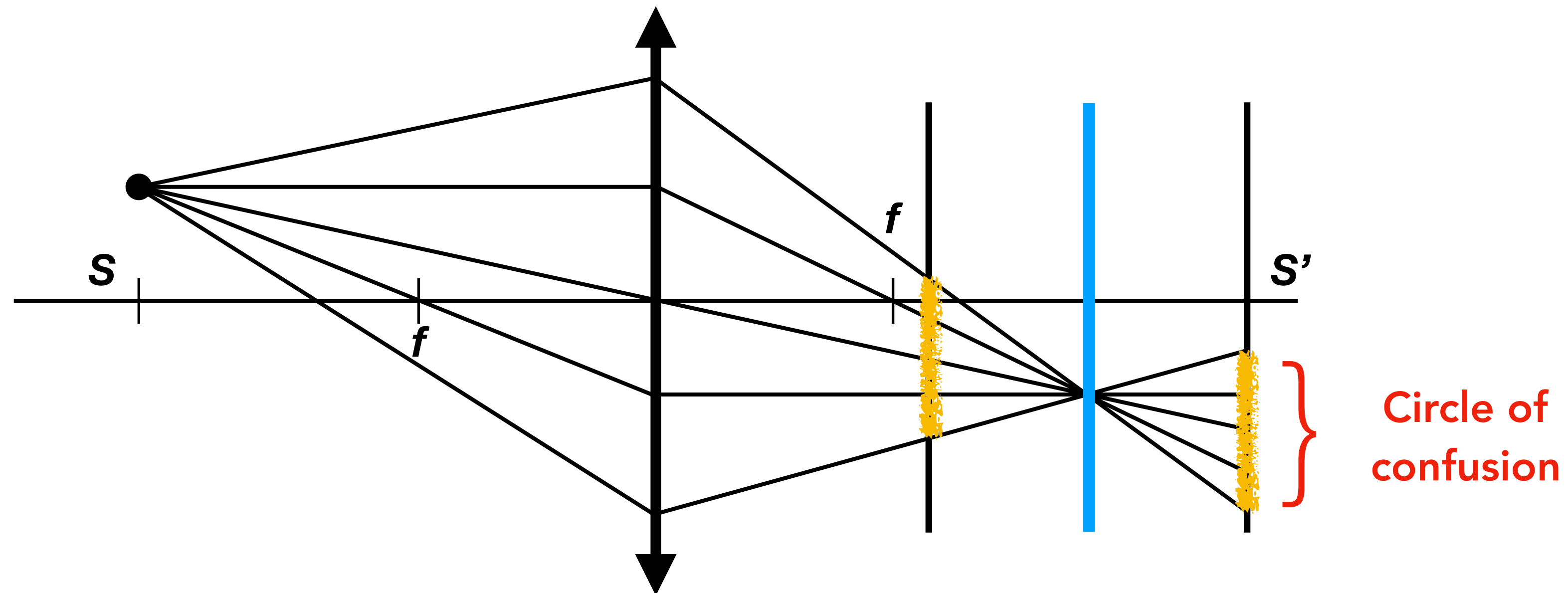

Bokeh

Bokeh is the size of an out-of-focus/defocused point.

Shape of bokeh is ~shape of the aperture.

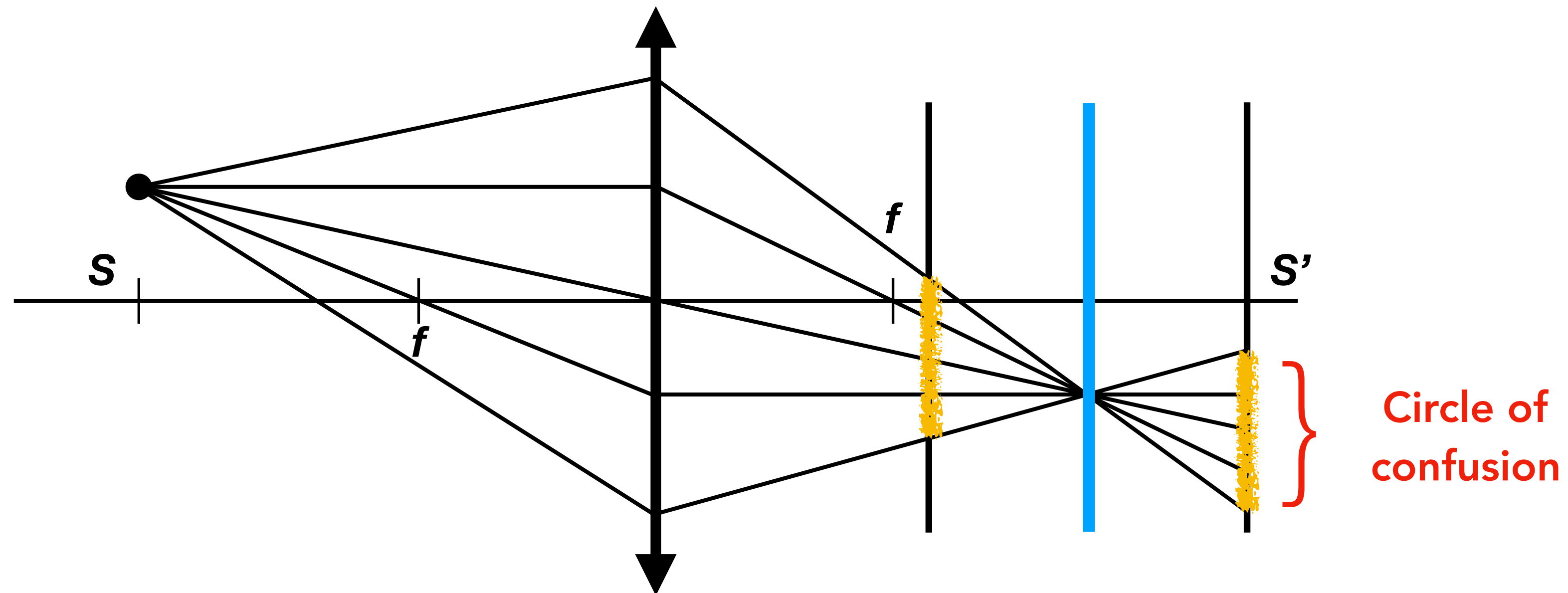





Depth of Field

Given that the sensor is focused on objects at distance T , what are the nearest and farthest scene points that will be in focus?

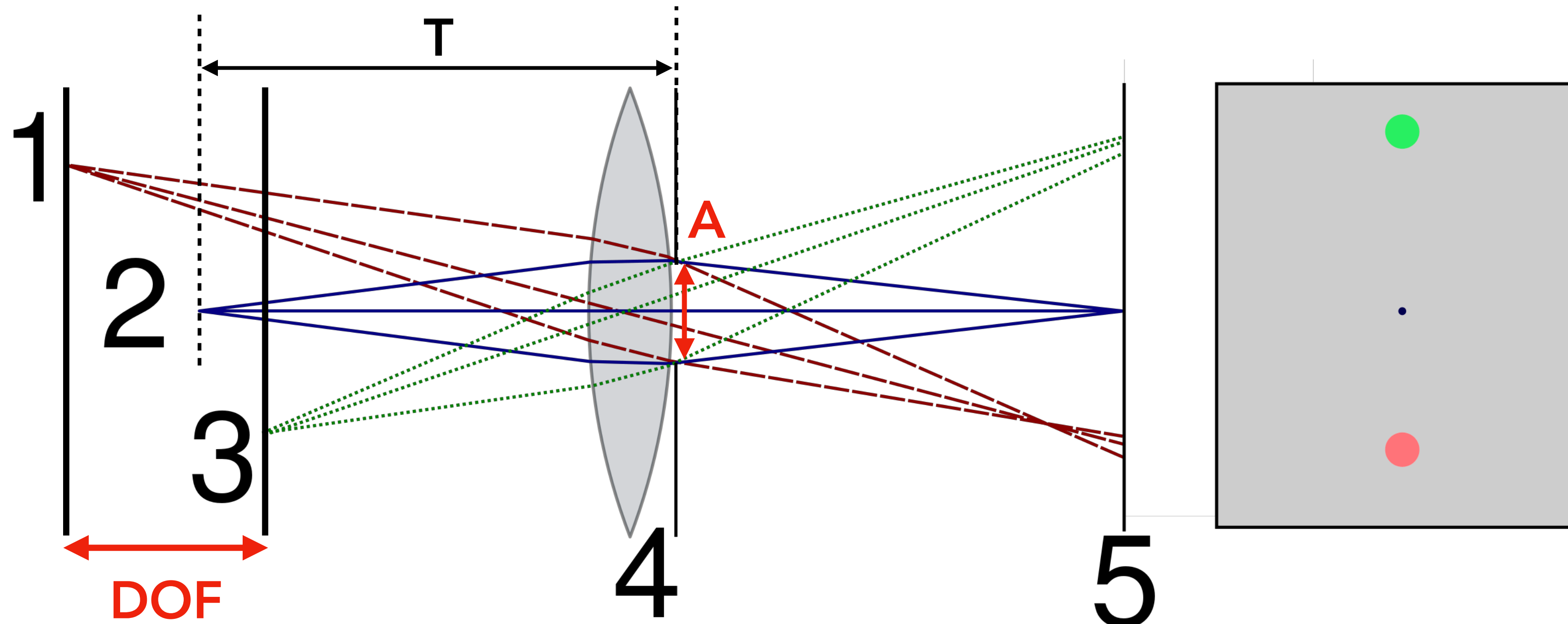

Depth of Field

$$DOF = \frac{2CT^2N}{f^2}$$

T: distance to object in focus

f: focal length

C: CoC threshold

N: F-number (f/A)

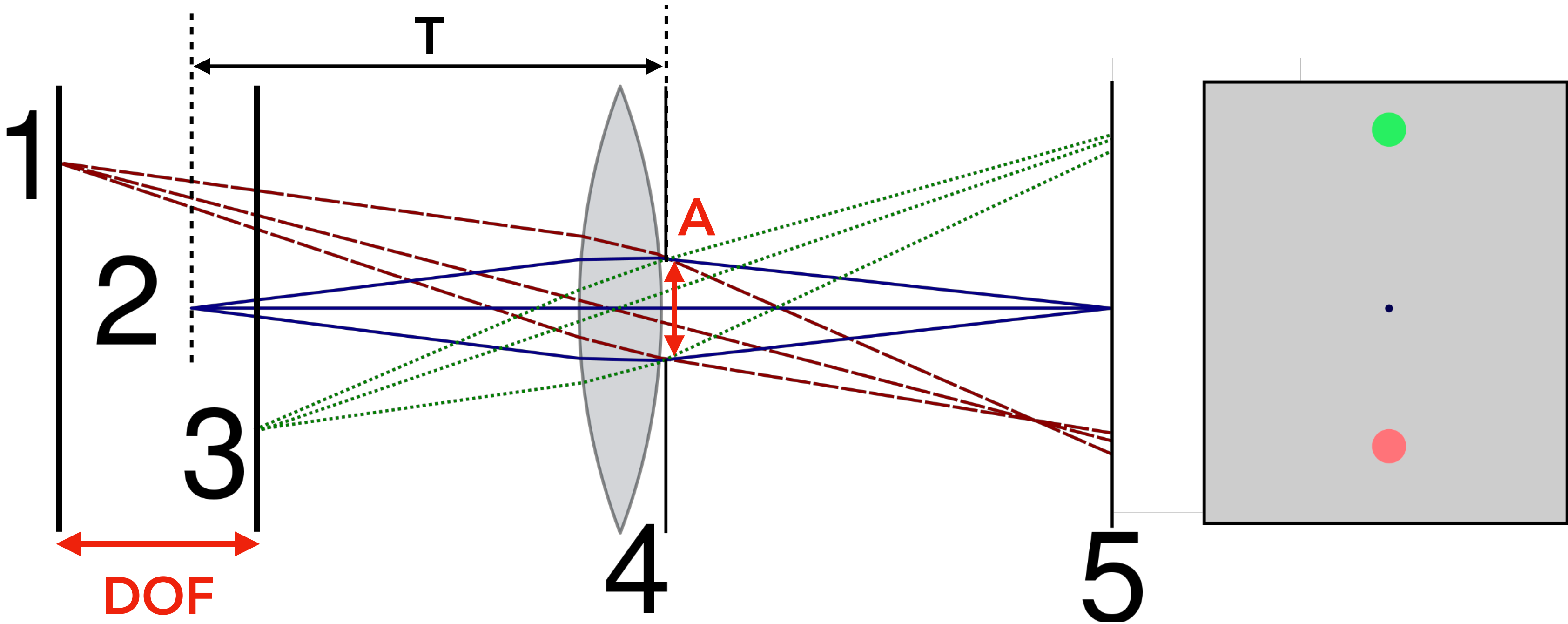

* Note: you can infer T from f and the lens-sensor distance given a camera, but from f alone we can't infer T.

F-Number



$$N = \frac{f}{A} = \frac{\text{focal length}}{\text{aperture size}}$$



Why F-Number is So-Defined?

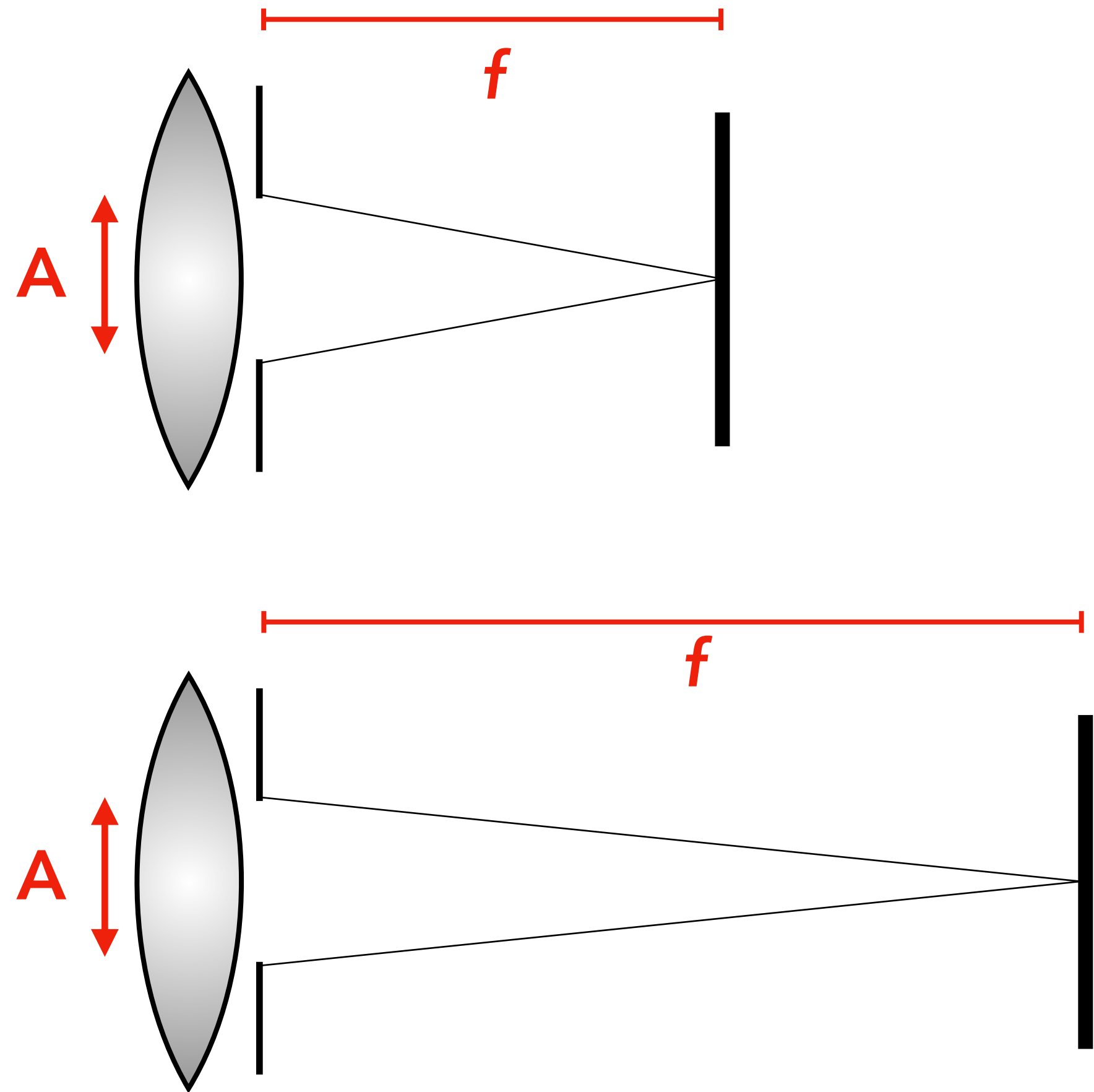

$$N = \frac{f}{A} = \frac{\text{focal length}}{\text{aperture size}}$$

The irradiance of a pixel (photons per area) is proportional to:

- 1. square of aperture size A (the amount of photons that are allowed through)
- 2. inverse square of the focal length (remember irradiance falls off quadratically with distance)
- So pixel irradiance $\sim 1/N^2$

How to Increase DOF?

$$DOF = \frac{2CT^2N}{f^2}$$

T: distance to object in focus

f: focal length

C: CoC threshold

N: F-number (f/A)

1. Focus on farther away (e.g., landscape)

A large T



A small T



How to Increase DOF?

$$DOF = \frac{2CT^2N}{f^2}$$

T: distance to object in focus

f: focal length

C: CoC threshold

N: F-number (f/A)

1. Increase T: focus on farther away (e.g., landscape)
2. Reduce A: use a large F-number (smaller aperture)

Small Aperture Increases DOF

A ↓ ; F-Number ↑ ; DOF ↑

f/1.4; DOF = 0.8 cm



f/4.0; DOF = 2.2 cm



f/22; DOF = 12.4 cm



f 2.8



f 4



f 5.6



f 8



f 11



f 16



f 22



f/16



f/4



f/1.4

Motion Blur vs. DOF Trade-off

A small aperture increases the exposure time and motion blur.

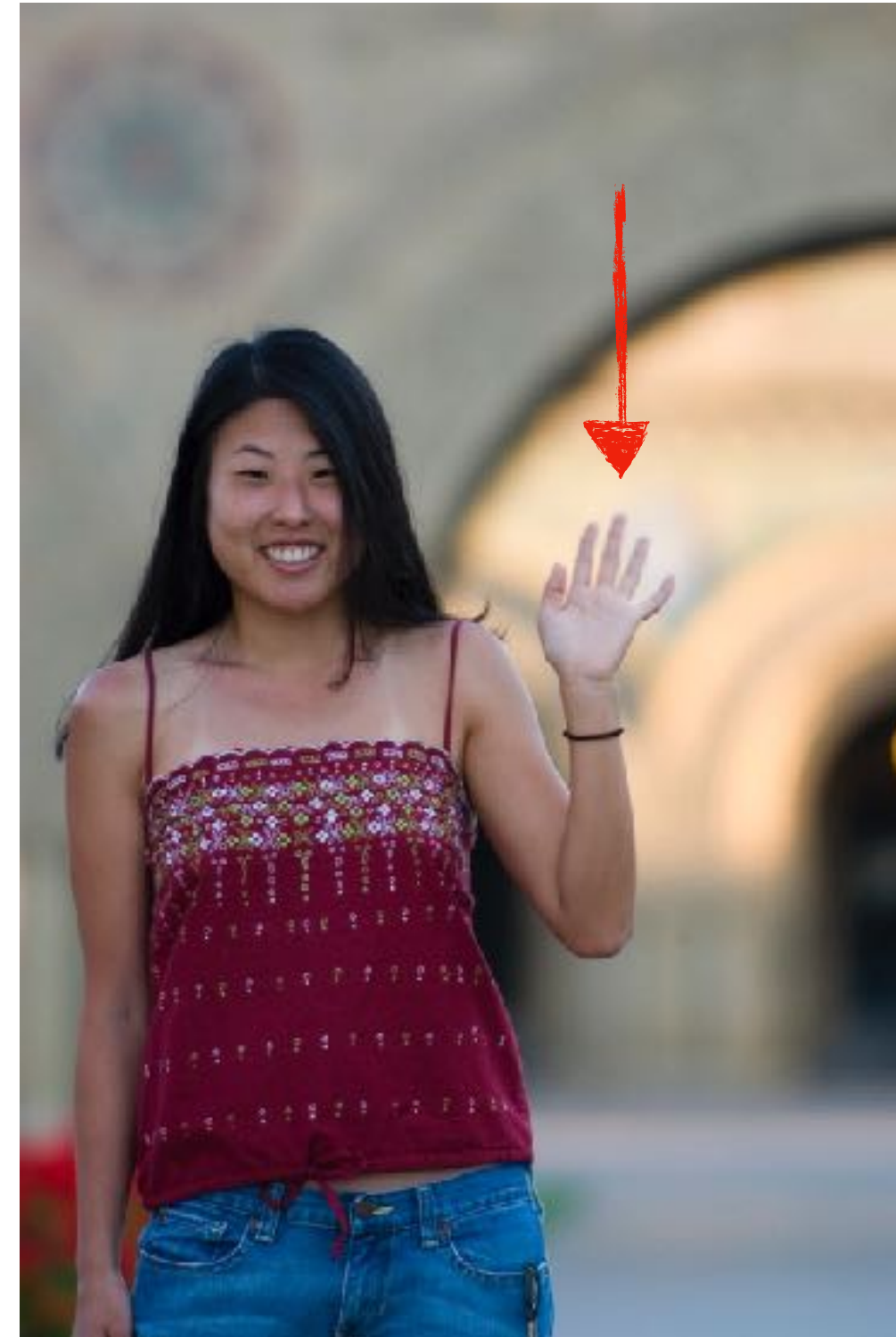

f / 4
1/125 sec

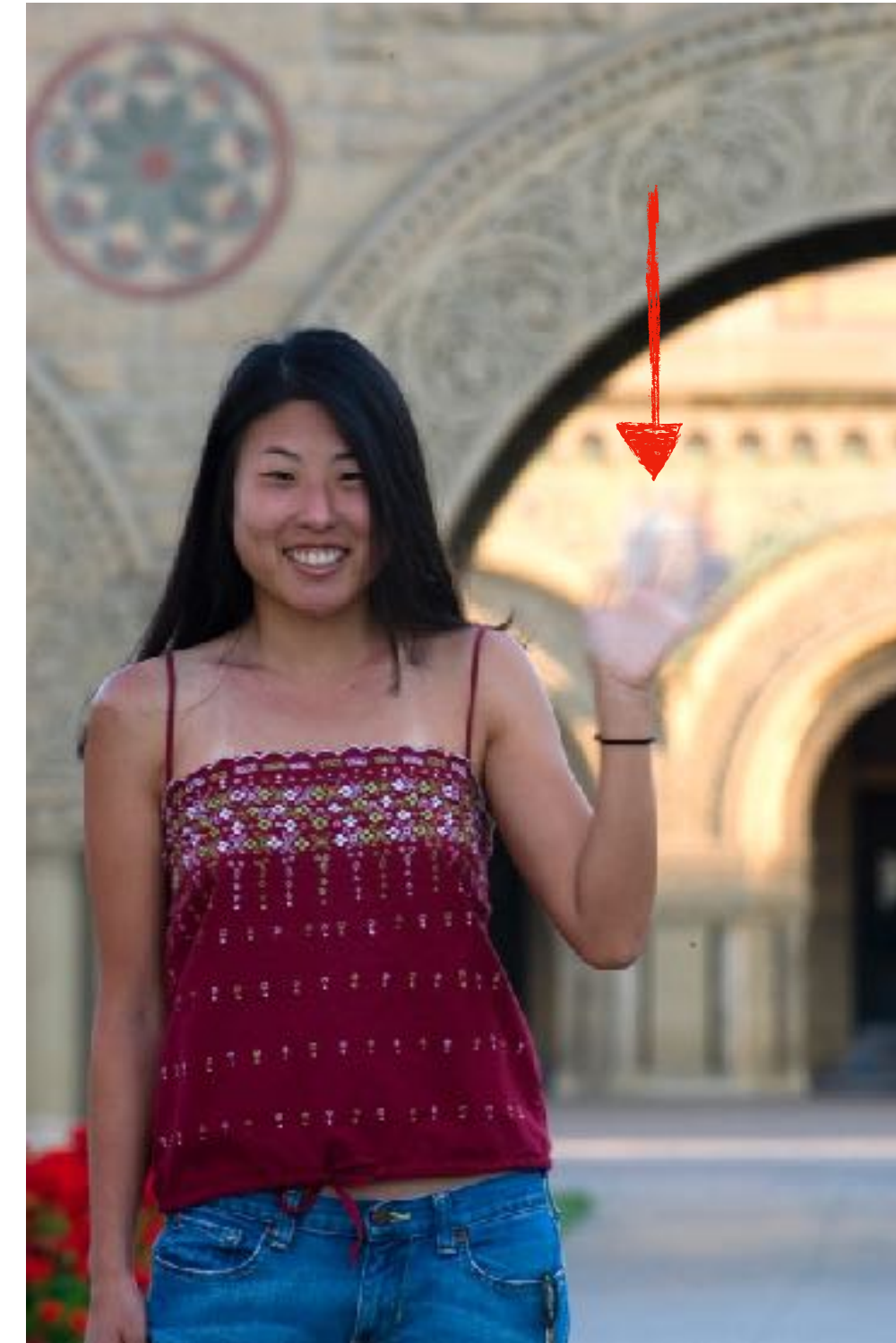

f / 11
1/15 sec

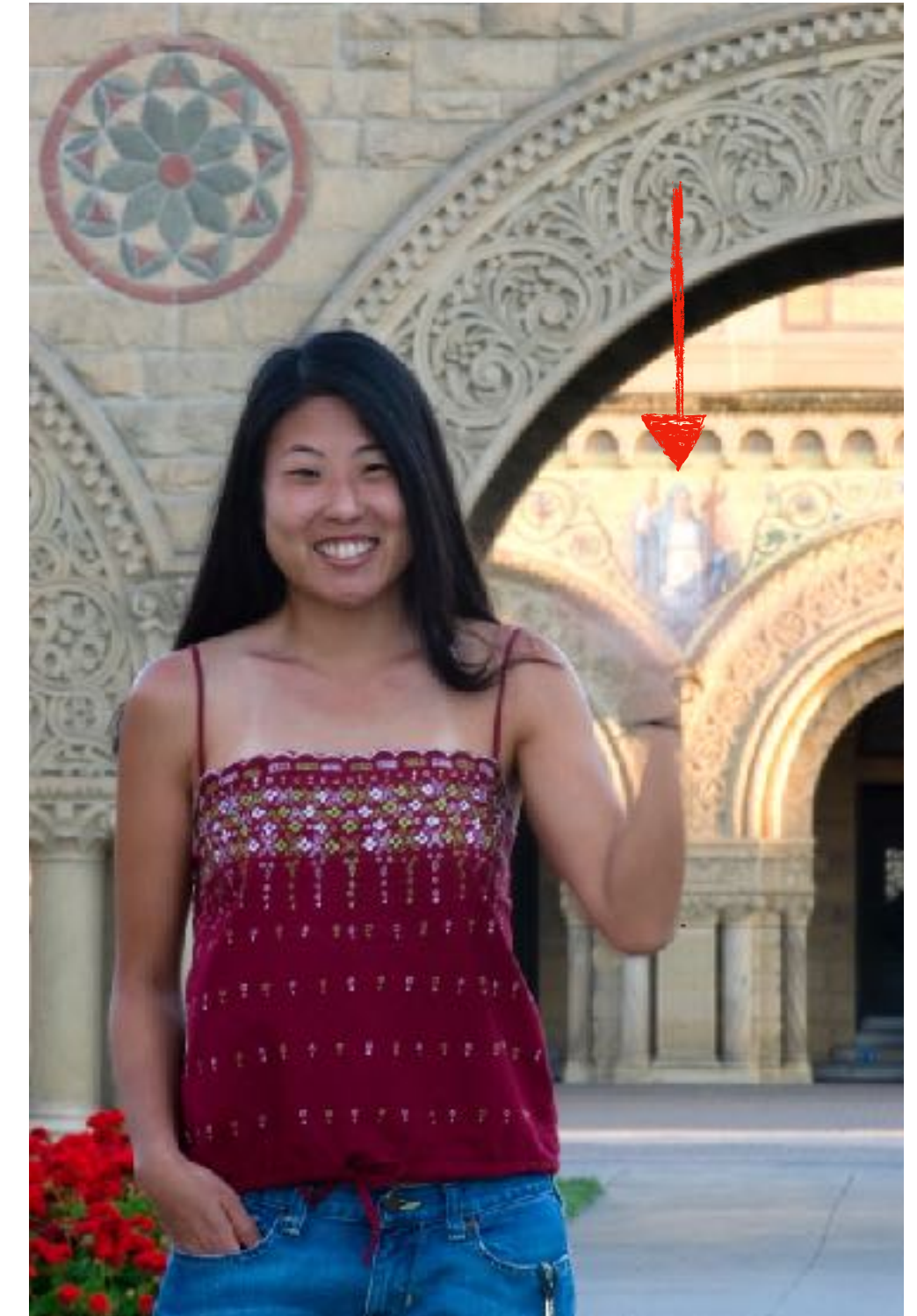

f / 32
1/2 sec

Large Apertures for Small DOFs

Large DOF is not always desirable

- Portrait photography needs a small (shallow) DOF, which requires a large aperture.

Smartphone cameras can't have a large aperture. Computational photography to the rescue

- "synthesis depth of field"



Synthetic Depth of Field

Shot an all-in-focus photo



Estimate pixel depths



Blur background pixels



Google Pixel 2

DOF of a Pinhole Camera

A pinhole camera effectively has an infinite depth of field.

- Ideal pinhole camera is a special camera with an infinitesimal aperture.
- Everything is in-focus; each point has only one ray reaching the sensor — unless the pinhole size is large.

$$DOF = \frac{2CT^2N}{f^2}$$

$$N = \frac{f}{A}$$



How to Increase DOF?

$$DOF = \frac{2CT^2N}{f^2}$$

T: distance to object in focus

f: focal length

C: CoC threshold

N: F-number (f/A)

1. Increase T: focus on farther away (e.g., landscape)
2. Reduce A: use a large F-number (smaller aperture)
 - Affects exposure time (motion blur)
3. Decrease f: shorter focal length
 - Just remember that f affects magnification and field of view too.

Making Use of Blur

Motion Blur vs. Defocused Blur



Infer Speed from Motion Blur

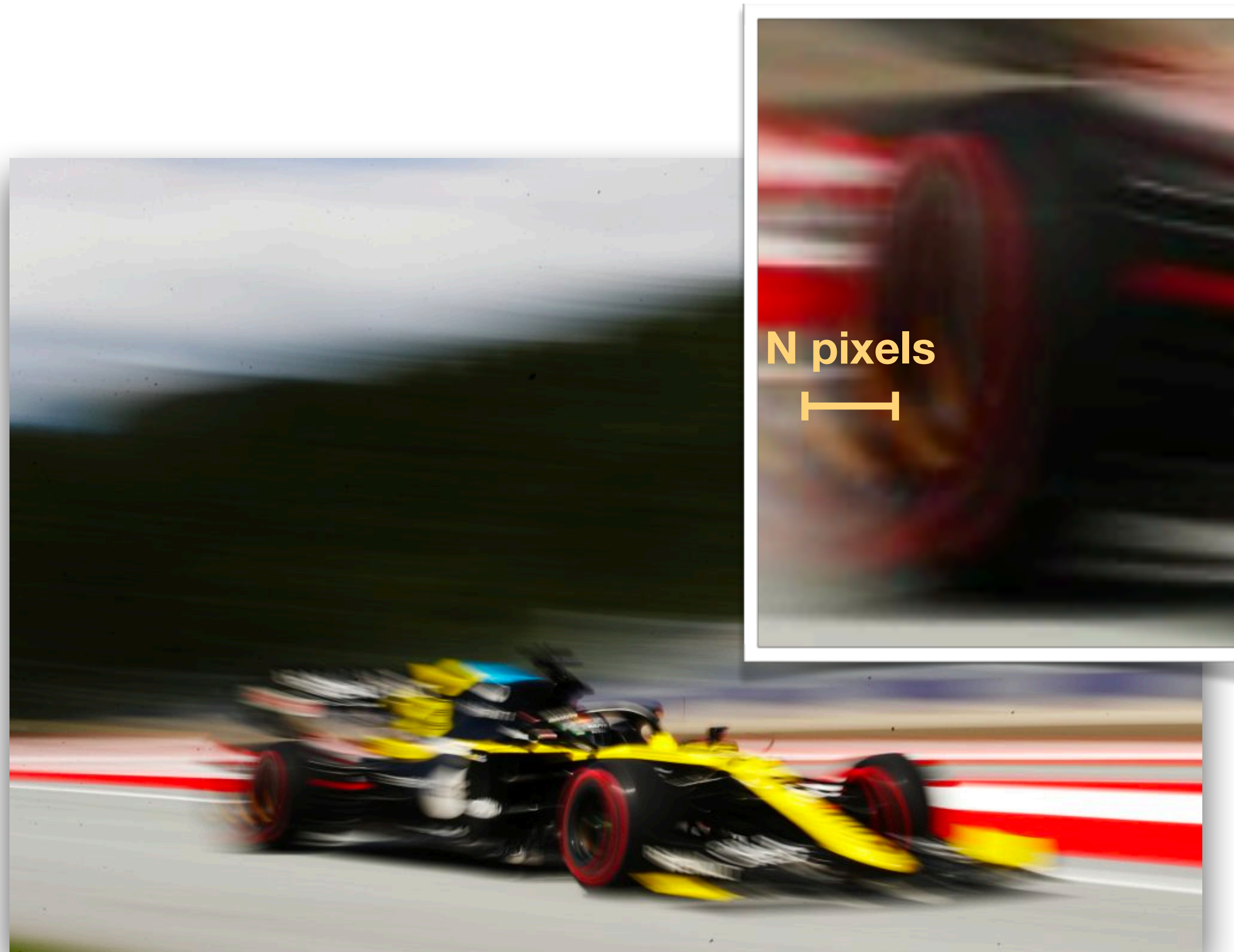

1. Translate # of pixels to distance on the sensor using pixel size.
2. Translate the distance on sensor to the distance in the scene (depends on the scene depth).
3. Use exposure time to estimate the object speed.

Motion from Blur Challenges

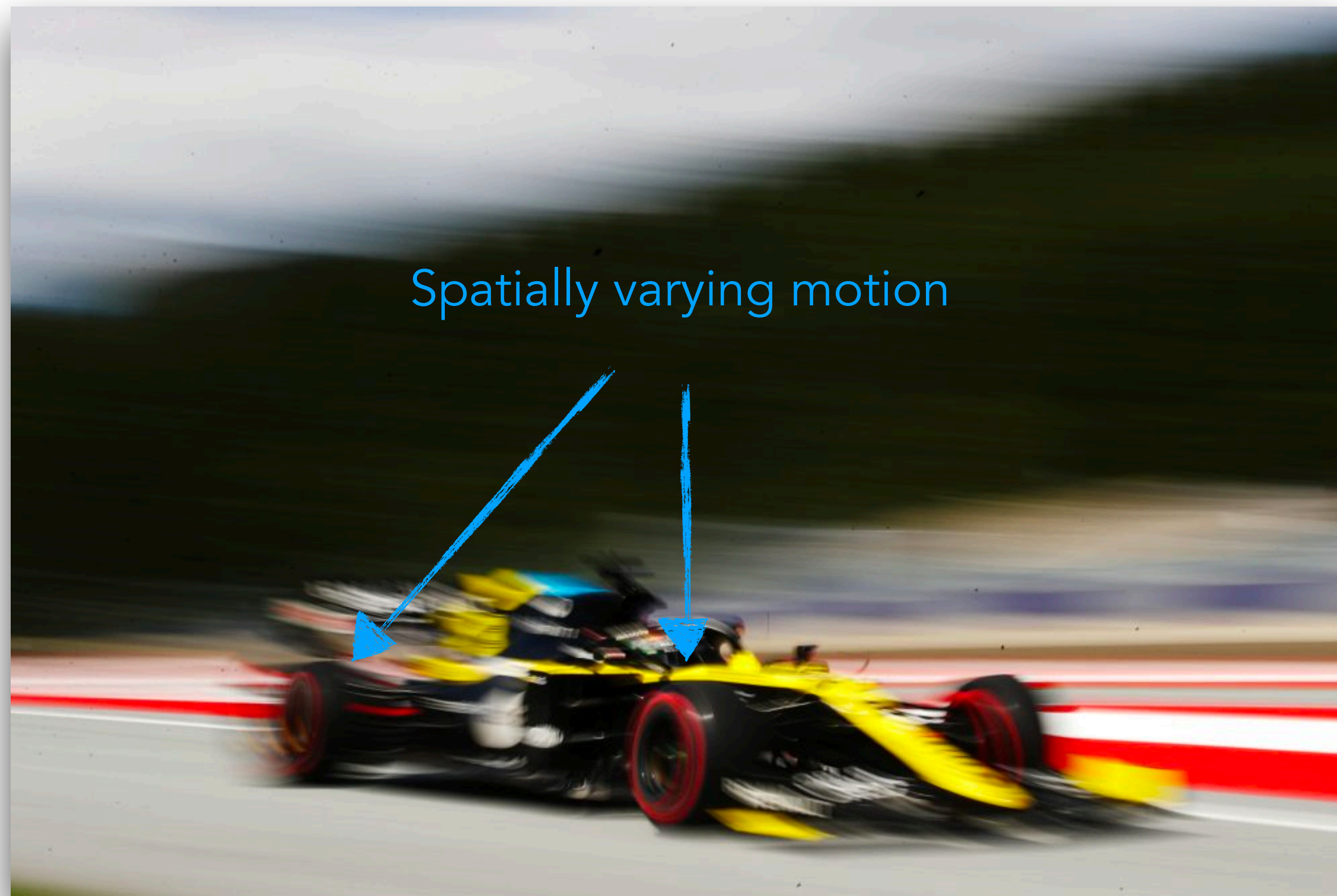

Non-linear motion

Depth From Defocused Blur

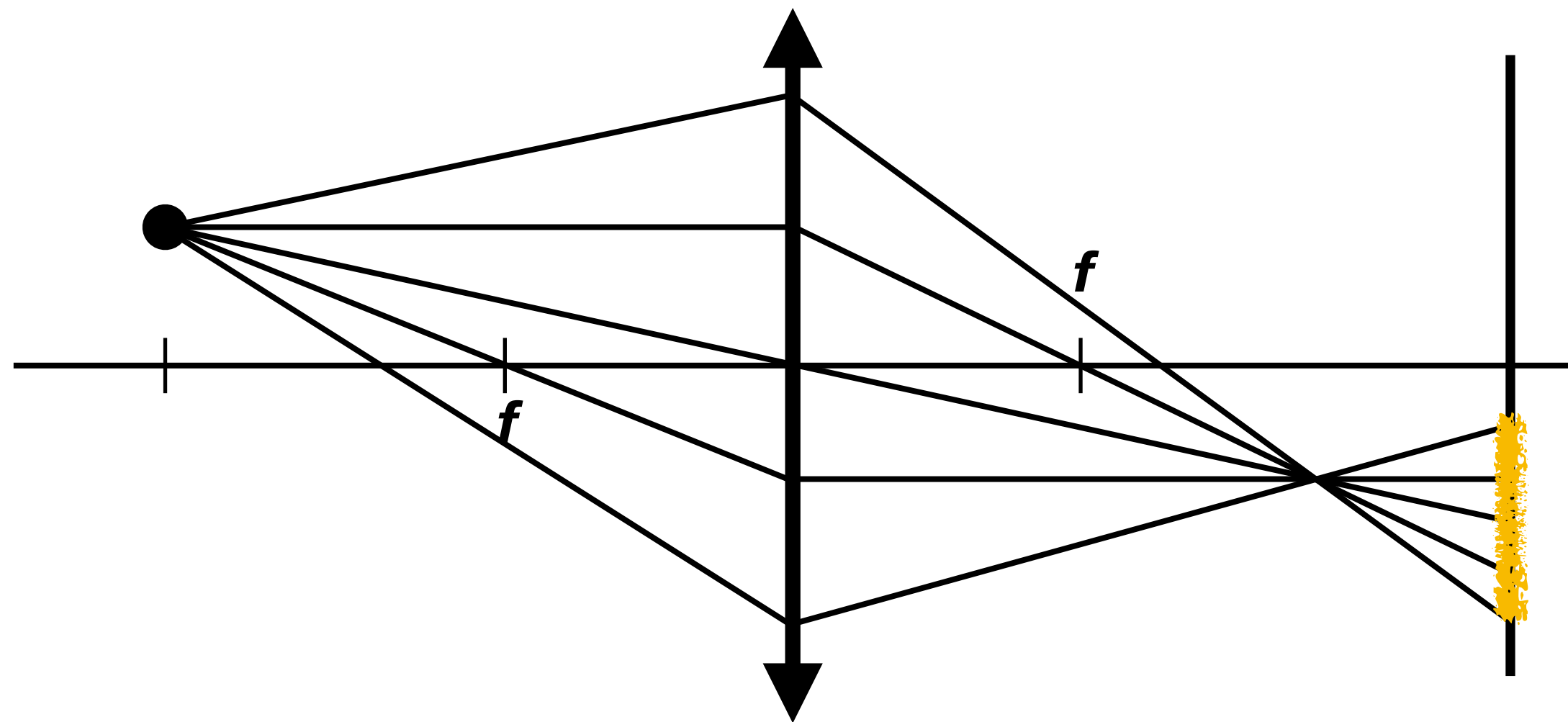

Scene depth is proportional to the CoC size.



Depth From Defocus Challenges

CoCs of Point 1 and Point 3 are the same, but they have different depth.

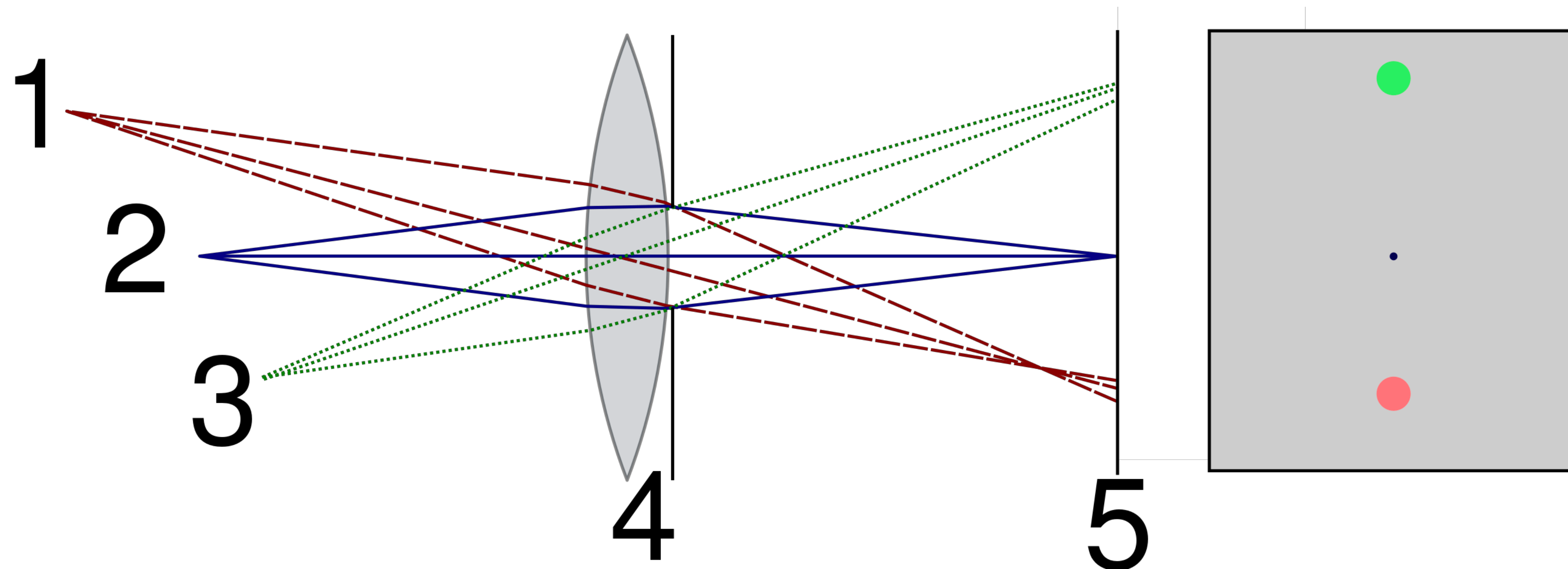

Defocus of general lens

Slide credit: Vivek Boominathan

Circular lens aperture

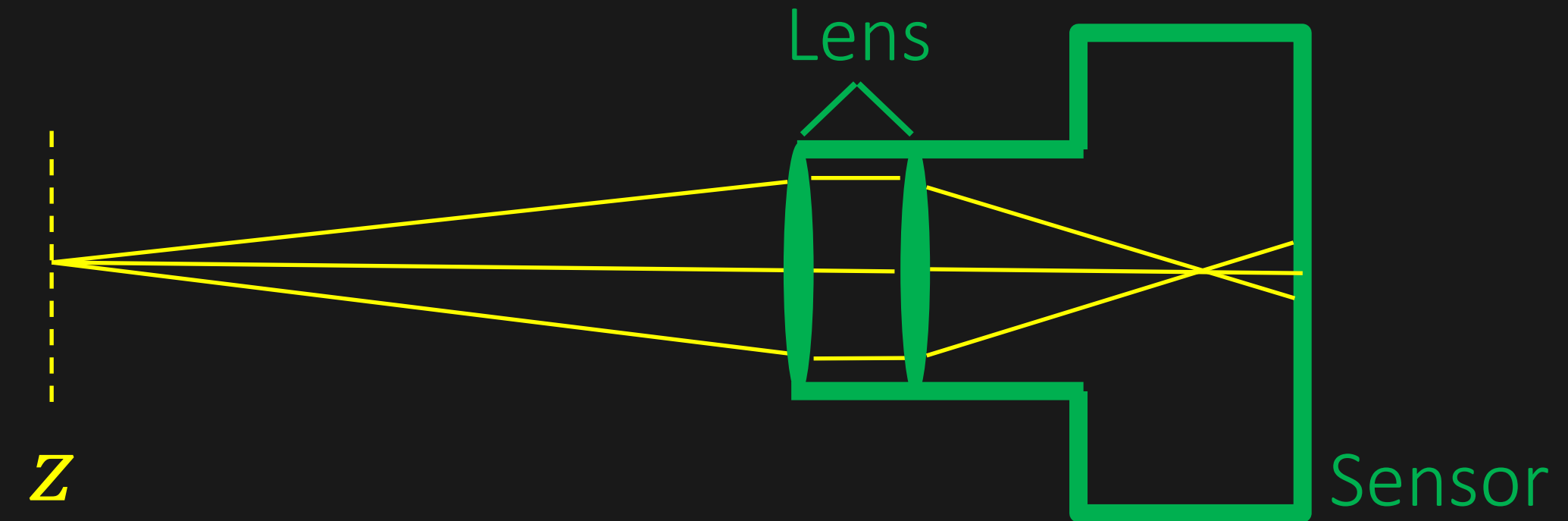

PSFs at different depths

Far



Focus



Near

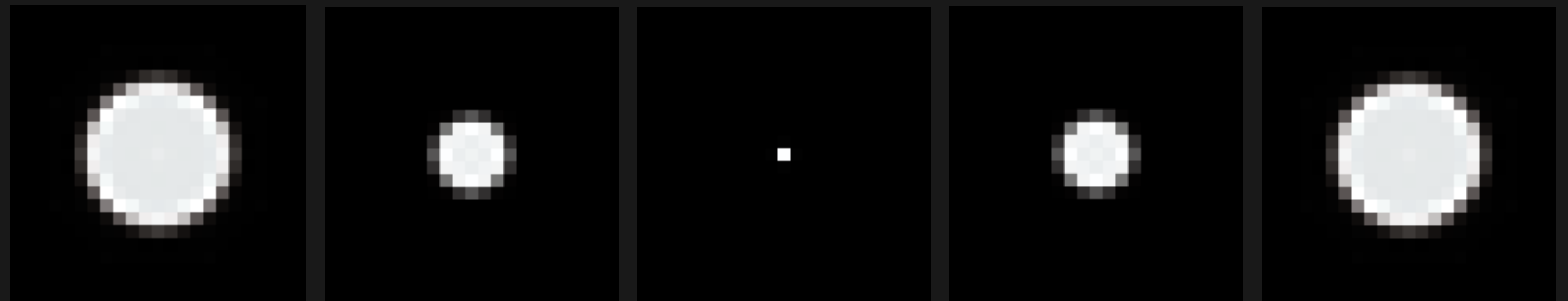

- × Identical PSF at both sides of the focal plane.
- × Impossible to tell the depth based on the blur size.

Independent-crafted designs

Slide credit: Vivek Boominathan

Veeraraghavan *et al.*, 2007

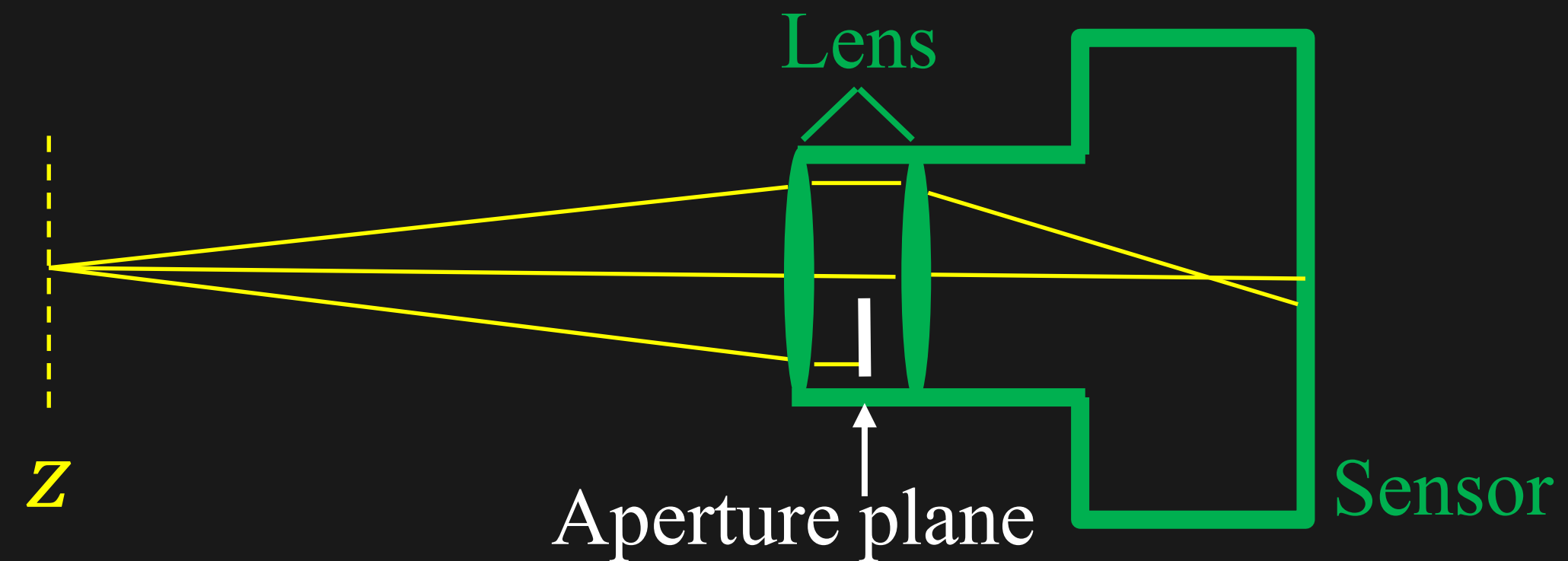

Levin *et al.*, 2007
(previously discussed)

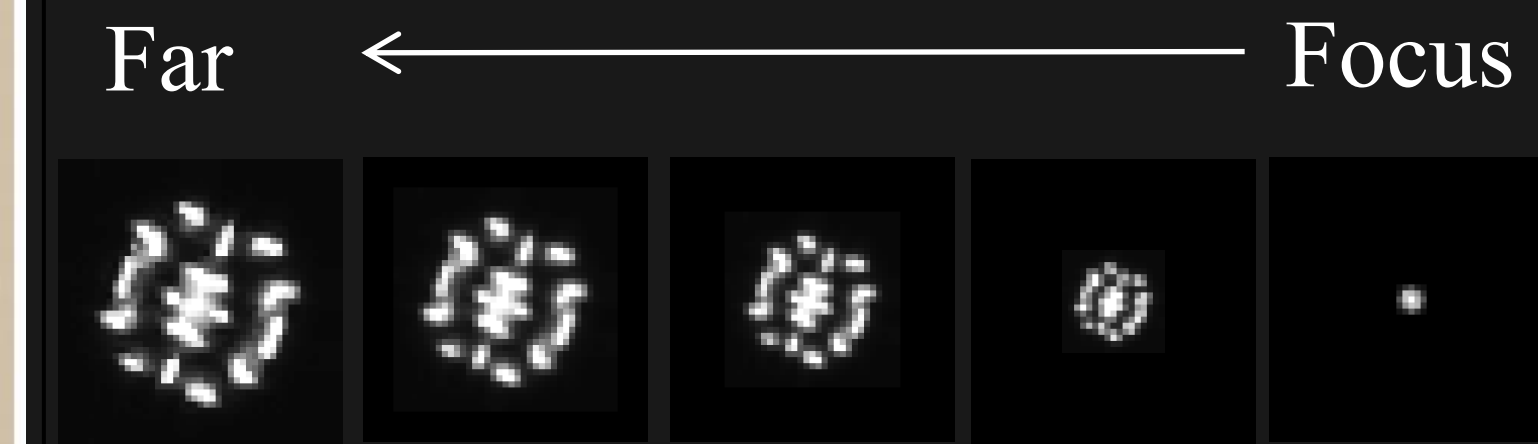
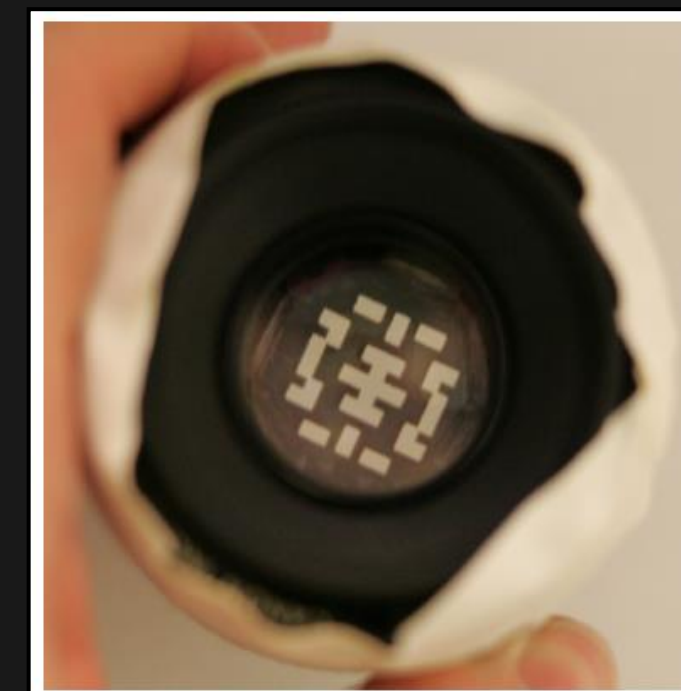
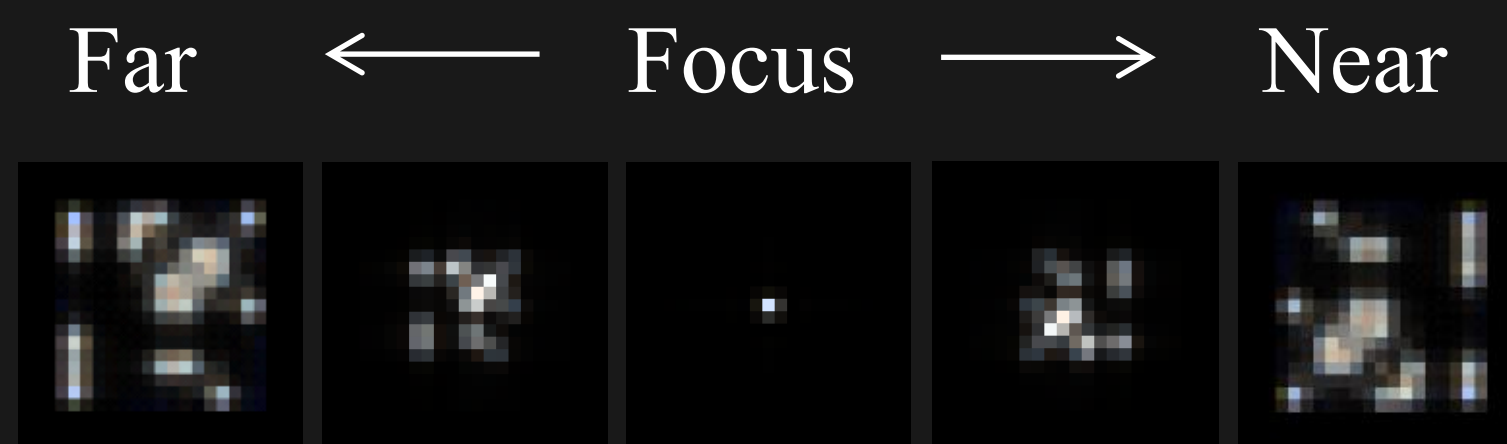
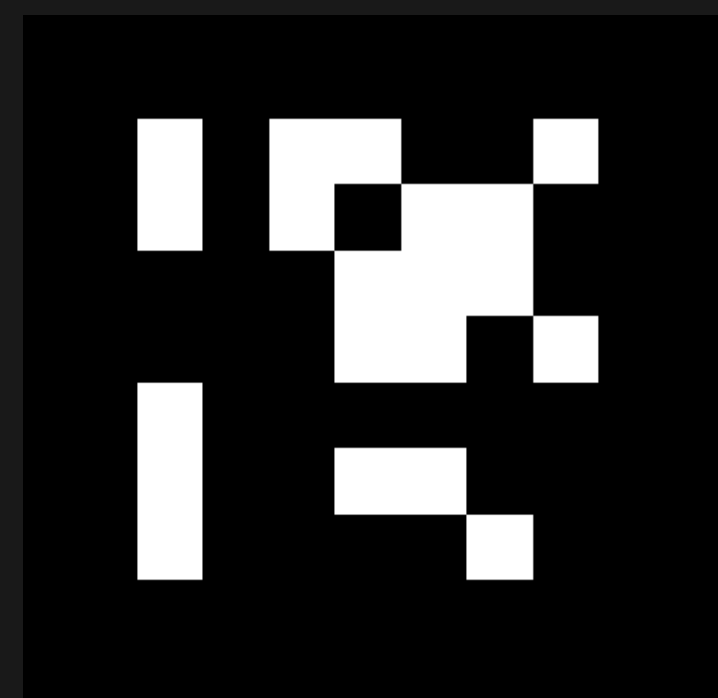
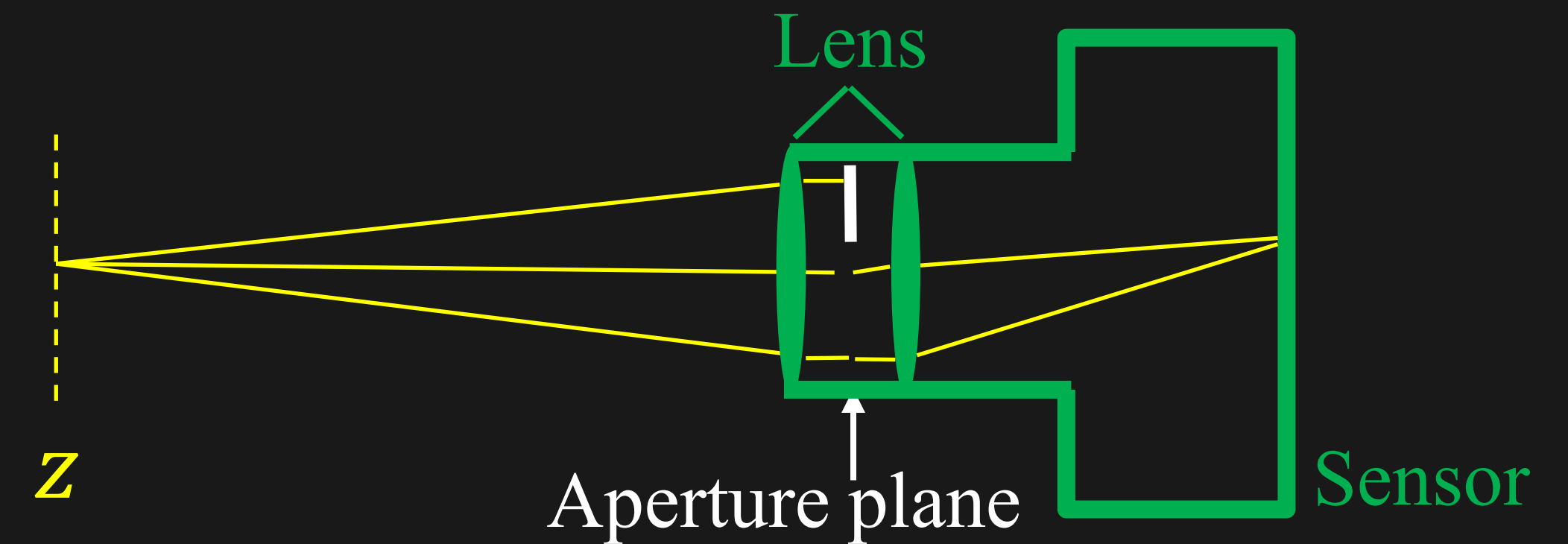

× The difference in PSFs across depth is only in scale.

PhaseCam3D sensor – Three upgrades

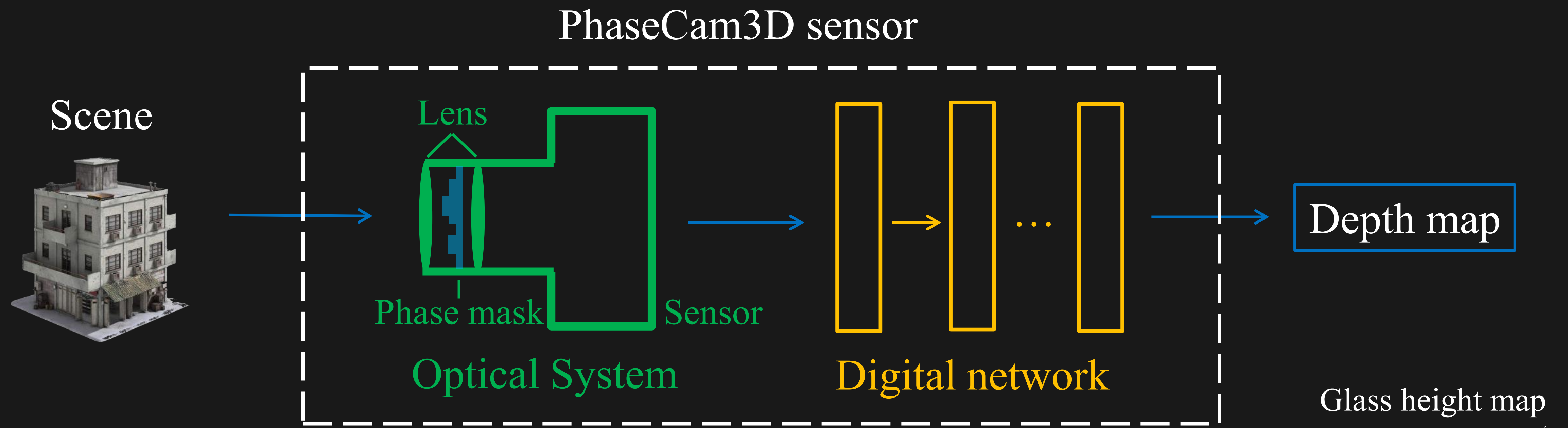

- Phase-coded aperture → More light. More control in PSFs.
- Digital network → Better for reconstruction.
- End-to-end learning → Joint learning.

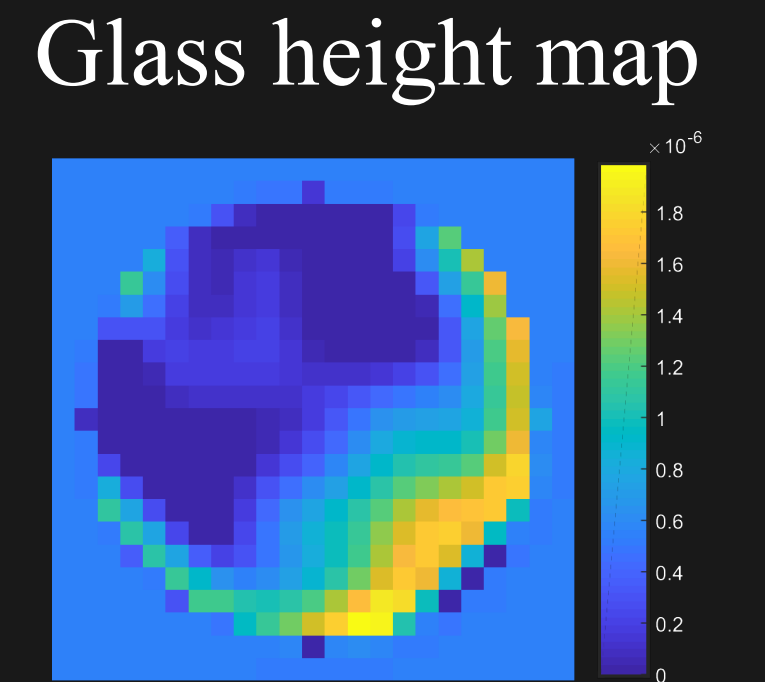

Fabricate the learned phase mask

Slide credit: Vivek Boominathan

Phase mask
glass height map

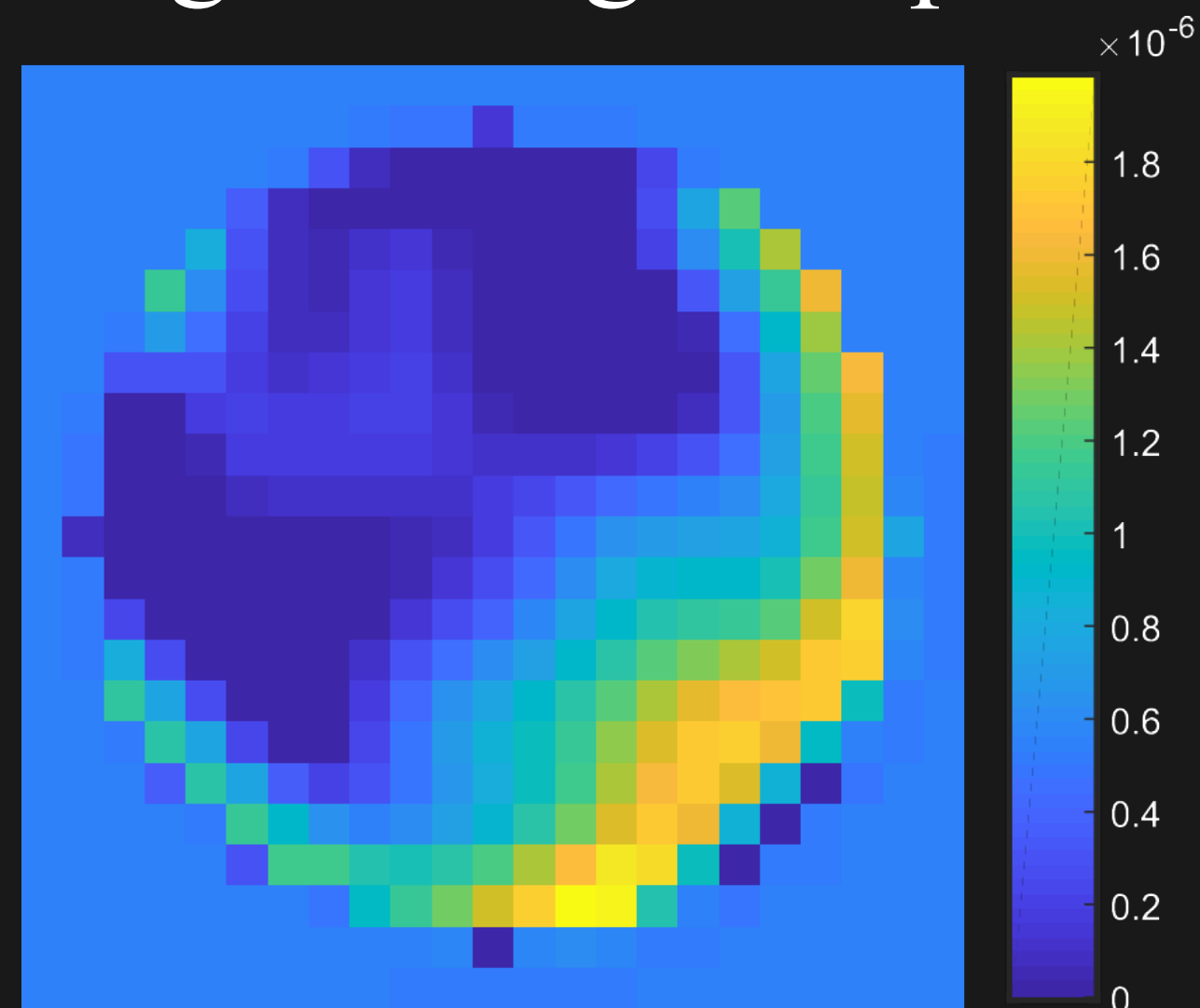

Fabricated phase mask

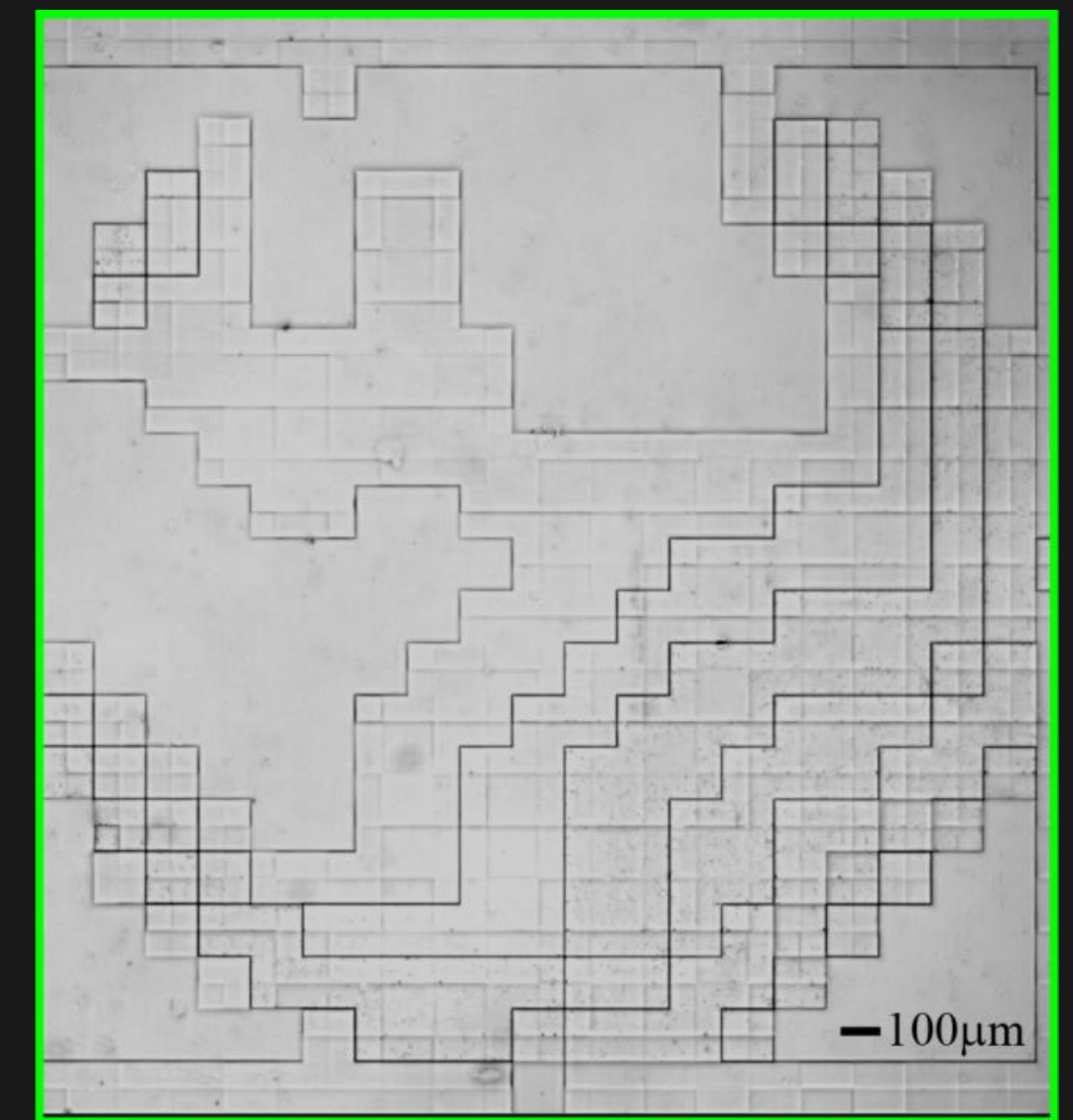

2.835 mm