

# Lecture 11: Displays and Lighting Systems

---

**Yuhao Zhu**

<http://yuhaozhu.com>  
[yzhu@rochester.edu](mailto:yzhu@rochester.edu)

CSC 259/459, Fall 2024  
Computer Imaging & Graphics

# The Roadmap

Theoretical Preliminaries

**Human Visual Systems**

Digital Camera Imaging

Modeling and Rendering

The Remaining Cool Things



Introduction and Overview

Photoreceptors

Color Vision and Colorimetry

Color Vision Deficiency

**Color Production**

Visual Adaptations

# Display vs. Lighting

# Apparent Color vs. Spectrum

The two lights have similar  
apparent color, but are  
they the same light?

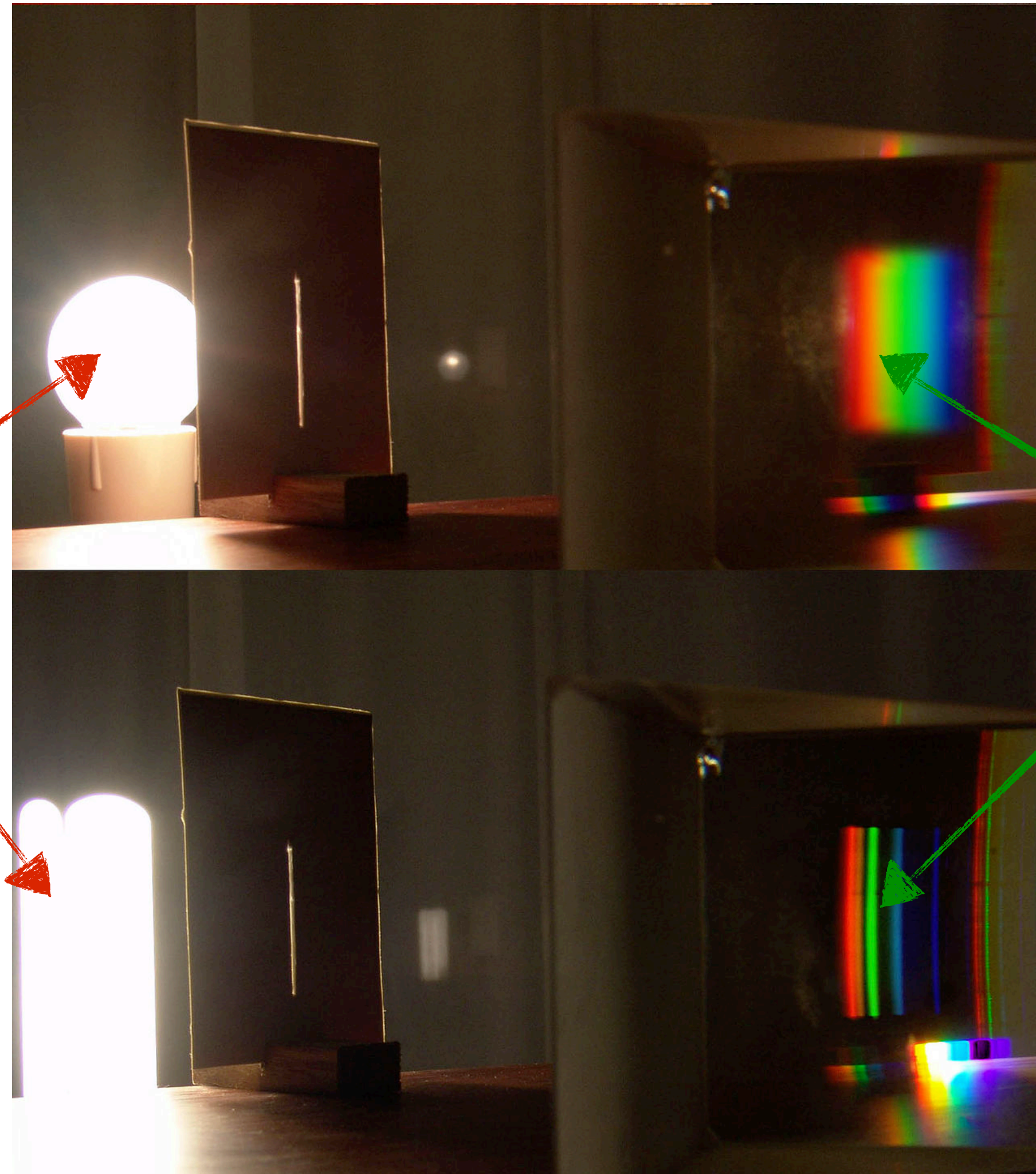

No! Lights with the  
same apparent color  
could have very  
different spectra.

# Do Spectra Ever Matter?

Assuming these two lights are metamers, which one is better at “revealing the color” of the object with the given spectral reflectance?

Reflectance spectrum  
of the object

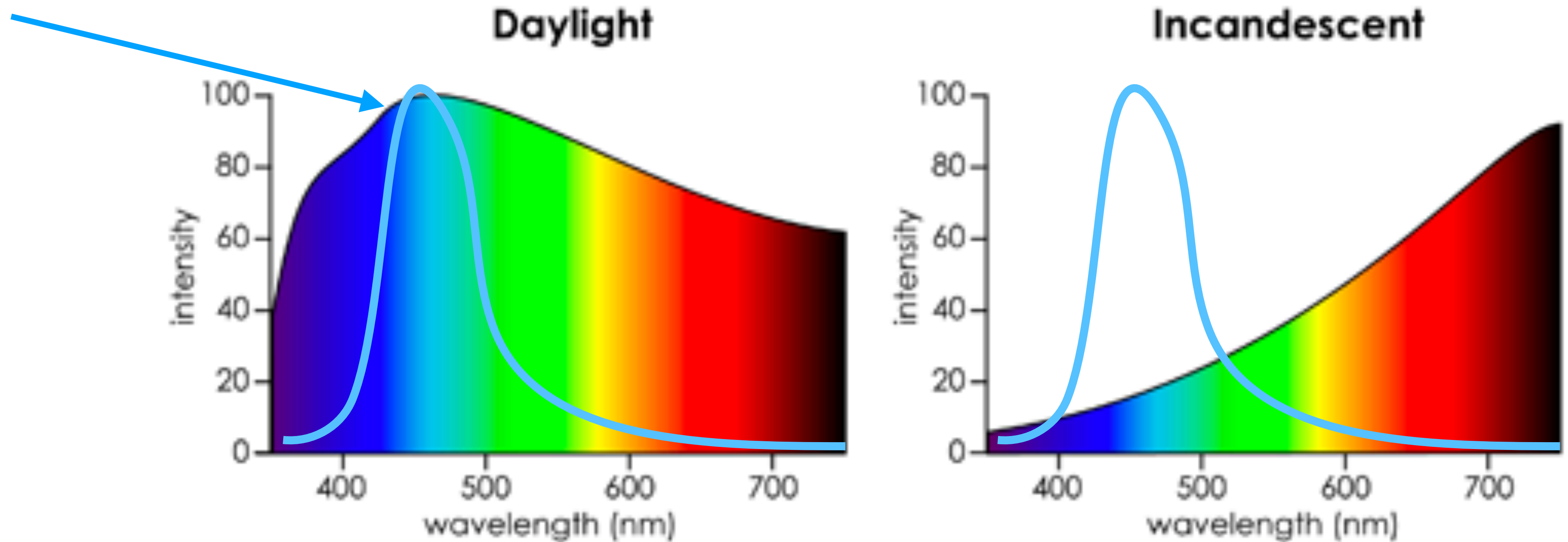

# Do Spectra Ever Matter?

To reveal the “true color” of an object, the light source needs to emit wavelengths that the object reflects.

Of course there is nothing called “true color”. What’s the objective reality is the reflectance spectrum of the object.

But we do have a common color perception of an object, and that perception is obtained/formed with respect to a typical lighting under which the object is usually viewed.

# Color Rendering

**Color rendering** concerns with the ability of a light source to reveal the “true color” of an object, which is the color of an object under a “reference” light.

- The choice of reference light is somewhat arbitrary, but it’s generally white, e.g., daylight.

The reference light is:

- A blackbody radiation (some form of **incandescent** light) when CCT is below 5000K.
- A standard illuminant D (some form of **daylight**) when CCT is above 5000K.

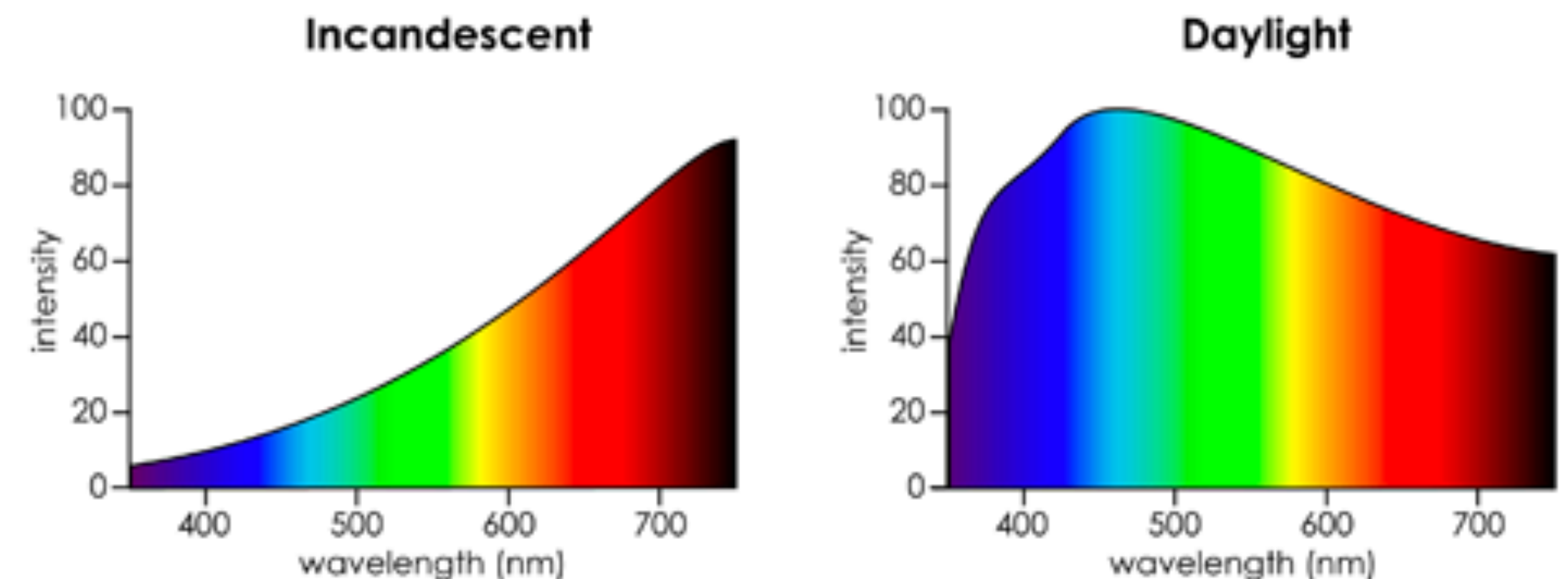

# Color Rendering Index (CRI)

A metric standardized by CIE.

**CRI** quantifies the coloring rendering capability of a given light source w.r.t., a **reference** light under the same correlated color temperature.

- CRI is defined only for light sources that are approximate white, i.e., the chromaticity distance to the Planckian locus is below a threshold.

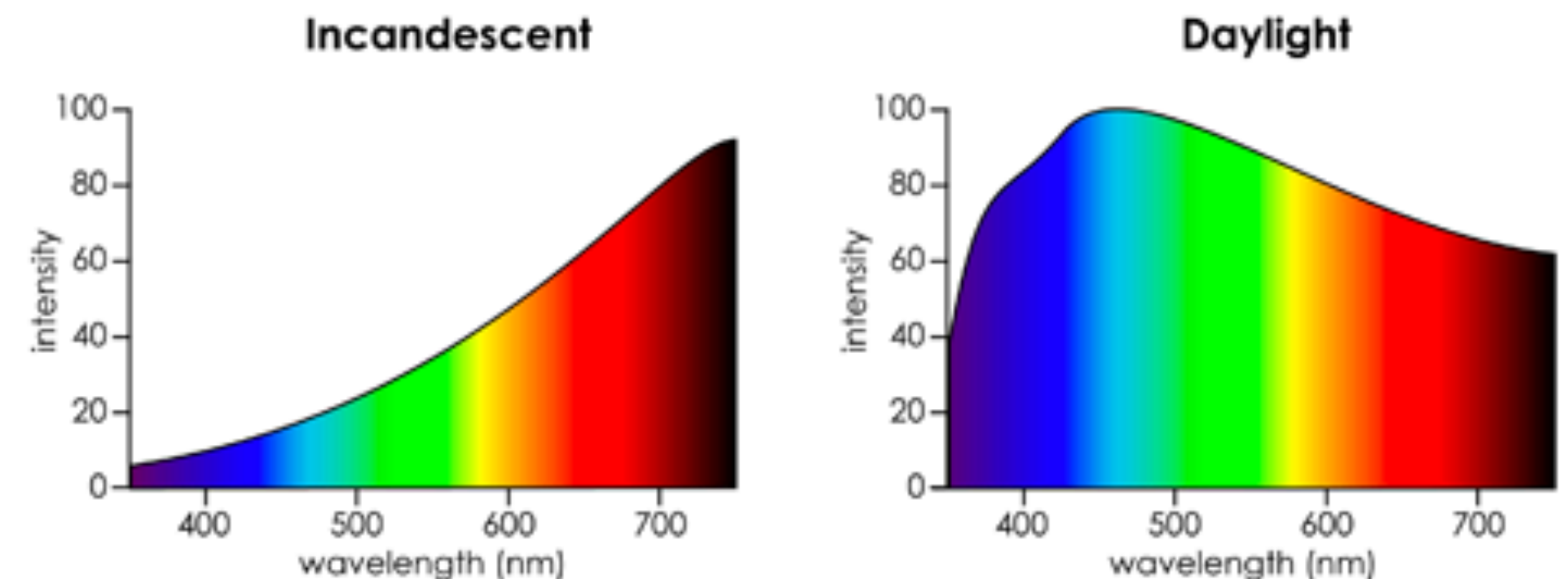



# Calculating Color Rendering Index (CRI)

Pick a set of calibration materials with given spectral reflectance.

For each material, illuminate it with both the test light and the reference light. Calculate the two sets of  $xy$ -chromaticities, apply von Kries chromatic adaptation, and calculate the distance in the  $xy$  diagram.

Take some form of average across the samples and normalize to 100.

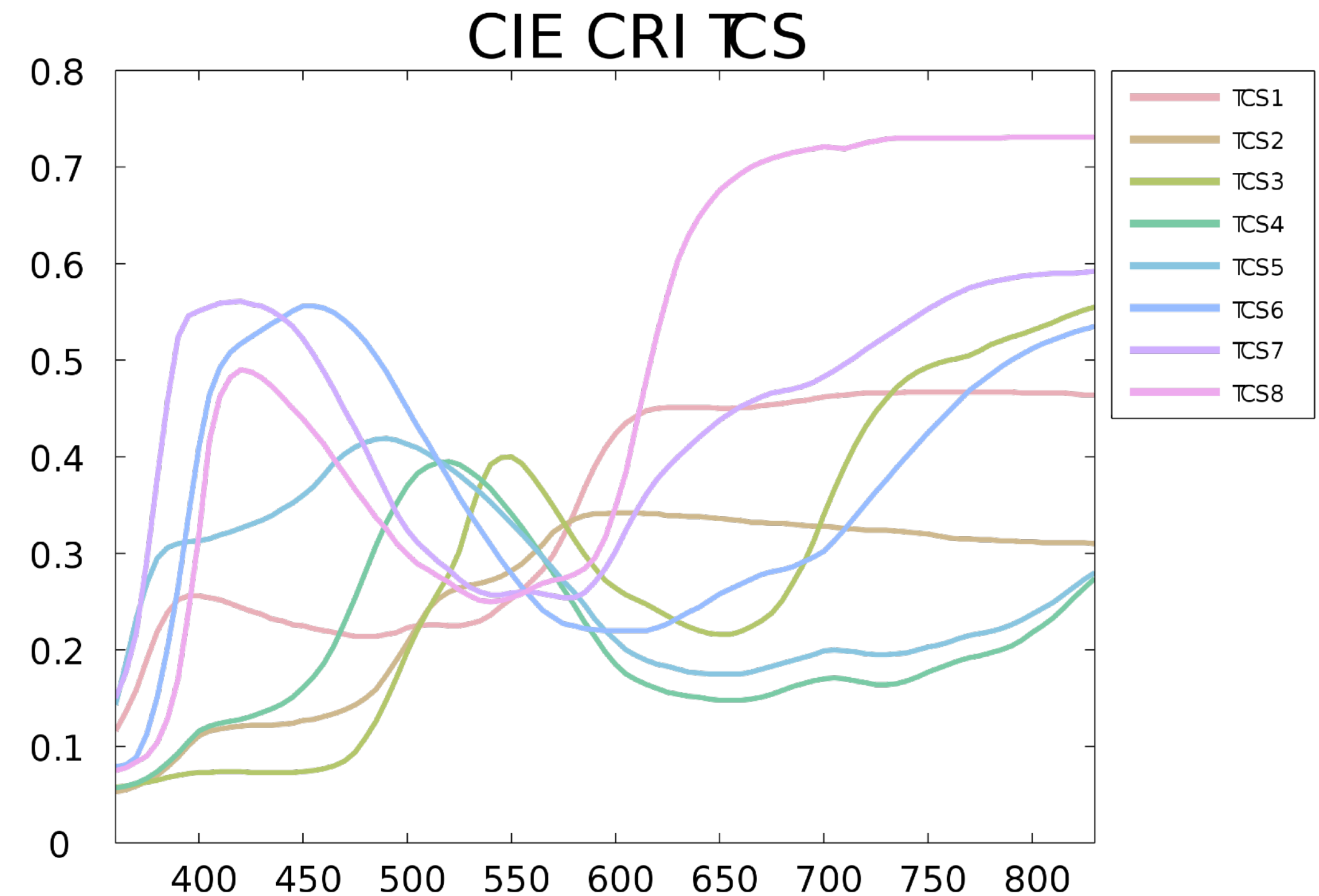

**Reflectance spectra of the calibration samples (CIE 1995)**

# Interpreting CRI

Lights that are more similar to the reference lights (incandescent or daylight) have higher CRIs. Reference lights have a CRI of 100.

Generally, lights with continuous spectra have higher CRIs.

- A continuous spectrum better integrates across the entire visible range.

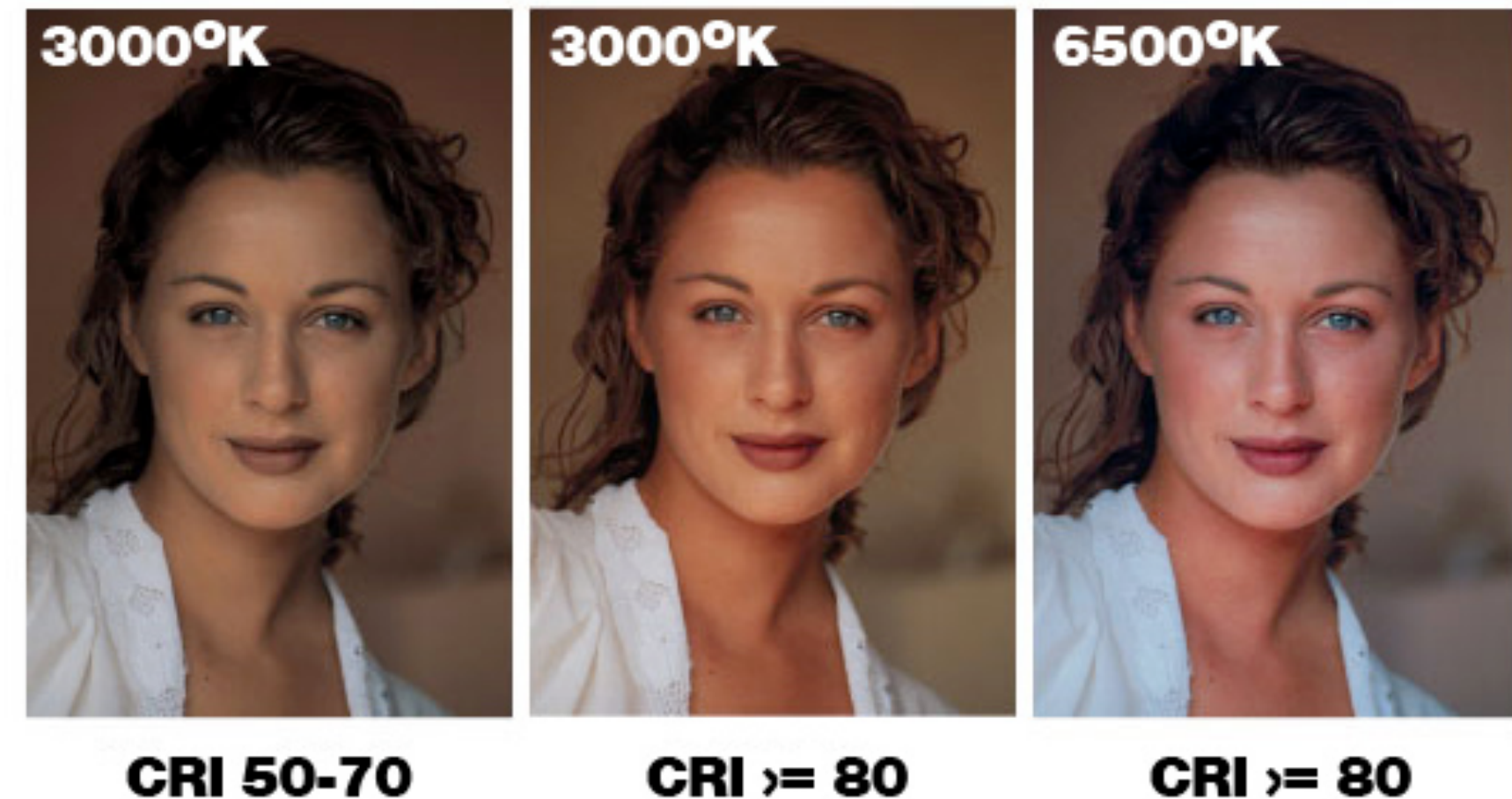

# Display vs. Lighting

We directly look at lights from the display.

- Reproducing the color (using metamerism) is key. Spectrum is not important.

We don't directly look at lights. We use a lighting system mostly to light an object so that we can see the **color of the object**.

- CRI matters the most. Spectrum becomes important.

What happens when we use displays for lighting?

# Display vs. Lighting

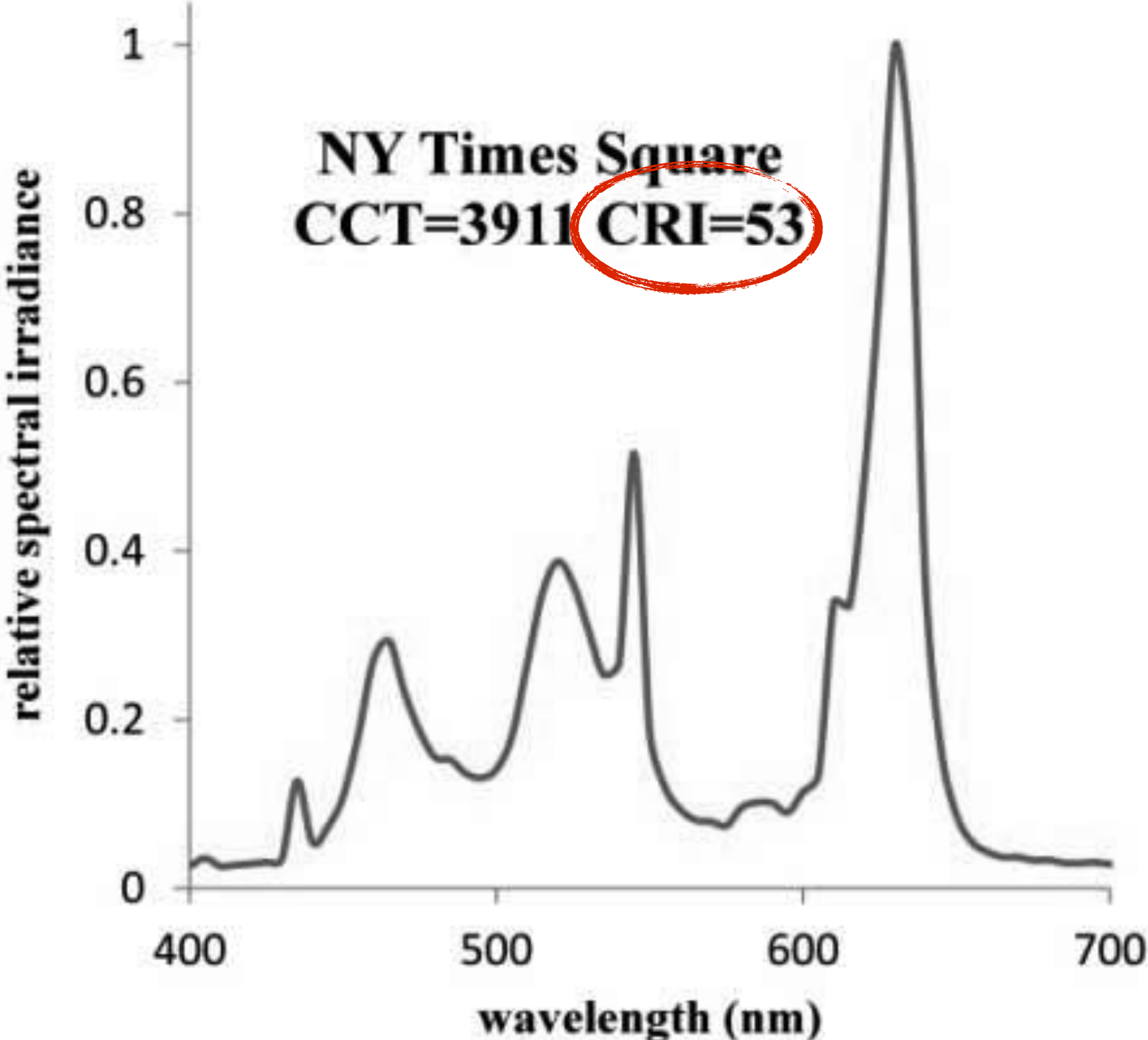

<https://gissler.com/east-42nd-street-walking-tour-of-beautiful-spaces>

# Displays

# Recall: Metamerism

The two lights are metamers of each other if their LMS responses match.

$$\sum_{\lambda} \Phi_1(\lambda)L(\lambda) = \sum_{\lambda} \Phi_2(\lambda)L(\lambda)$$

$$\sum_{\lambda} \Phi_1(\lambda)M(\lambda) = \sum_{\lambda} \Phi_2(\lambda)M(\lambda)$$

$$\sum_{\lambda} \Phi_1(\lambda)S(\lambda) = \sum_{\lambda} \Phi_2(\lambda)S(\lambda)$$

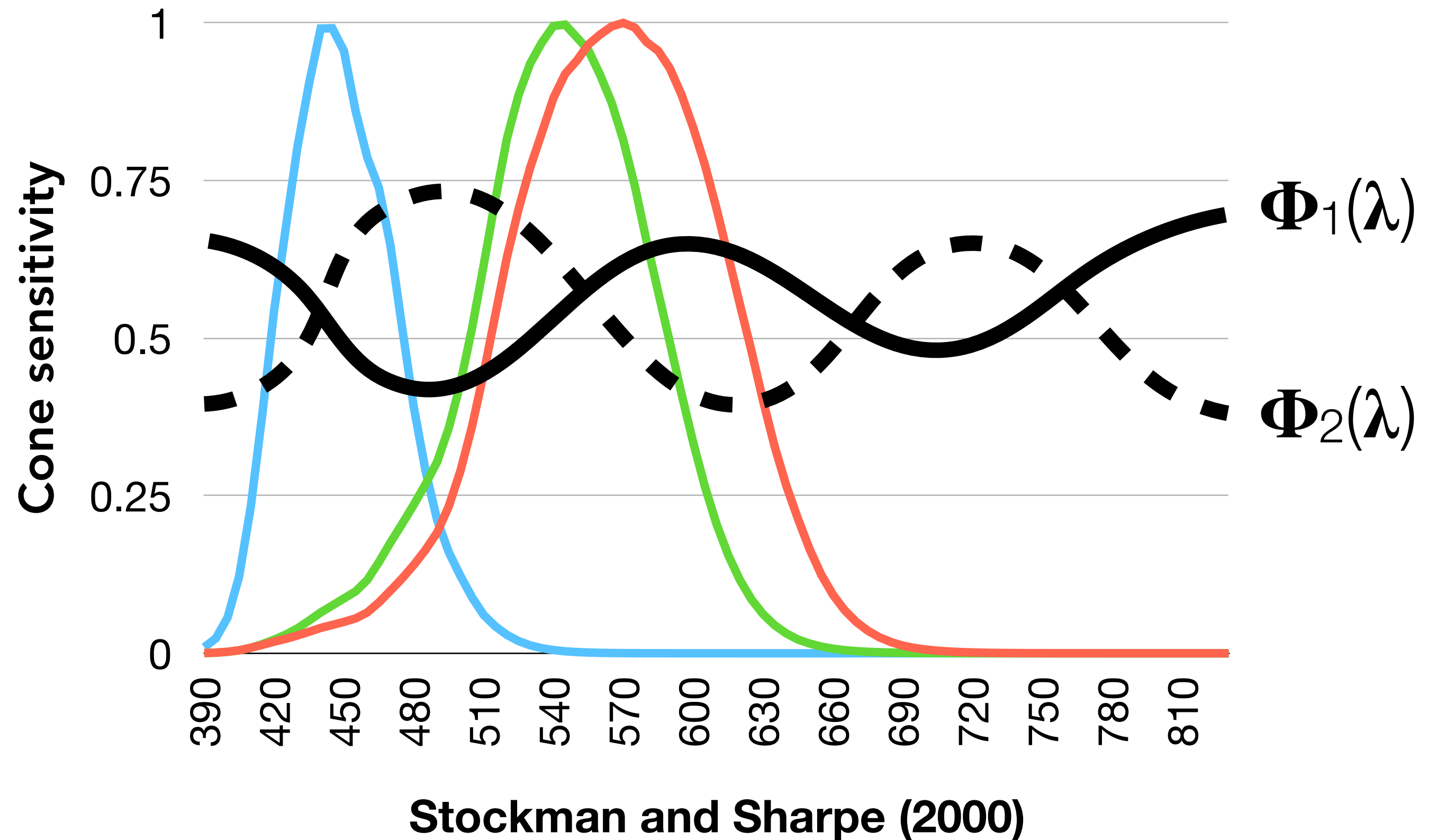

# Recall: Trichromatic Theory of Color

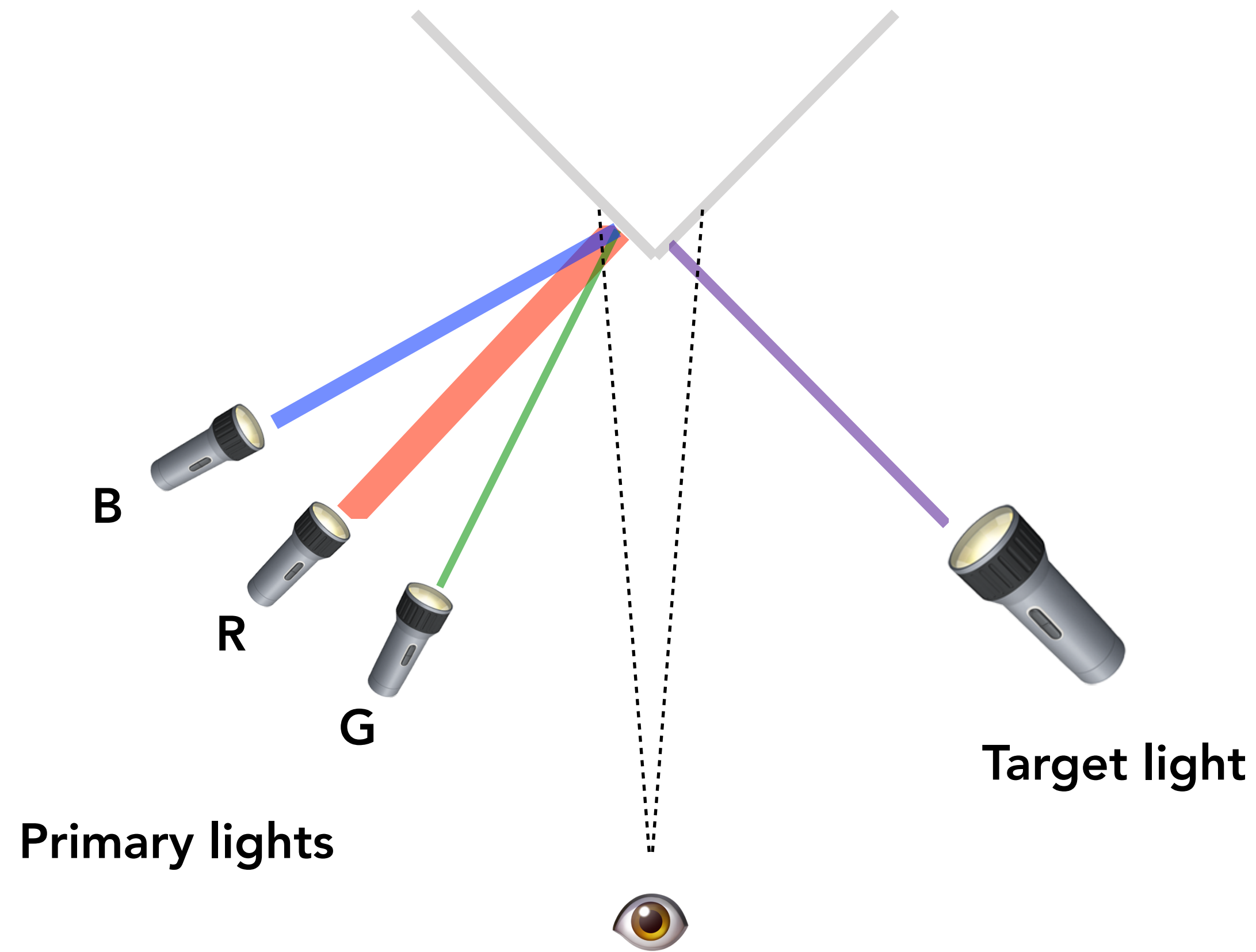

We can match the color of a given light by mixing three primary colors.

- Provided that the primaries are carefully chosen so that the target color falls within the gamut of the color space.

For displays, this means we don't need to produce the exact light **spectrum** if our goal is simply to produce the desired **color**.

# Basic Principle: Spatial Integration

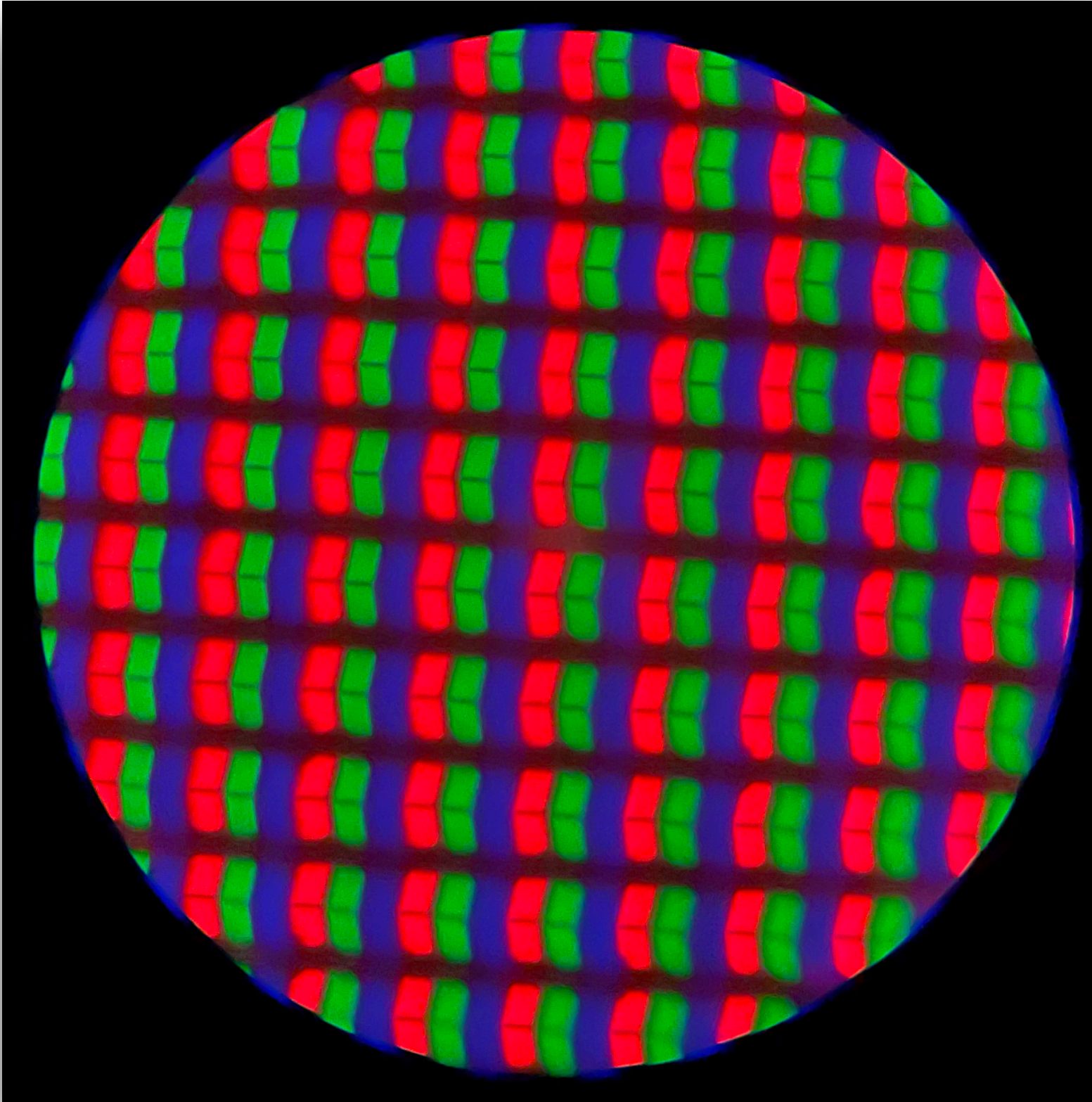

iPhone 6

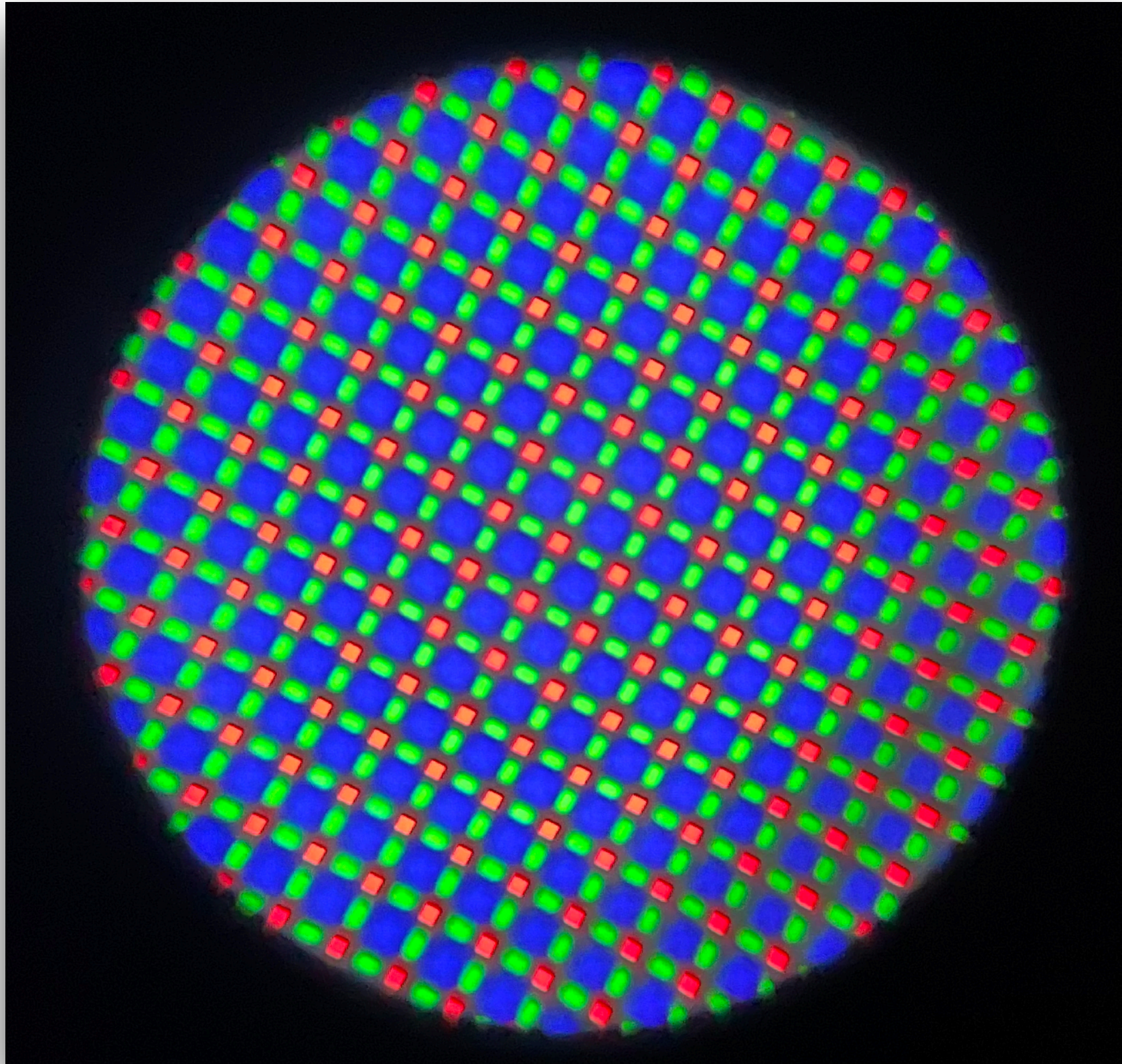

iPhone 14 Pro

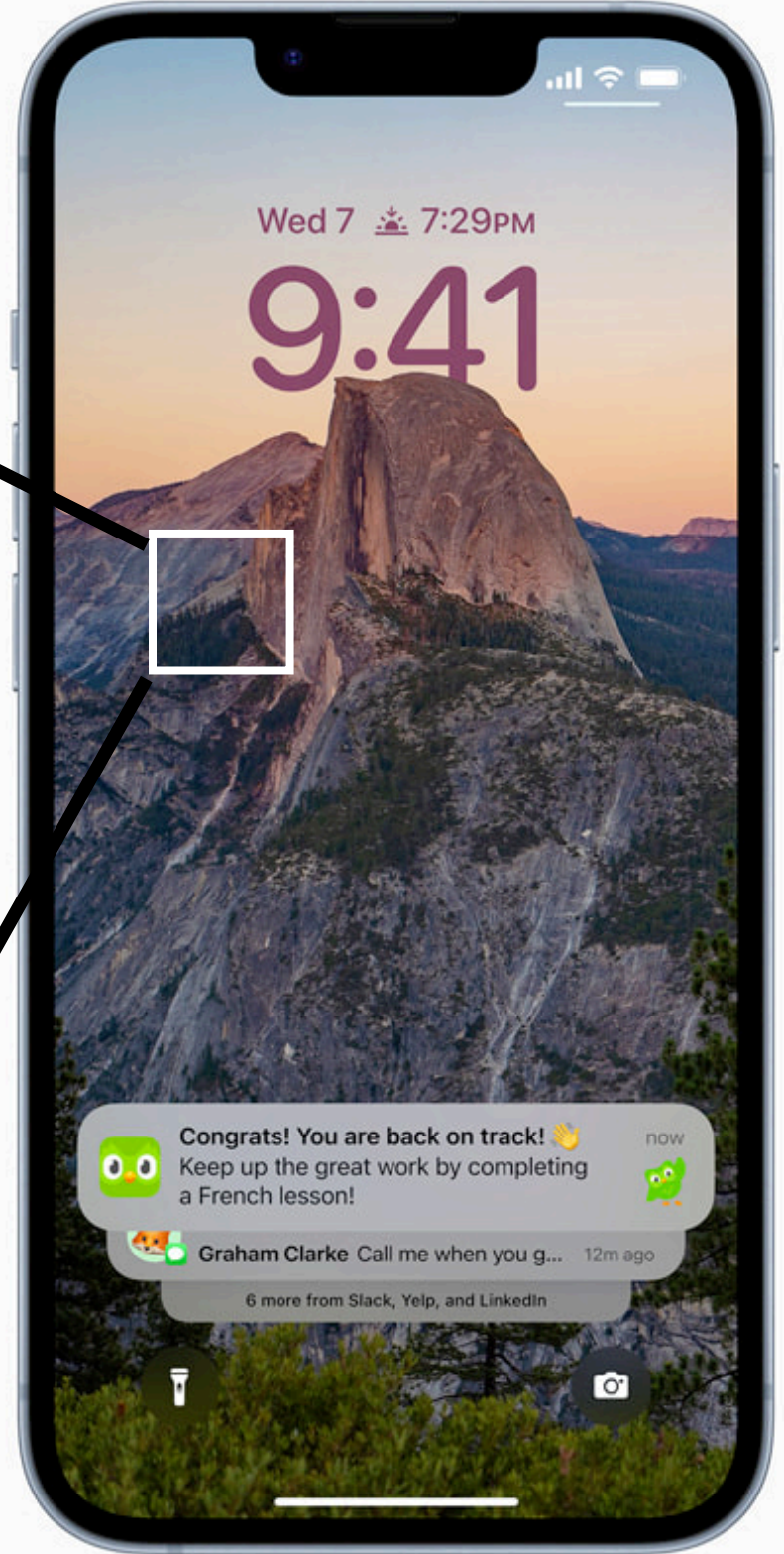



# Two Main Display Mechanisms

Emissive Displays  
(e.g., OLED)

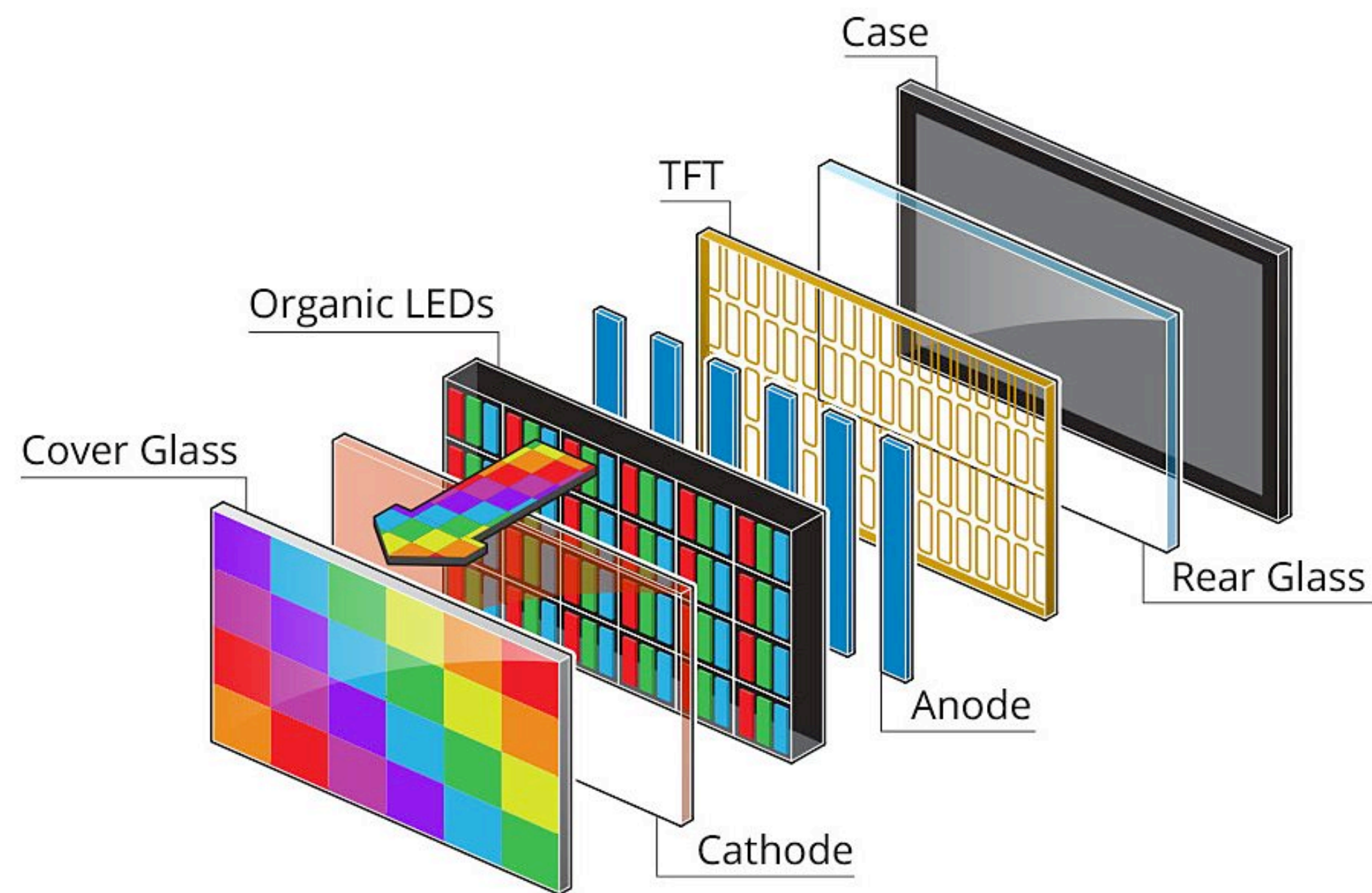

Light-Filtering Displays  
(e.g., LCD/Projector)

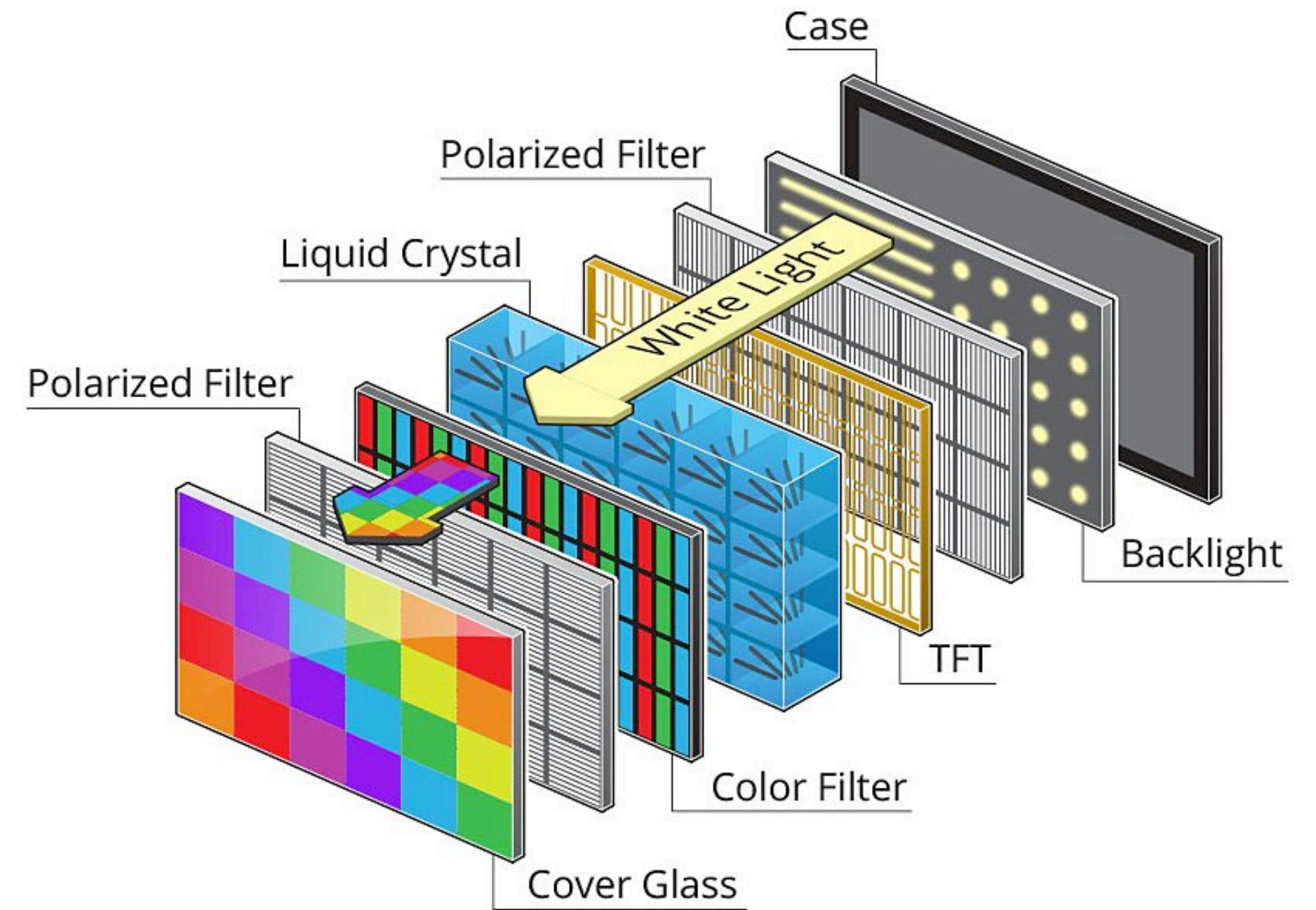

# Light-Emitting Diodes: Photons From Electrons

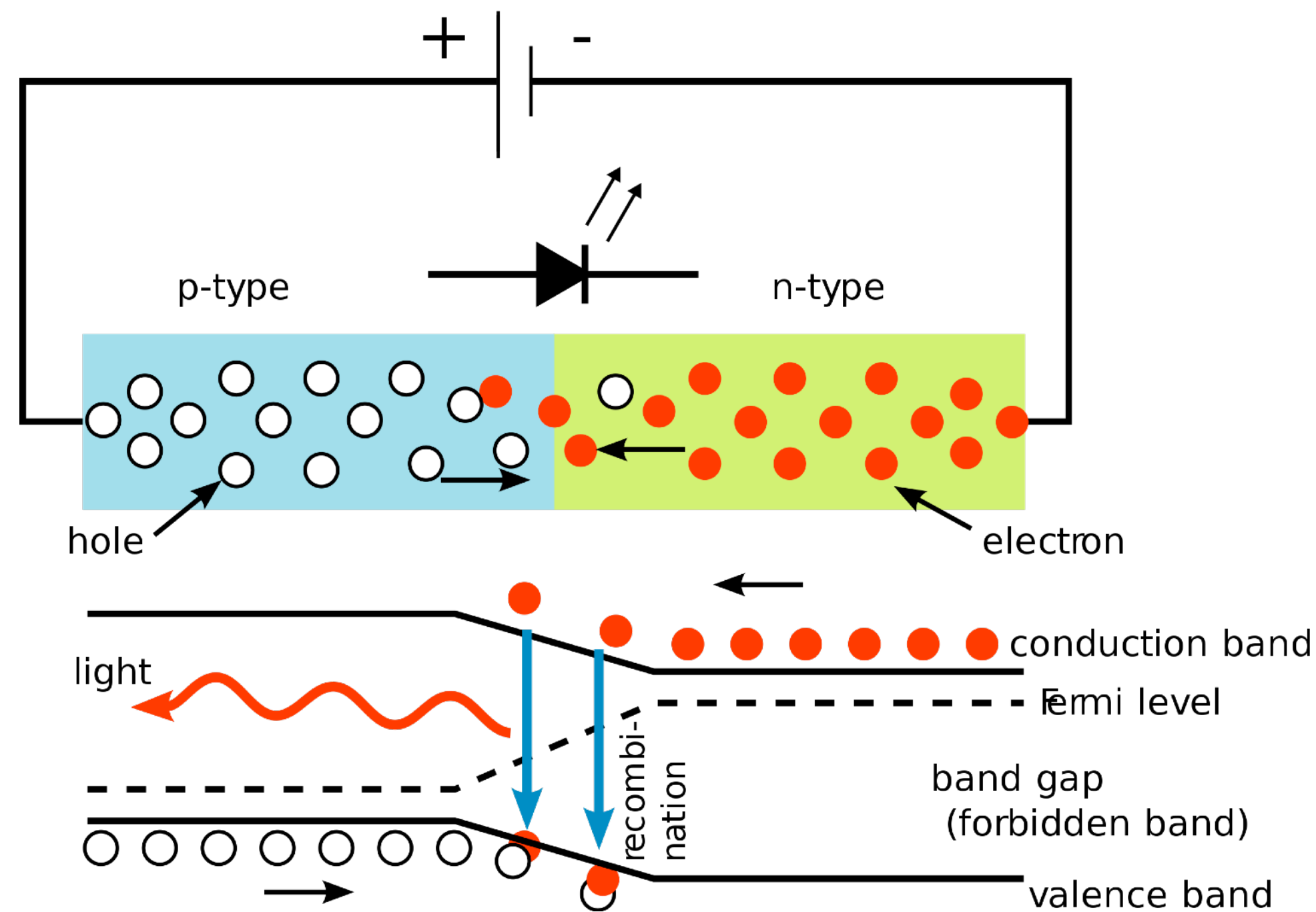

External power creates potential differences that move electrons from the n-side (higher energy state) to the p-side (lower energy state), releasing photons.

The photon wavelength depends on the energy gap, which depends on material.

A form of electroluminescence.

- Variants: OLED, QLED, AMOLED, etc.
- Two common materials: AlGaInP and InGaN.

# Light-Emitting Diodes (LED)

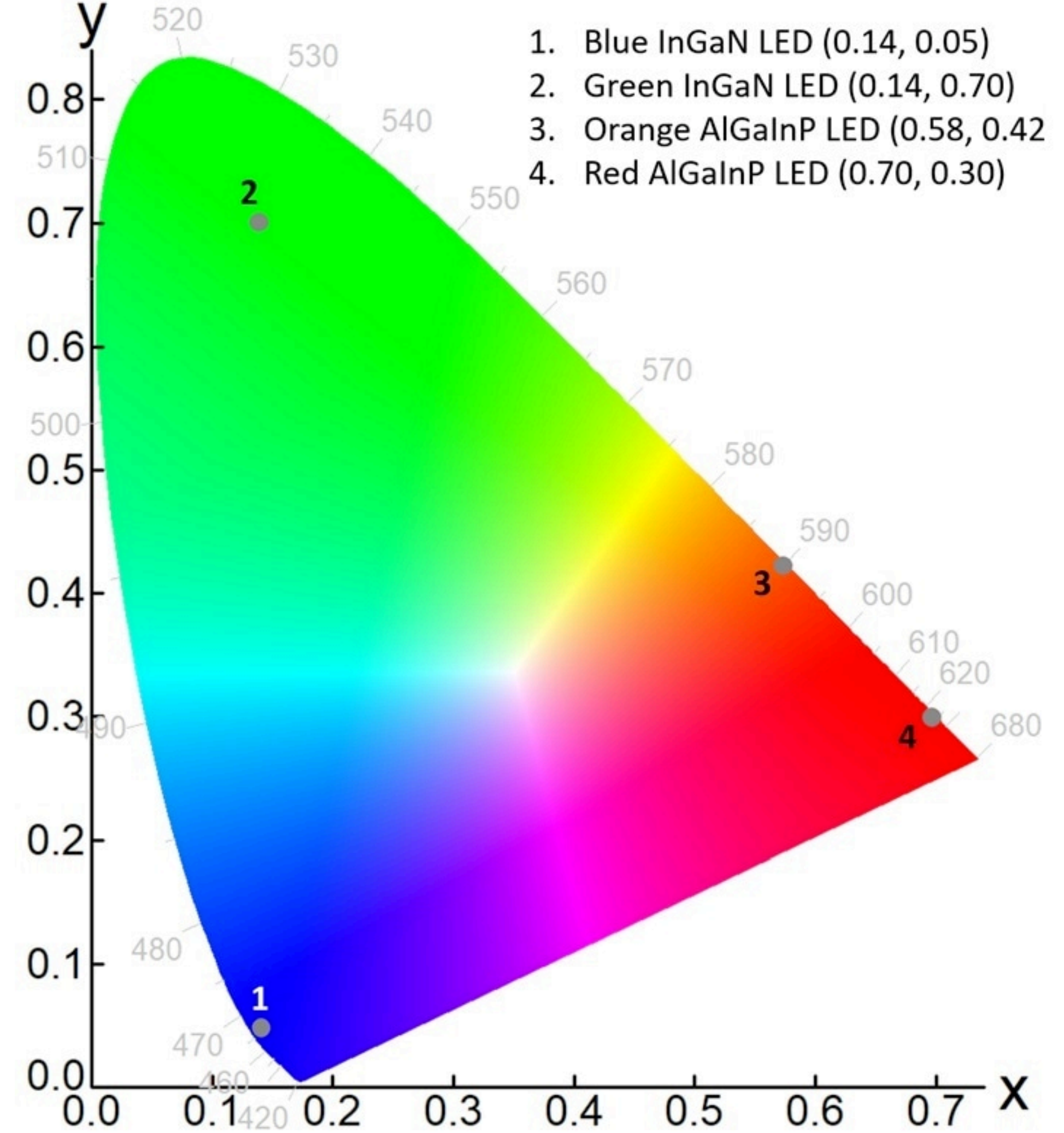
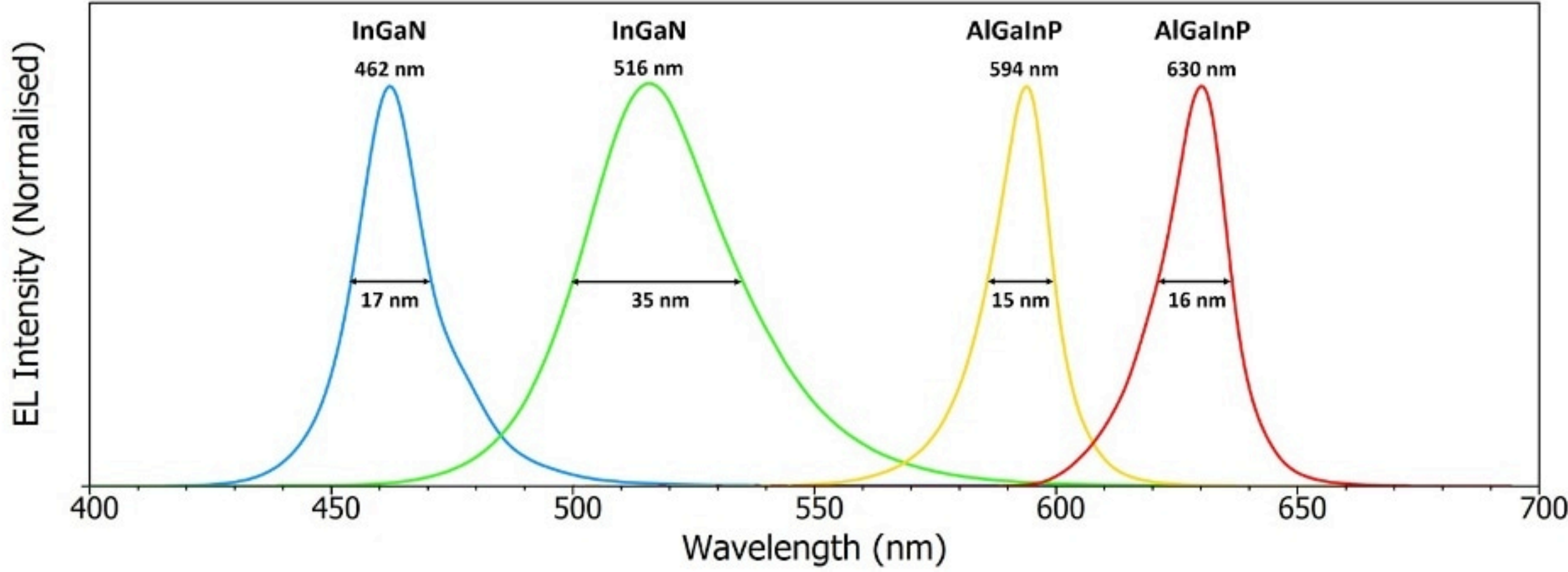

# OLED Pixel Circuit

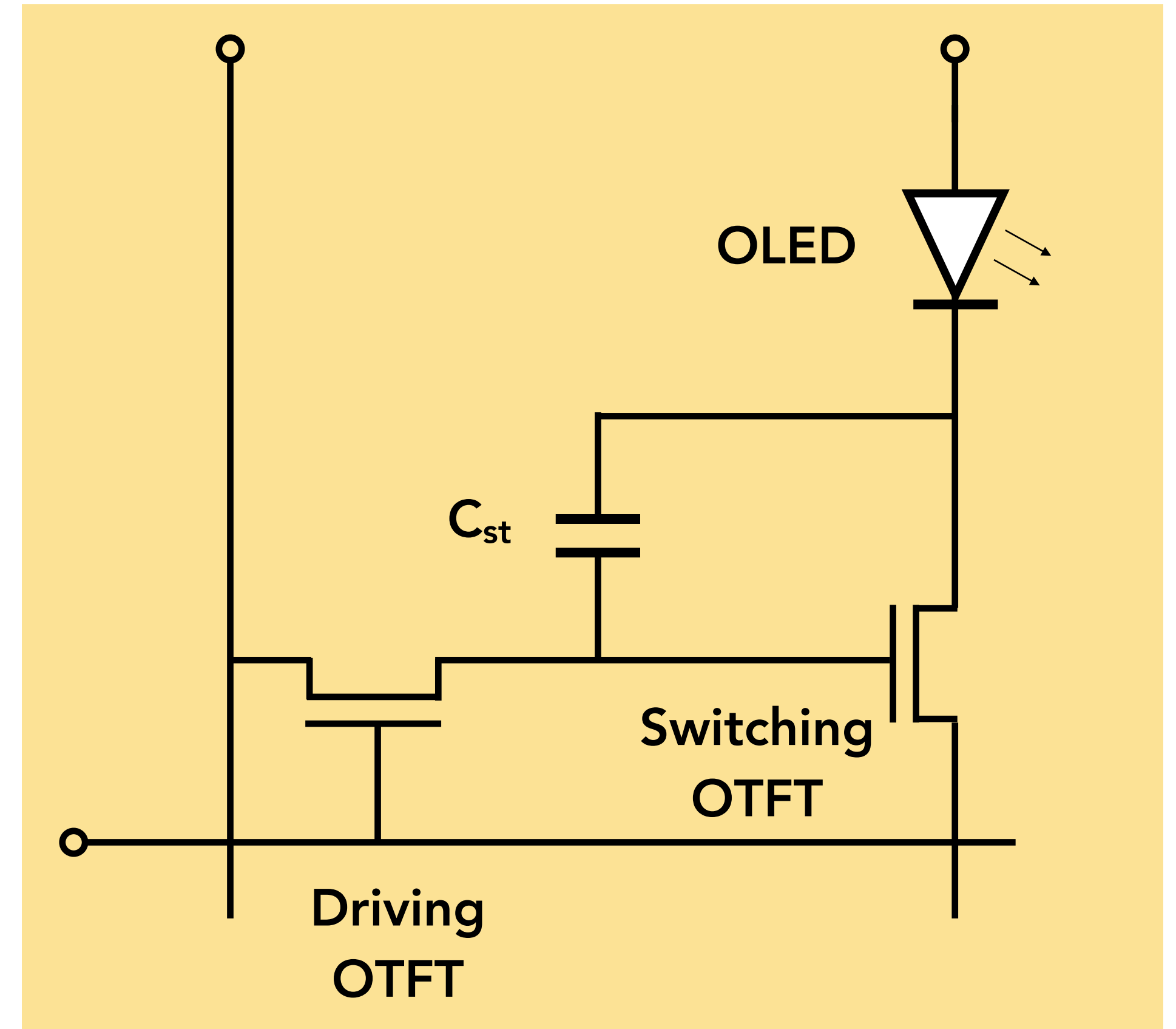
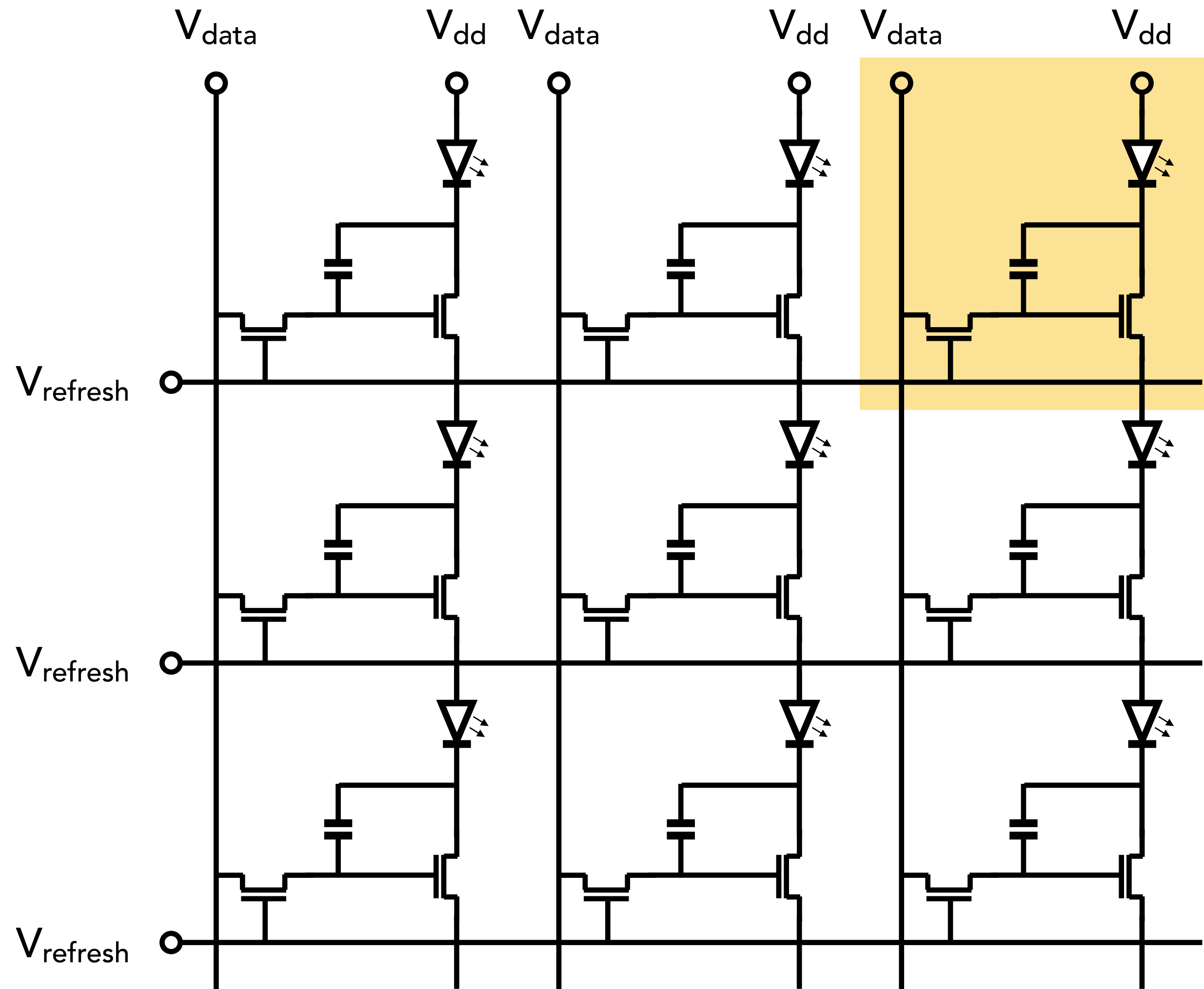

# OLED Pixel Circuit

The array is organized much like a SRAM array.

Each row is refreshed separately.

The capacitor holds the charge before next refresh.

The two thin-film transistors (TFTs) control the charging of the capacitor and driving the OLED.

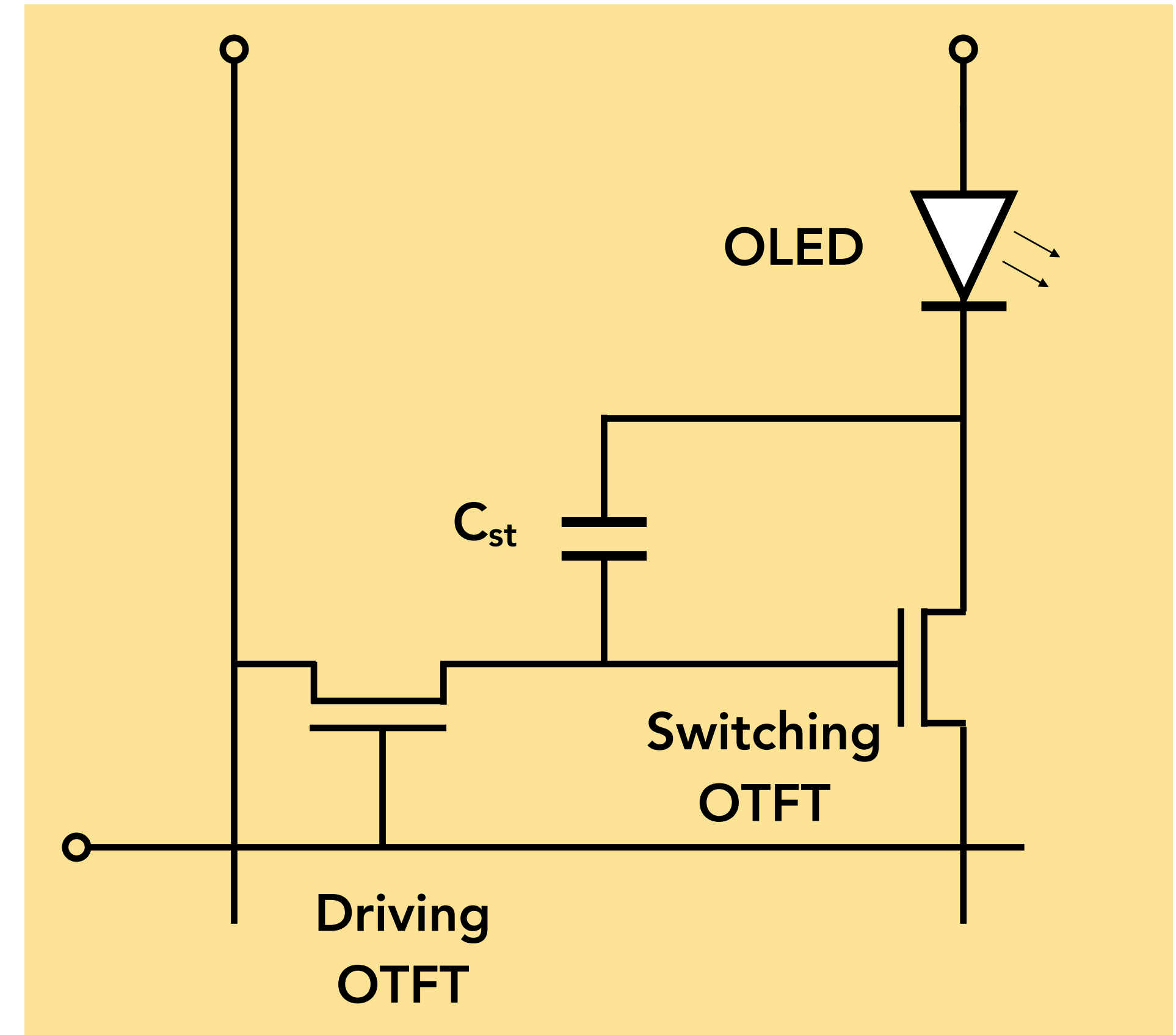

# Controlling Intensity of LEDs

The **higher** is the **current** of the driver circuit and the **lower** is the **temperature**, the higher is the light output intensity (luminous flux).

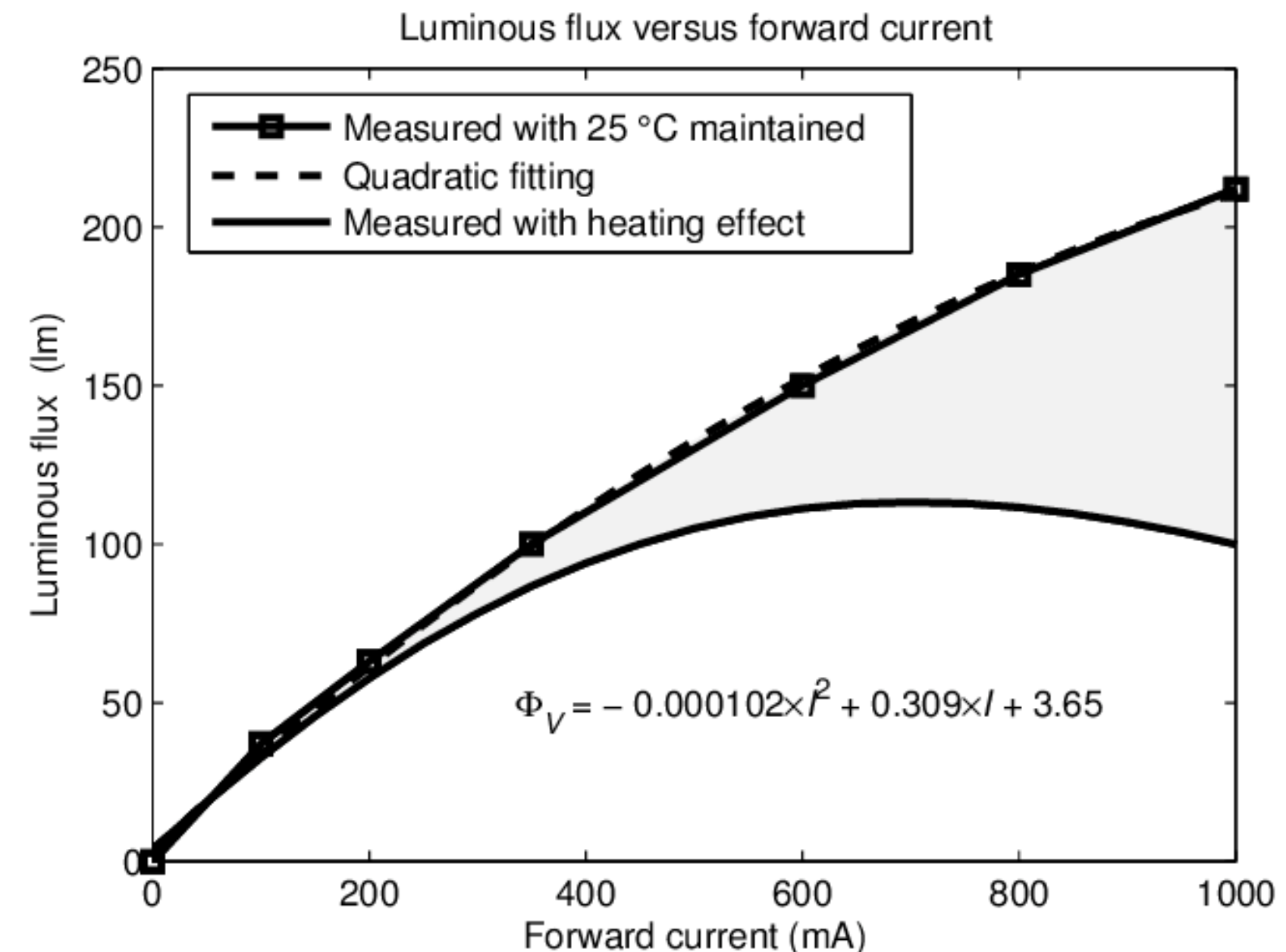
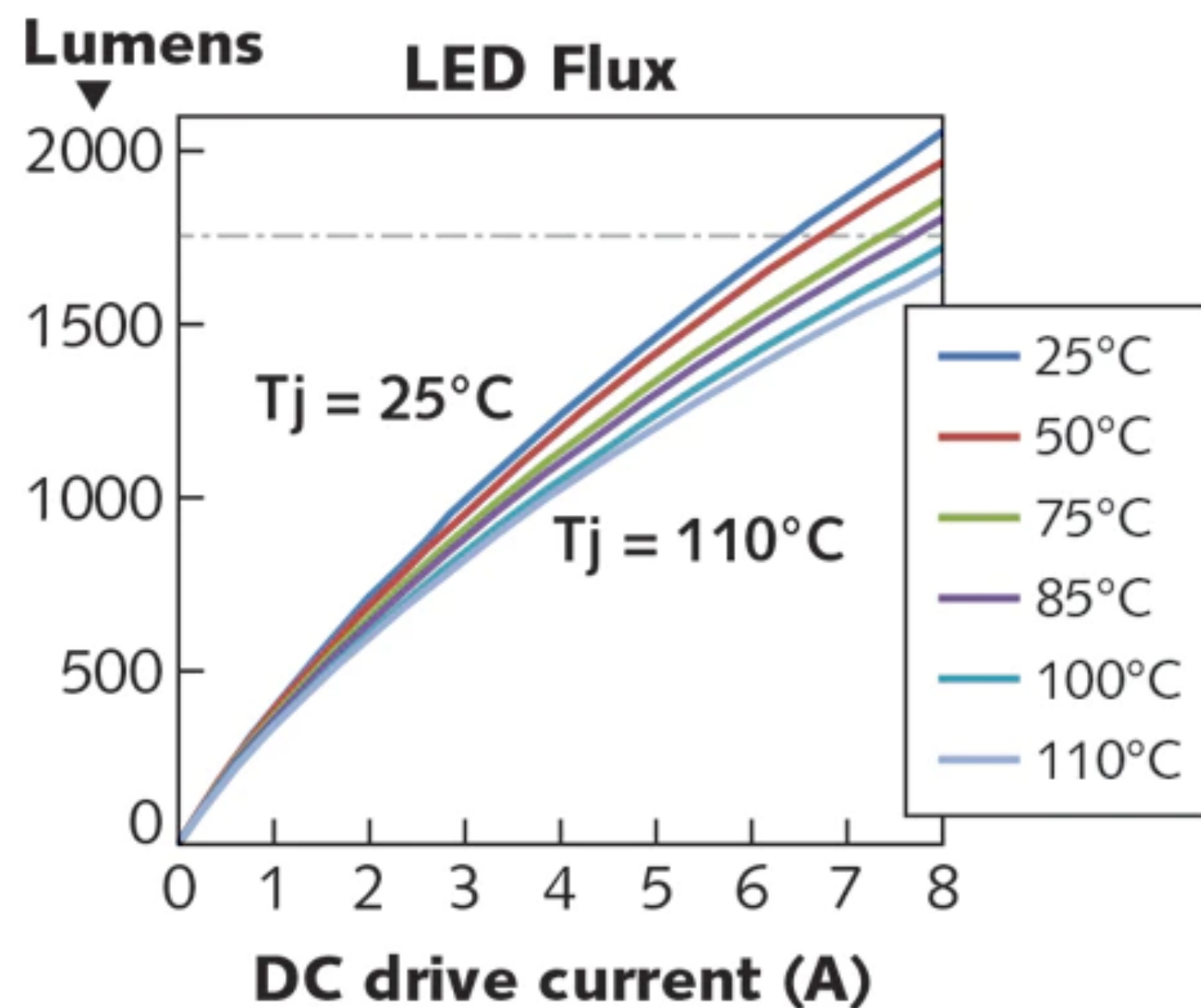

# OLED Display Power vs. Color

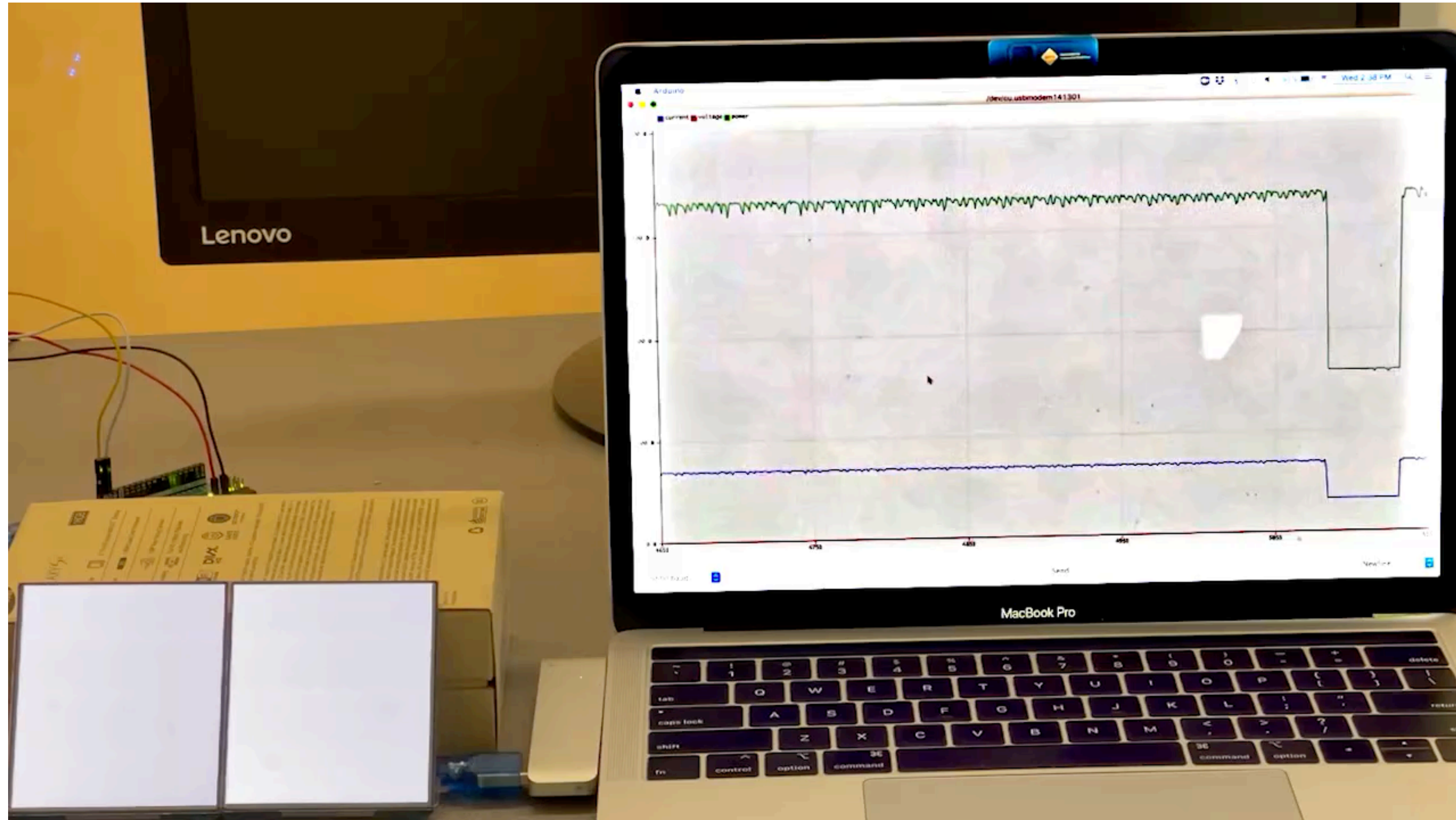

Power

Current

# OLED Display Power vs. Color

$$\text{Power} = 233.5 * \mathbf{R} + 209.6 * \mathbf{G} + 567.7 * \mathbf{B} + 983.8 \text{ (unit is mW)}$$

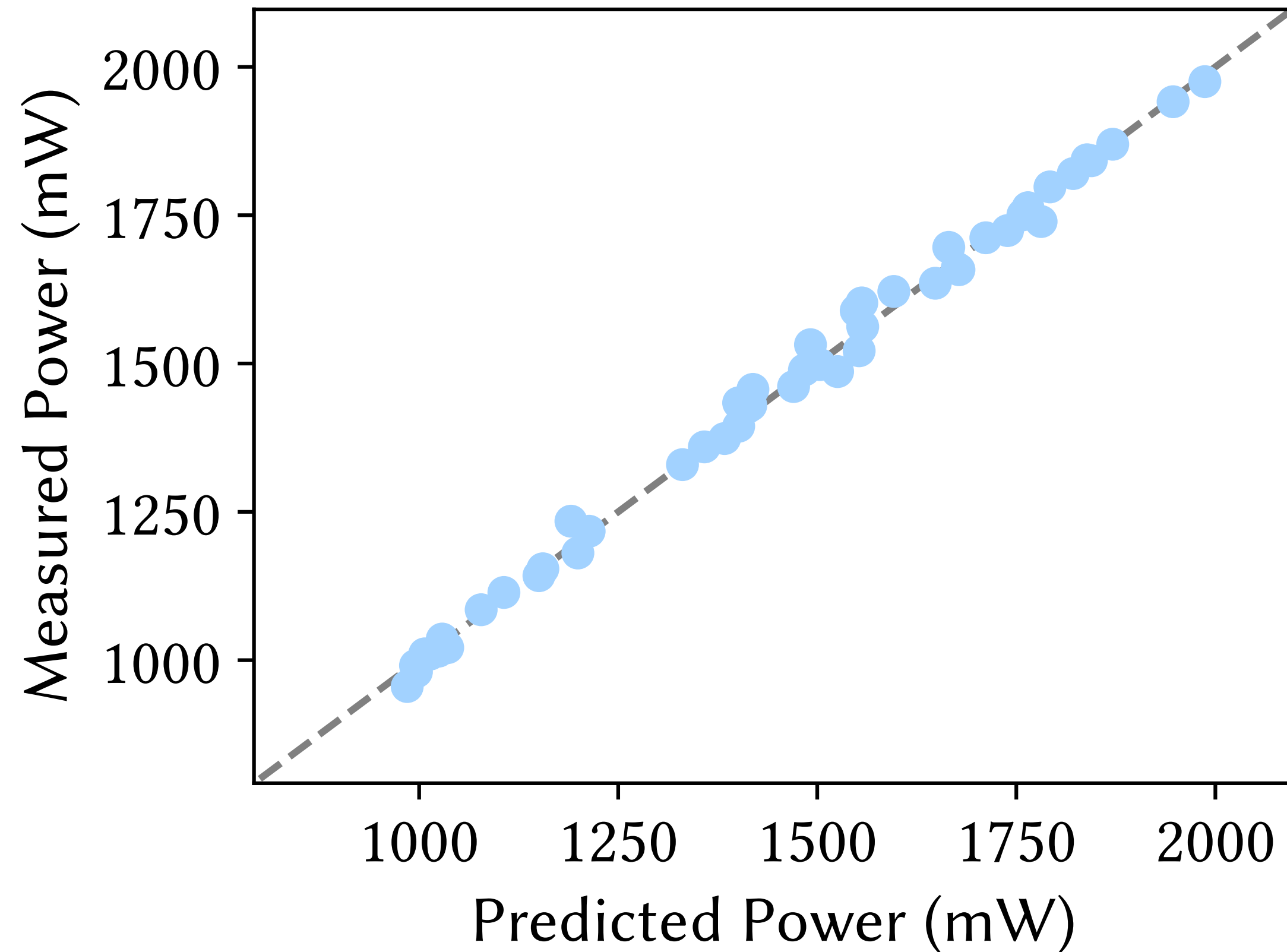

Wisecoco AMOLED Display (1200x1080)

## Setup:

- All pixels display the same color.
- R, G, B are linear sRGB values (without gamma) and in the [0, 1] range.

The intercept (983.8) represents the circuit power independent of color.



# Producing White in Emissive Display

Mixing different colored LEDs.

Trade-off:

- More primaries means more stable white (one primary being off a little doesn't affect the "whiteness" much).
- More primaries means more LEDs (form factor). The luminance efficacy (lumen/watt) might be lower depending on what LEDs are used.

LEDs age at different rates; adjustment.

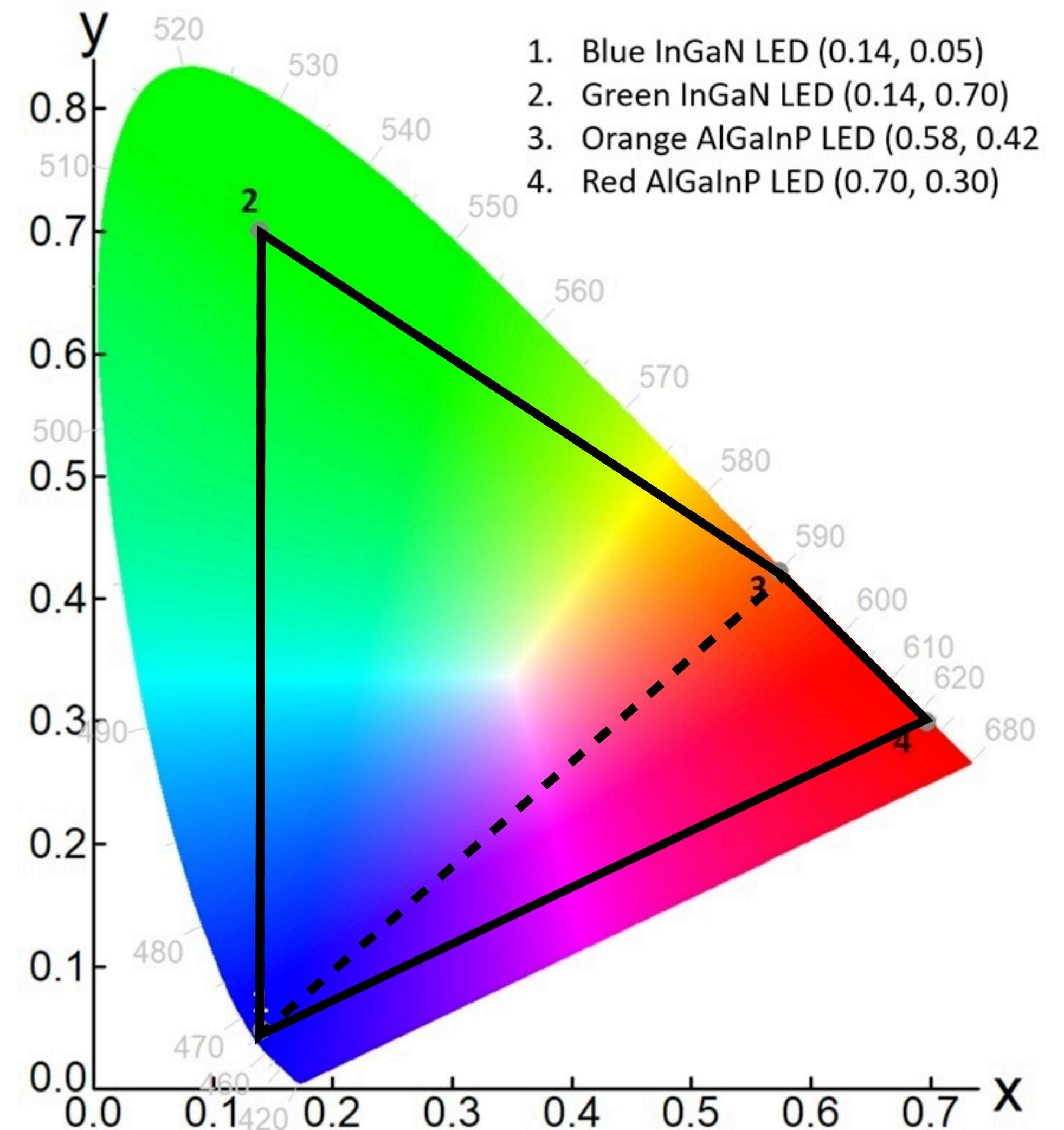

# White LED

<b>Backlight</b>	
The backlight is the source of light of the LCD display panels. The type of backlight determines the image quality and the color space of the display. There are various backlights such as CCFL, LED, WLED, RGB-LED, and etc.	W-LED

**From my LG LCD monitor**

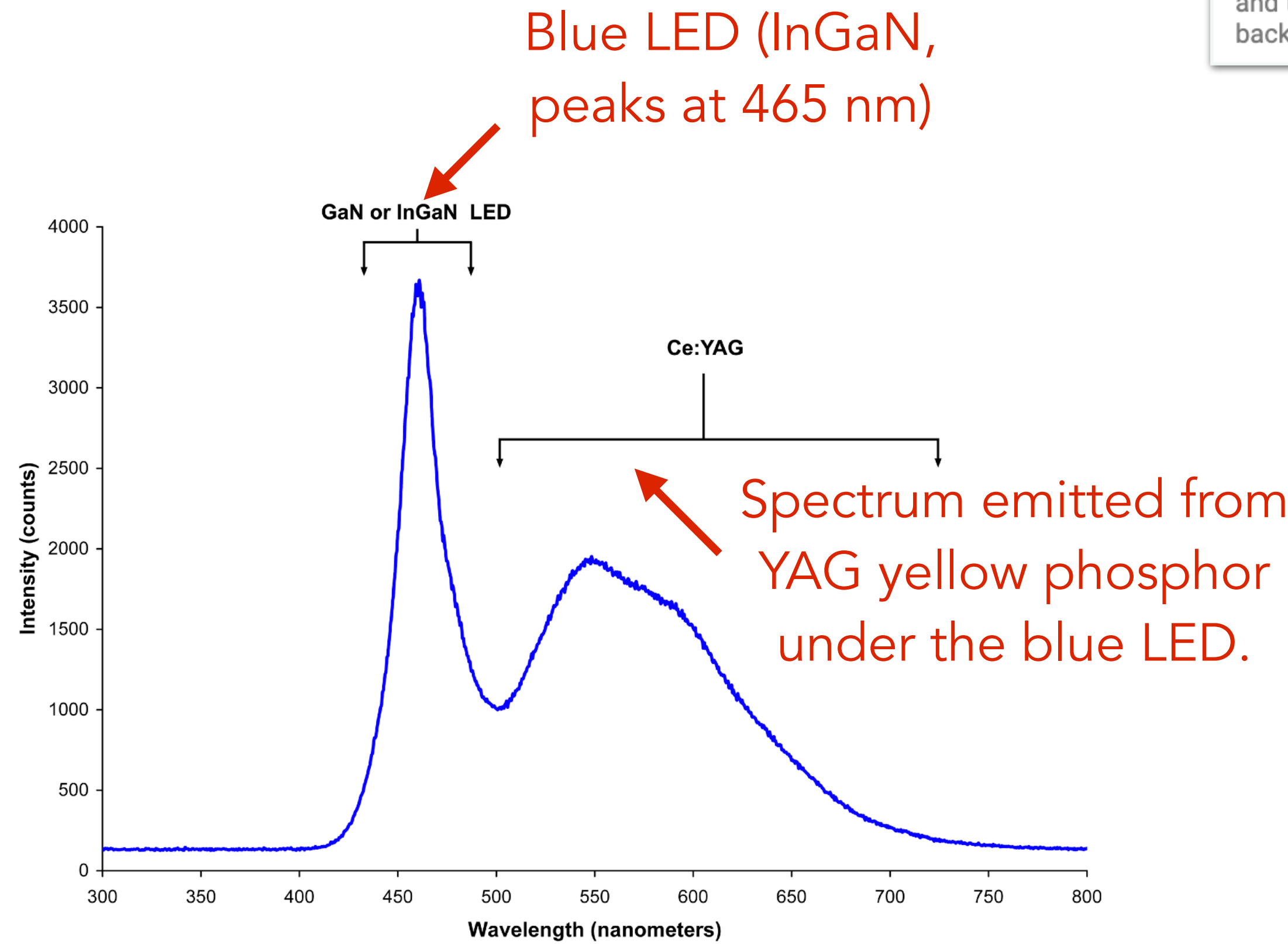

Use a blue LED to light fluorescent materials, which generate (usually) yellow spectrum.

- Also called "phosphor-converted white LED".

# RGBW Sub-Pixel Structure

Some displays use the RGBW sub-pixel structure, which adds white sub-pixels.

Why?

- Use W in place of R+G+B to improve power efficiency
- Add W to boost brightness (think of it as adding power to each of the RGB sub pixels). Sacrifice color fidelity; common in projectors.

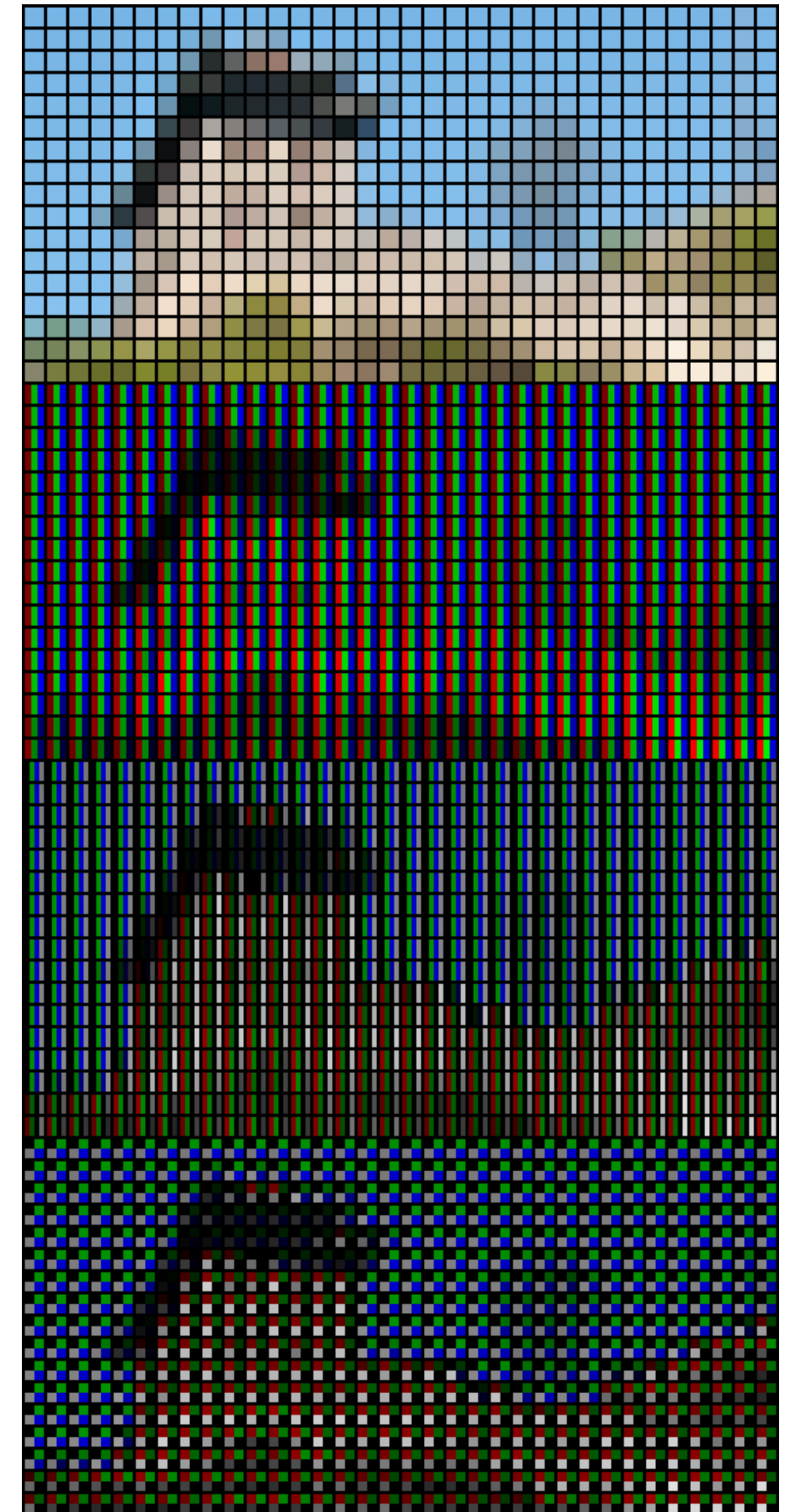
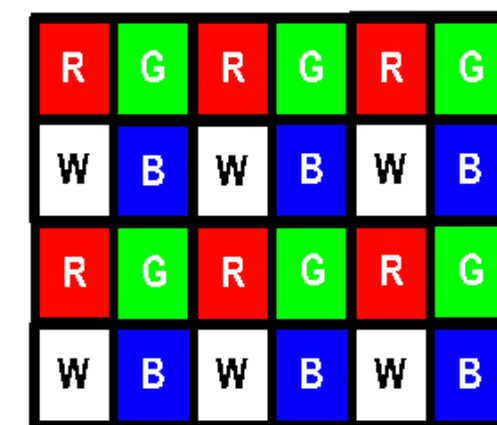
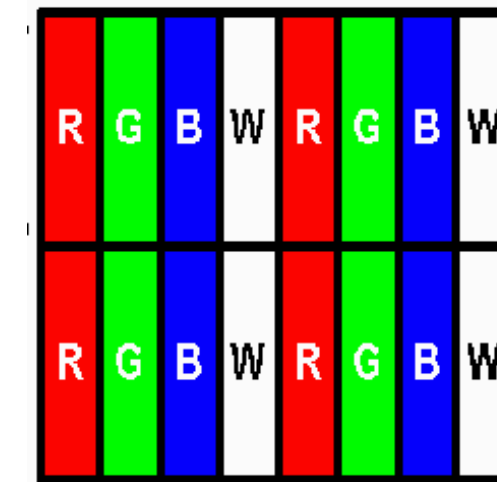
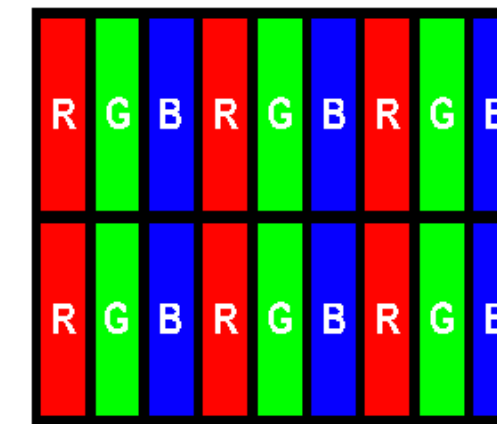

# Light-Filtering Display

White light source is **filtered** and attenuated at each pixel to control color and light intensity.

Used in Liquid Crystal Displays (LCD) and DLP projectors.



# Controlling Intensity of LCD Pixels

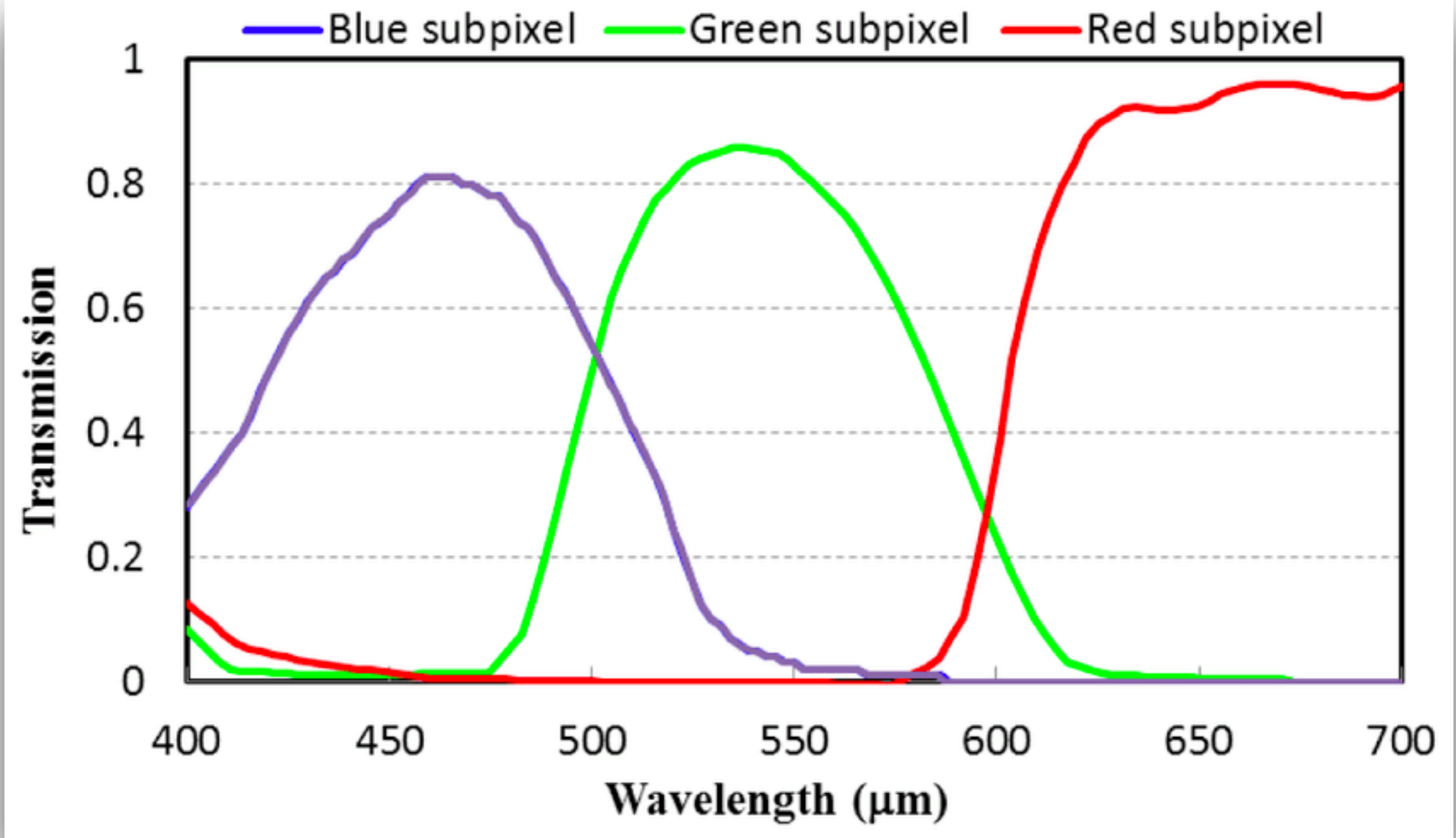
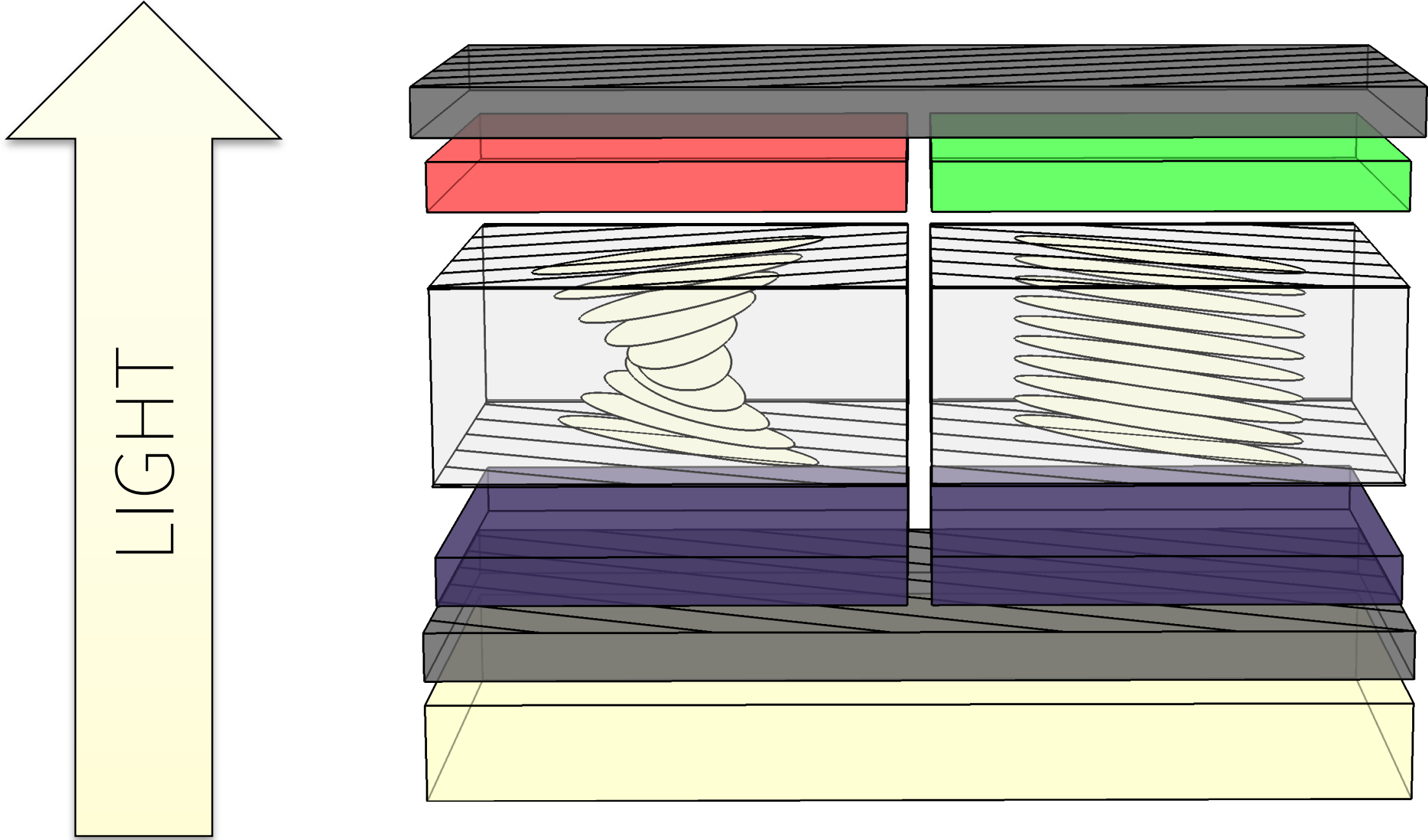

- TFT and Electrodes
- Rear Polarizer
- Backlight

White back light

# Controlling Intensity of LCD Pixels

In natural state, the liquid crystal rotates light by  $90^\circ$  so that light passes through the output polarizer.

When applied electric field, the liquid crystal causes no change to light, which is blocked by the output polarizer.

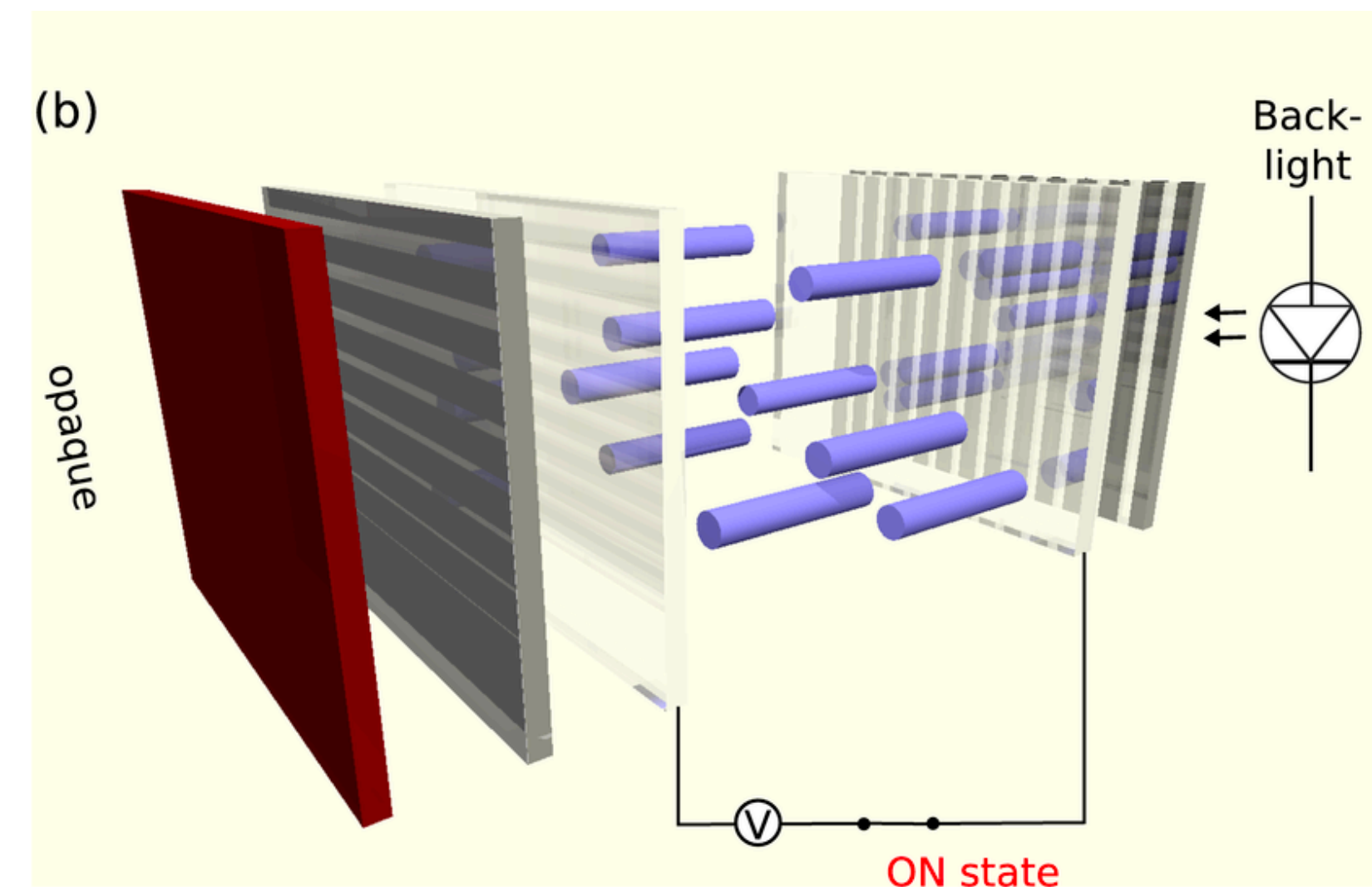
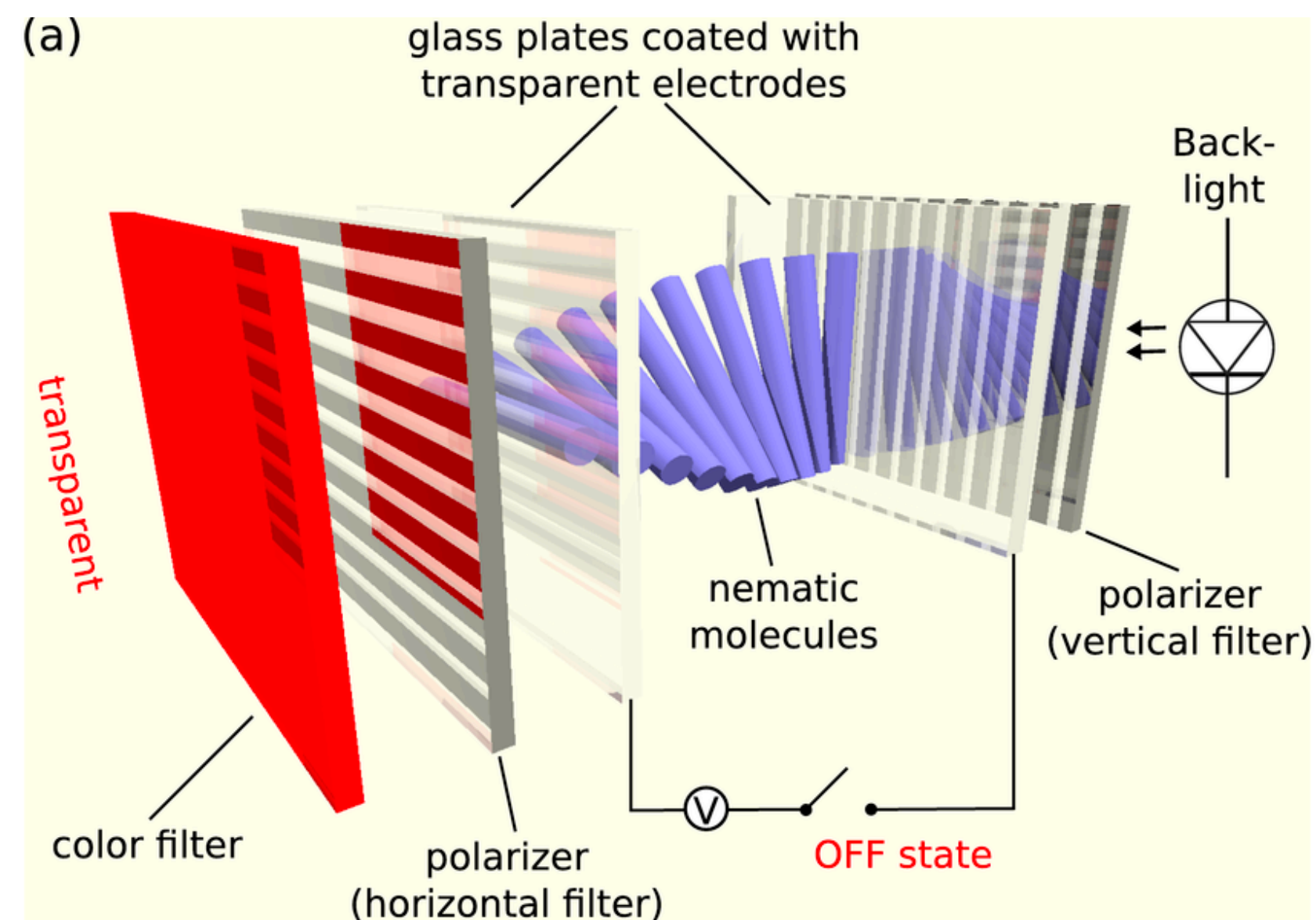

# Controlling Intensity of LCD Pixels

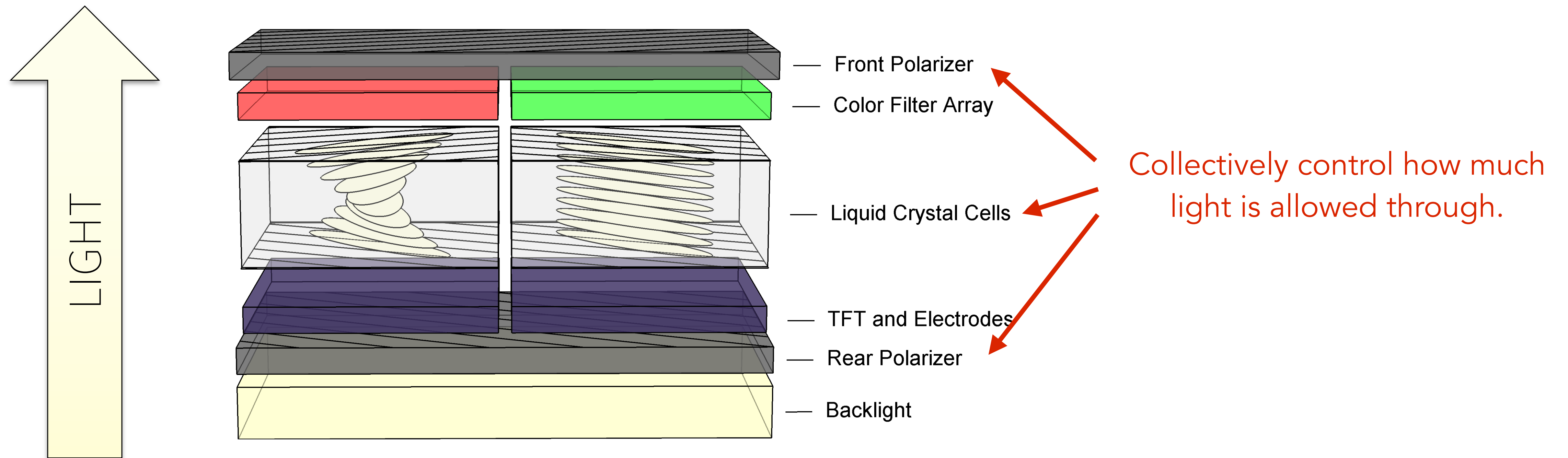

# LCD Pixel Array Circuit

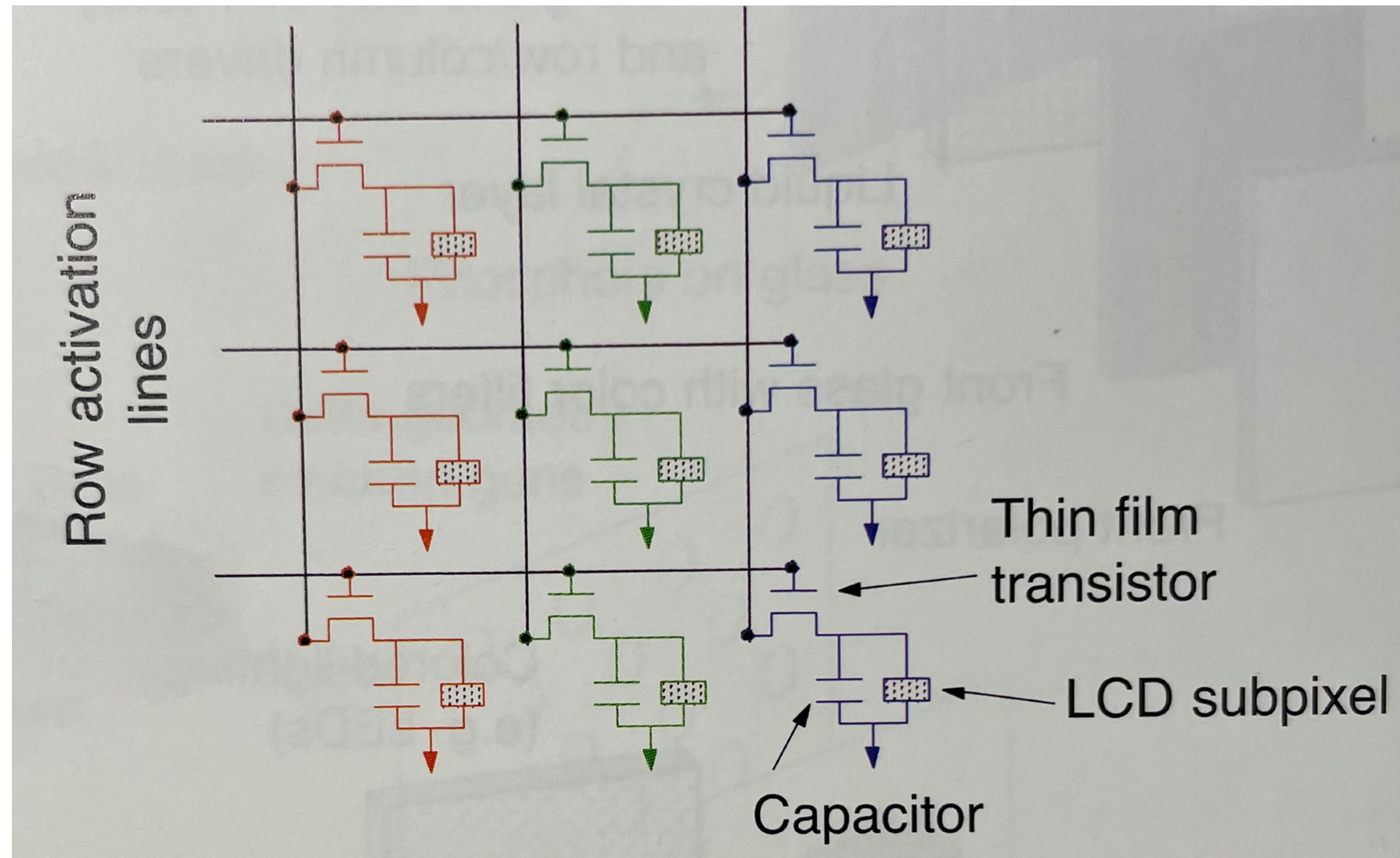

Array-like structure, similar to OLED/SRAM. Each row is refreshed separately.

The thin film transistor acts as an access switch. The capacitor holds the charge before next refresh.



# **“Low-Persistent” Displays**

# Refresh Rate and Motion Blur

Actual Object  
Movement  
(Continuous)

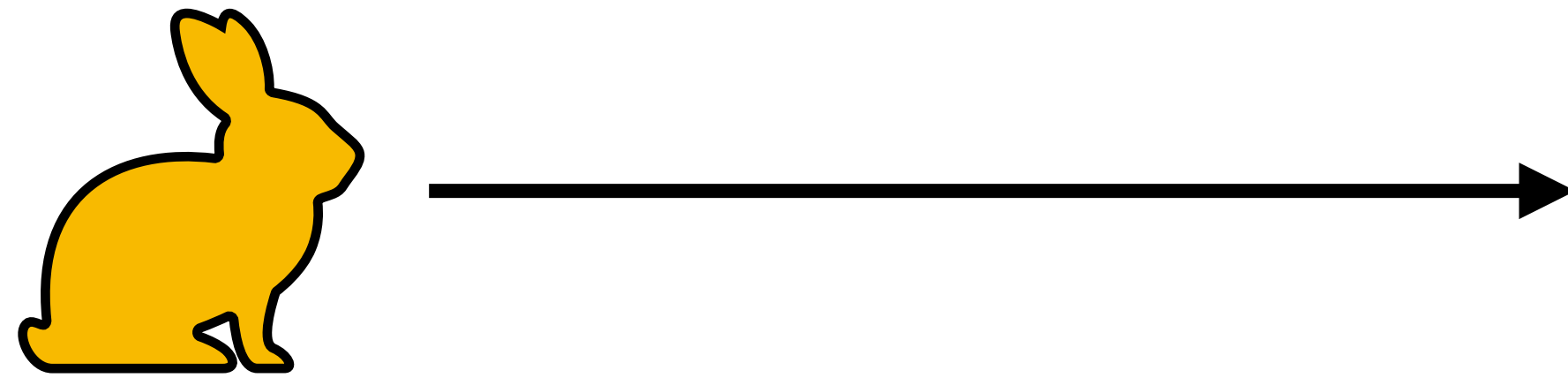

Eye Pursuit  
(Continuous)

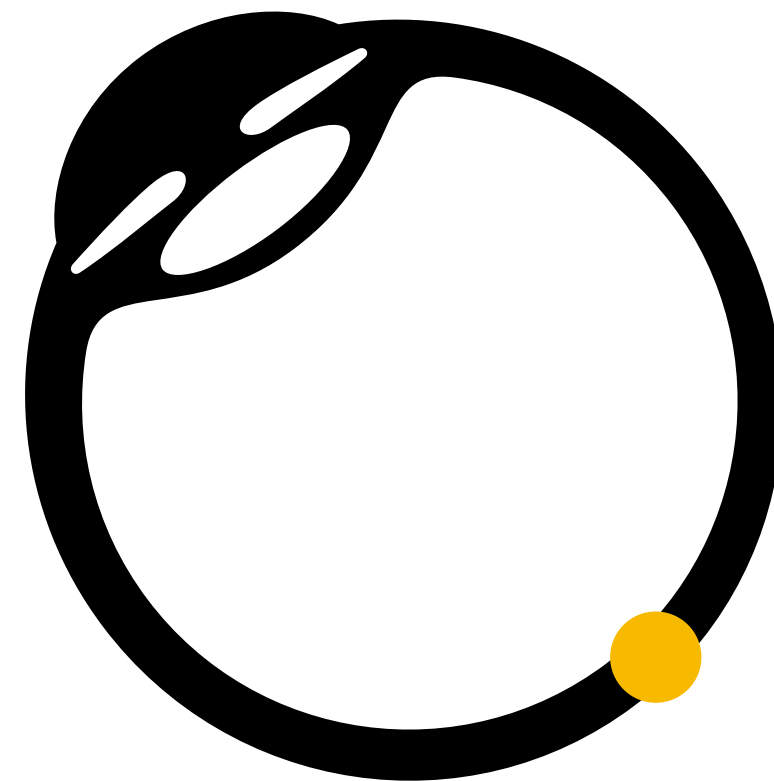

# Refresh Rate and Motion Blur

Displayed  
Frames  
(Discrete)

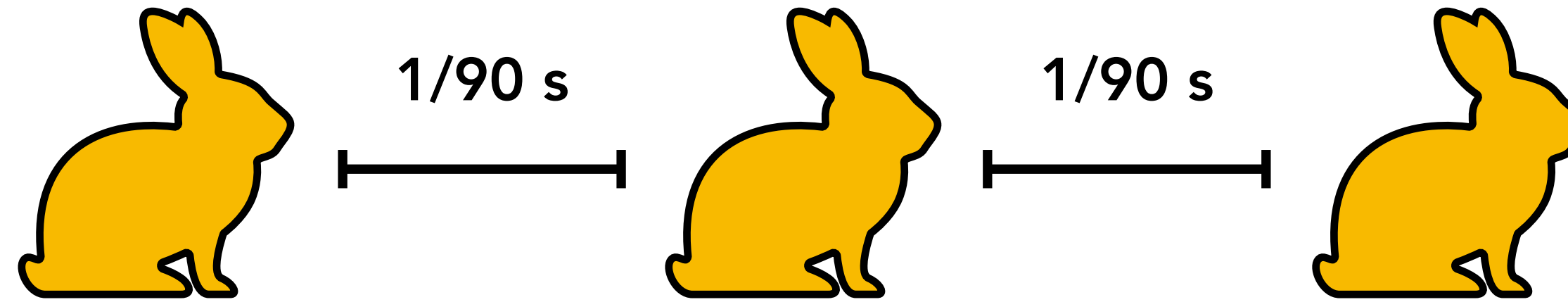

# Refresh Rate and Motion Blur

Displayed  
Frames  
(Discrete)

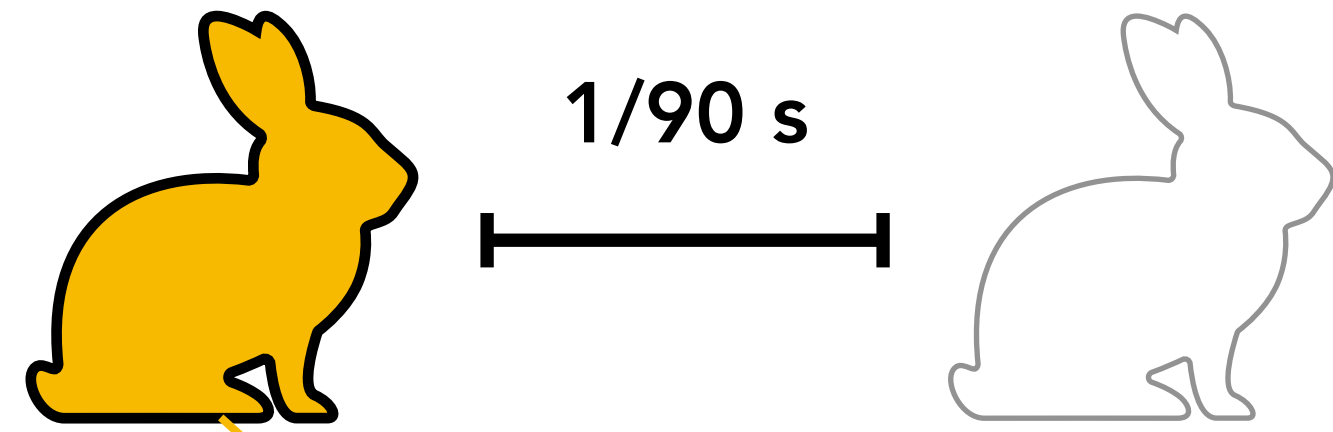

Eye Pursuit  
(Continuous)

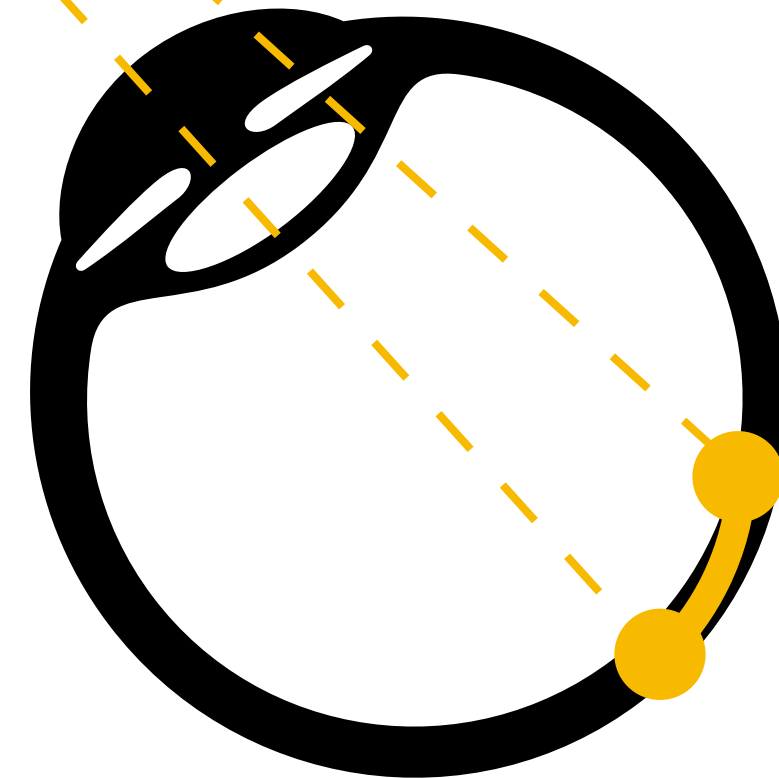

# Refresh Rate and Motion Blur

Caused by the “sample and hold” nature of displays. Your eyes tend to perform smooth pursuit but object appears on display in discrete locations.

The end result is the object smears across your retina — motion blur.

Fixes: reduce the size of the smear

- Increase the refresh rate (cons: power increase)
- Use “low-persistence” mode: for each refresh cycle display the image only for a short period of time with a black screen for the remaining time before next frame arrives (cons: lower brightness)

Variable-refresh-rate displays have been investigated.

# Sequential Color Displays

# Field Sequential Color (FSC)

Flash each primary at a high rate. Relies on **temporal integration** in human visual system, which fuses successive images into a color picture.

Color filtering array **spatially** adds colors; FSC **temporally** adds color.

Compared to using color filtering arrays:

- + 3X higher resolution if nothing else changes.
- + higher luminous efficacy (if not using filters).
- + manufacturing cost is lower.

Color filter array

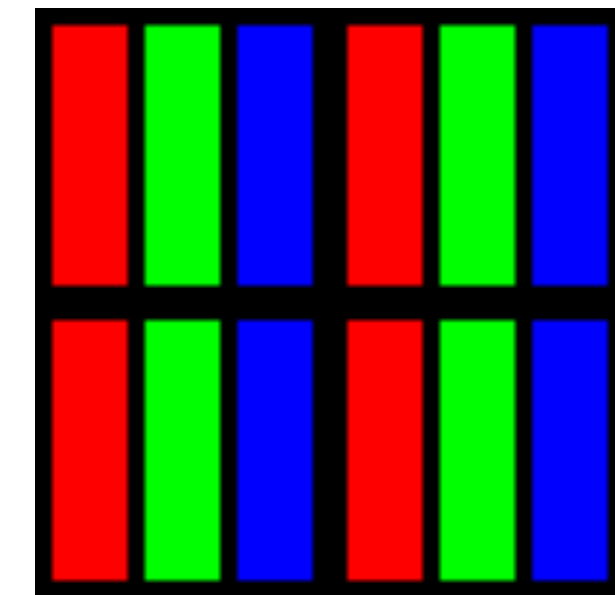

Color wheel

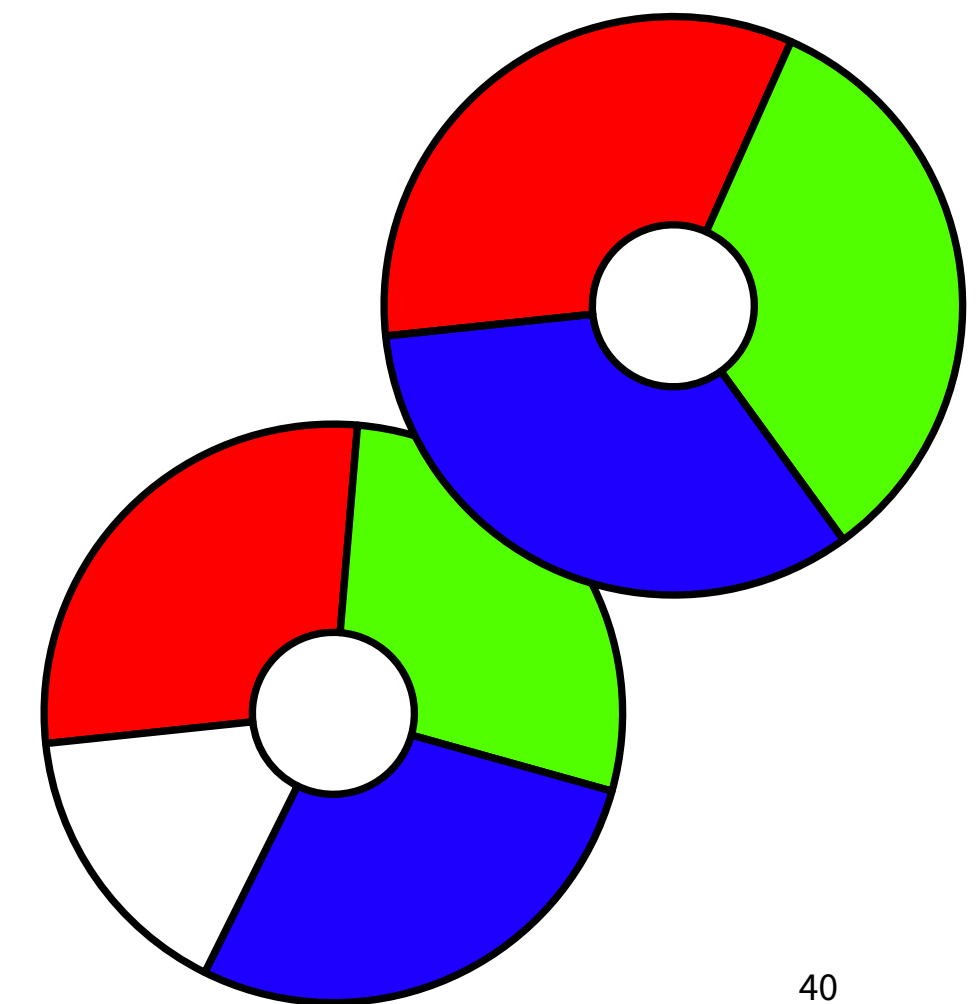

40

# CBS FSC TV System

CBS debuted the FSC TV system in 1940.

- Obsolete now. Watch a [video](#) demo.

24 rotations per second. Each color is scanned twice per rotation.

Transmitted images are black and white. Each image (also called a field) is unique and is in-sync with the color filter.

- Each B/W pixel encoded brightness.

$24 \times 6 = 144$  fields/s transmitted.





# FSC in Digital Light Processing (DLP) Projectors

DMD (created by TI at 1987)

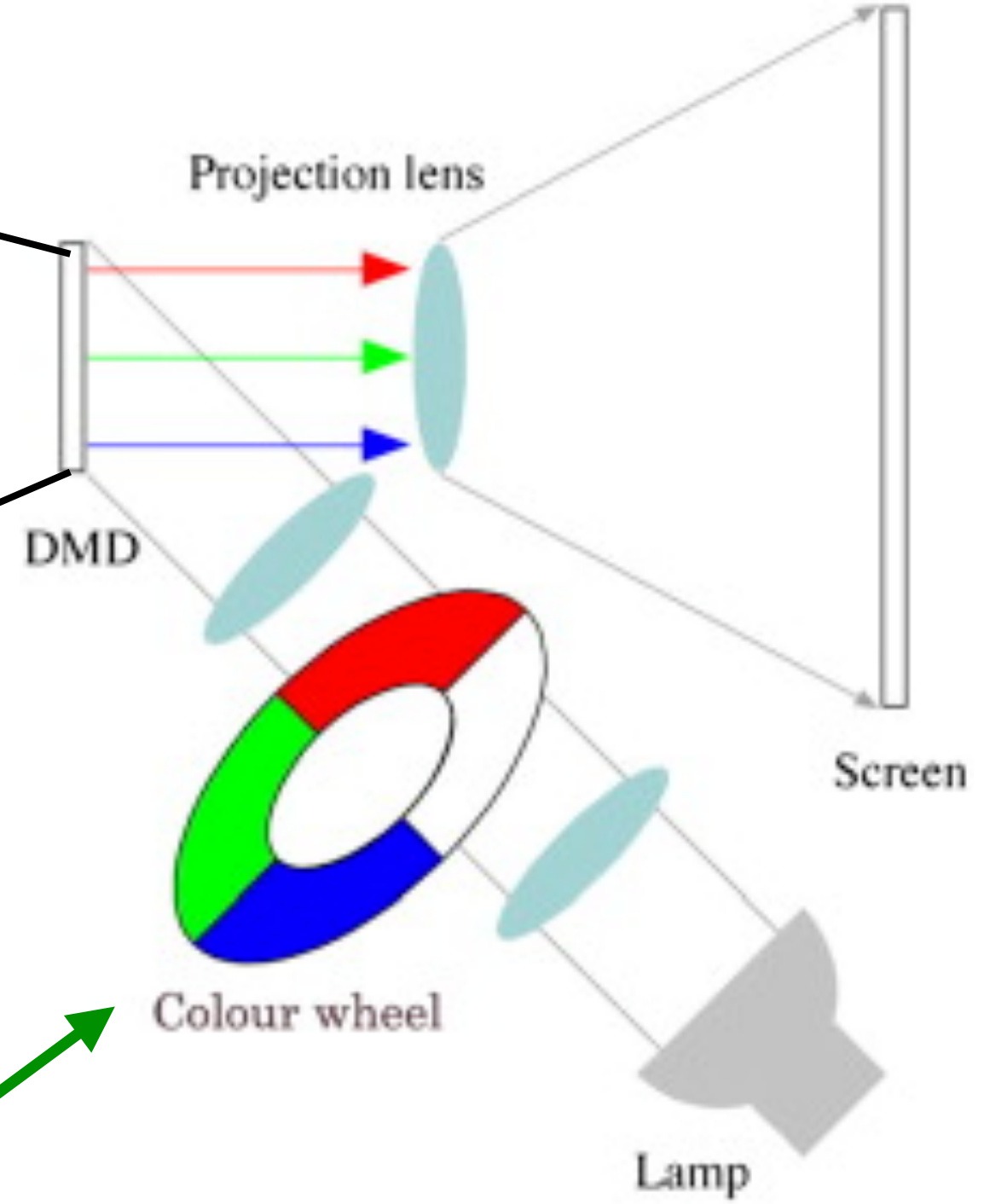
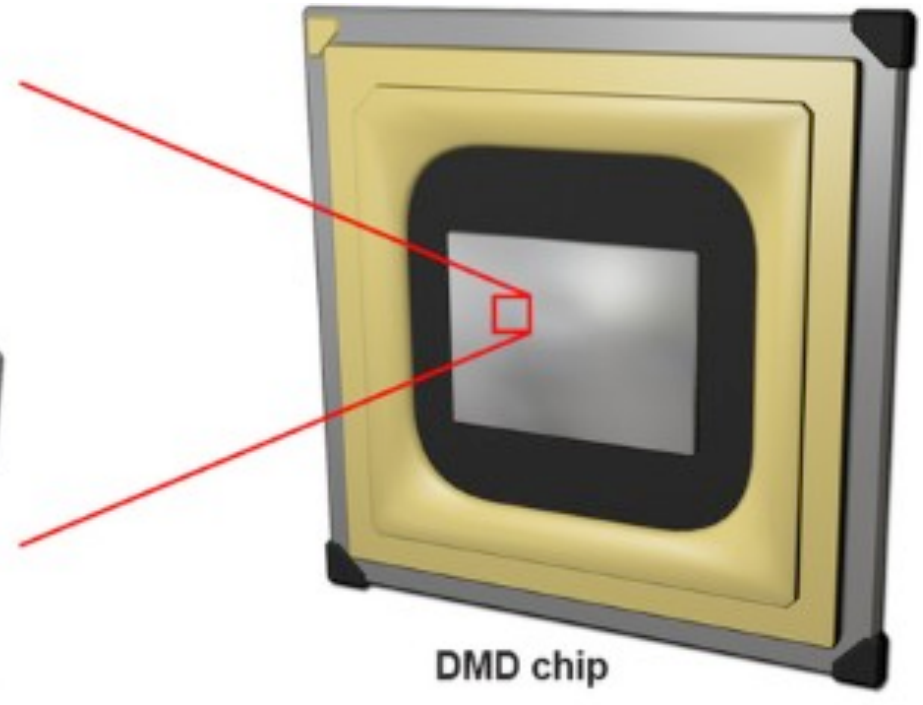
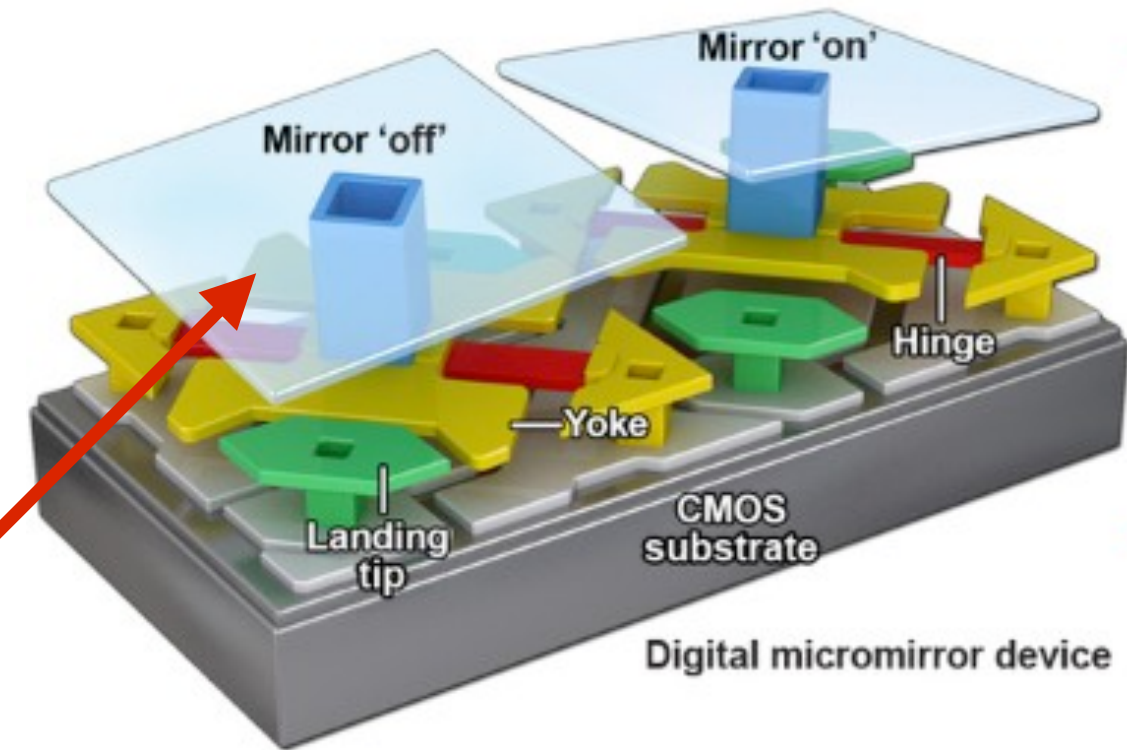

Per-pixel mirror controls the brightness of light at each pixel. "Off" means the mirror reflects light away from the lens. A mirror can be switch between on/off thousands of times a second and with ~1024 levels (resolution).

The spinning color wheel (only 1 in the projector) controls the color of each pixel.

The mirror orientation and the color wheel rotation must be perfectly in-sync. ~10 spin/s.



1998 InFocus LP425z

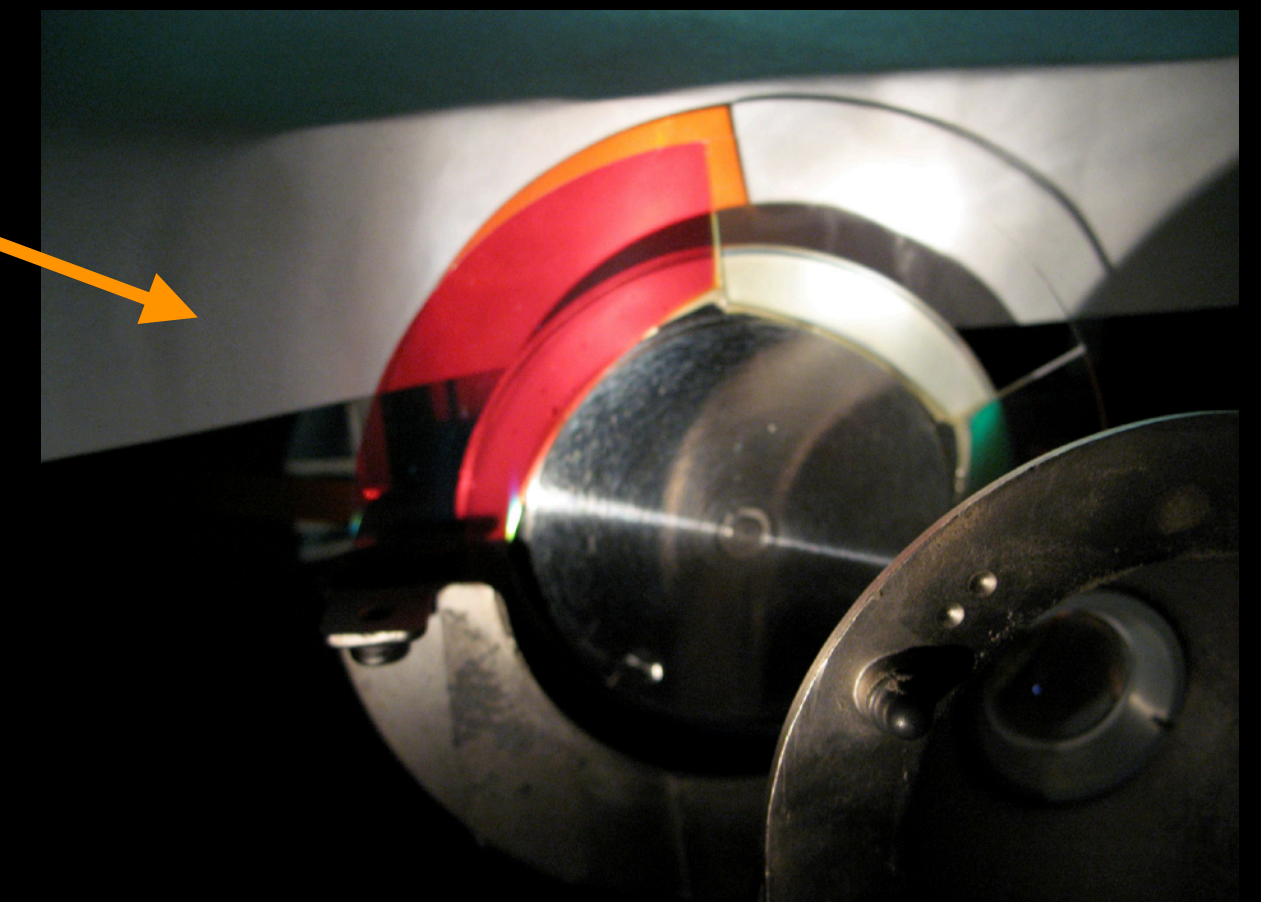
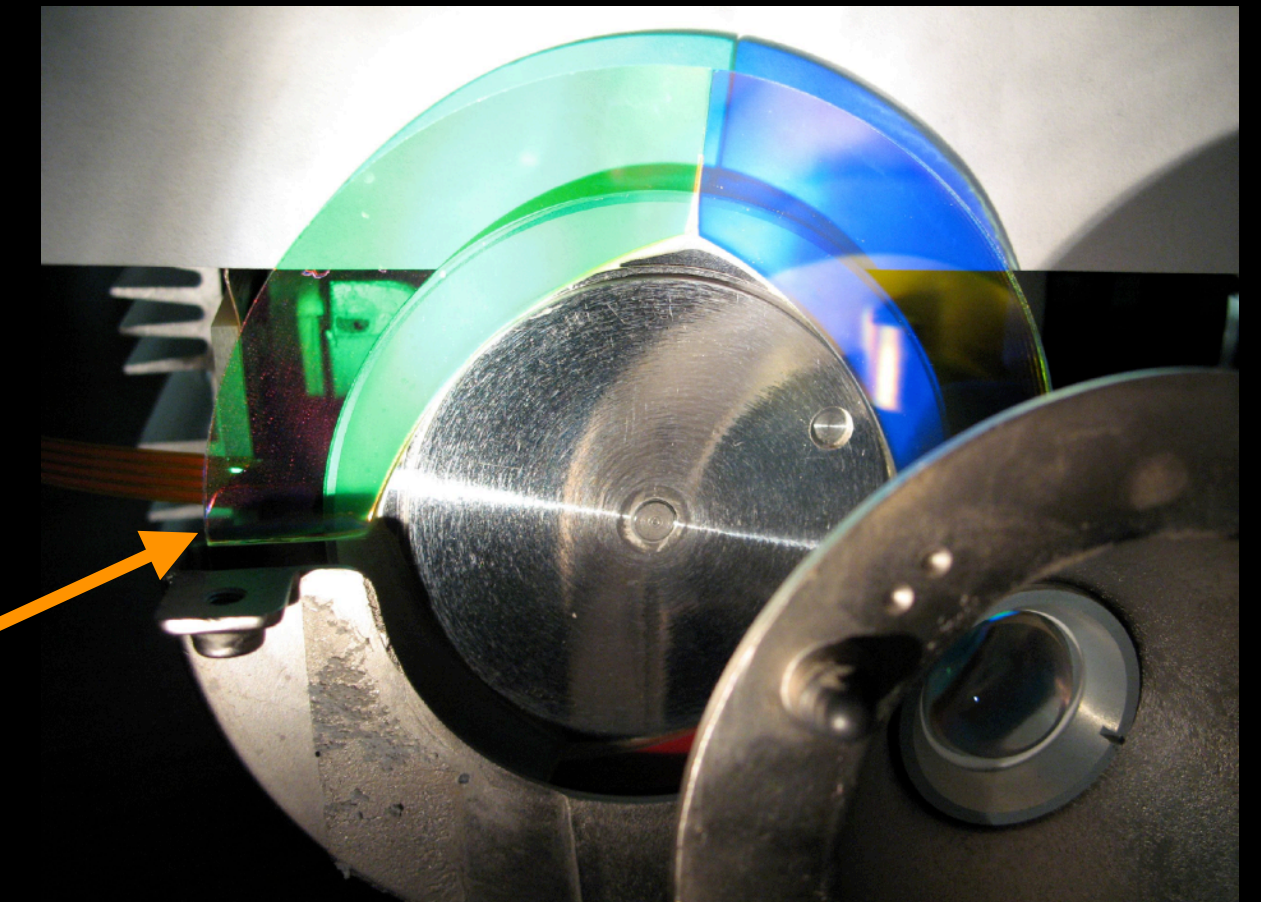
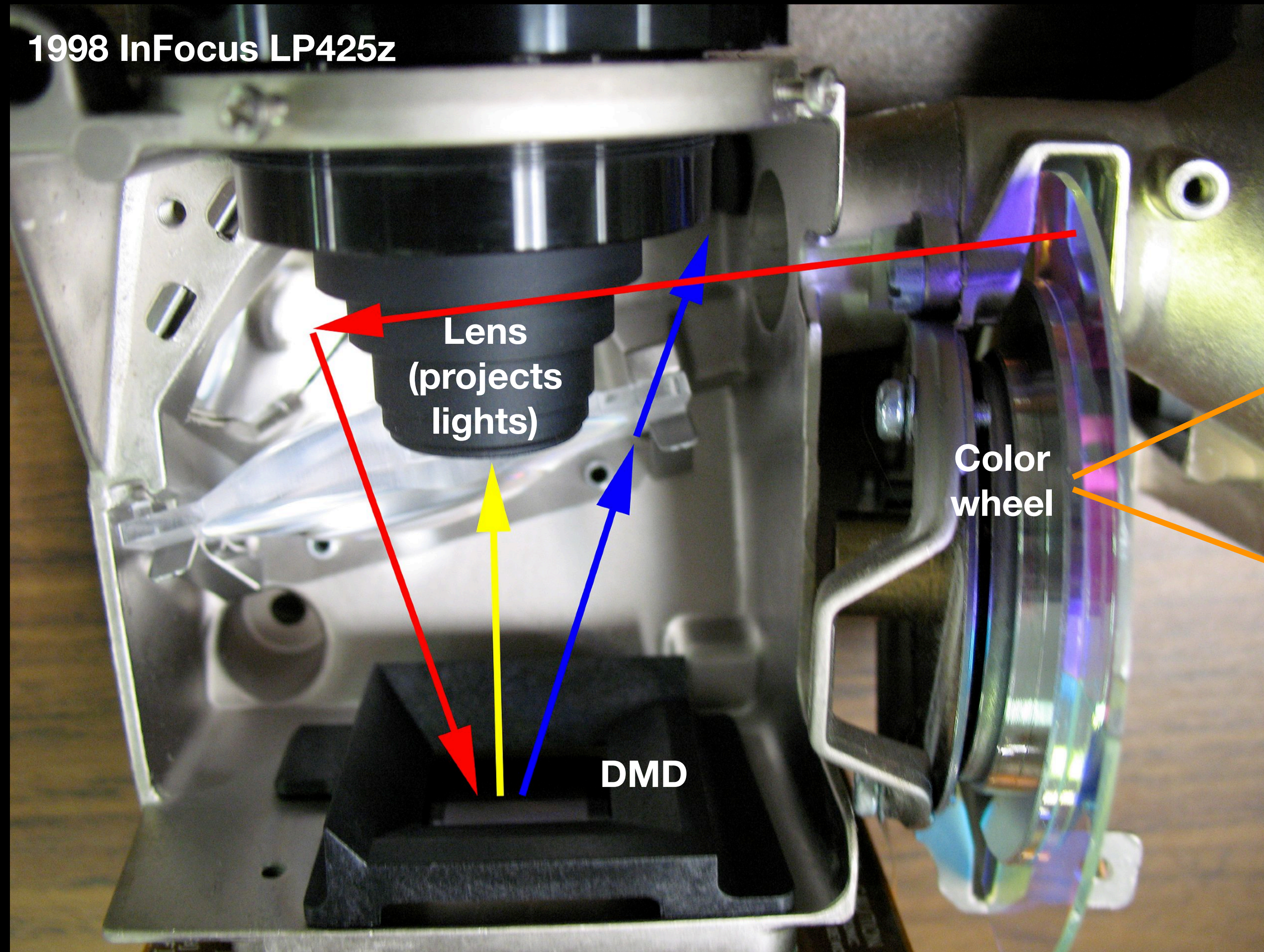

# Color Breakup in FSC

Are your eyes are tracking a moving object the three color channels of the same object are sequentially captured on retina.

- In spirit similar to motion blur from low refresh rate.

A good explanation [here](#).

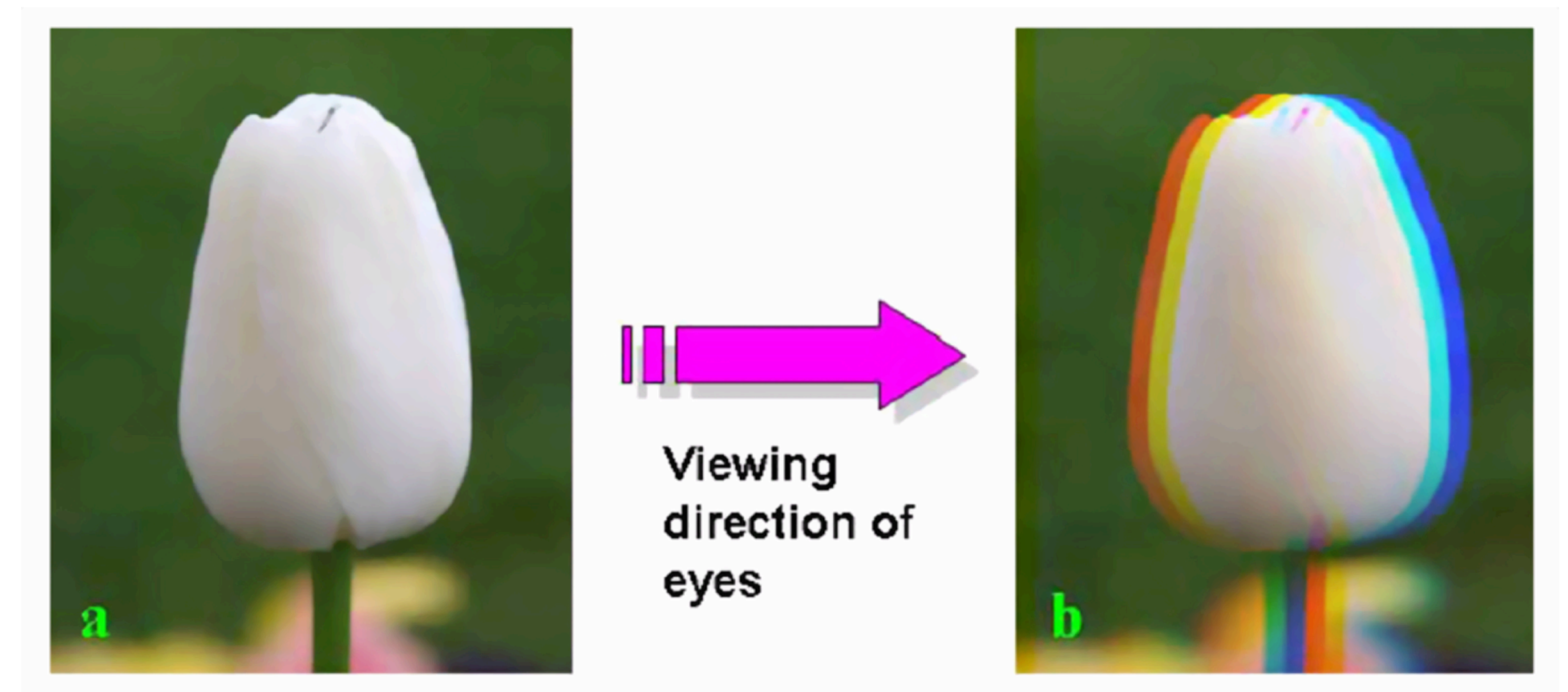
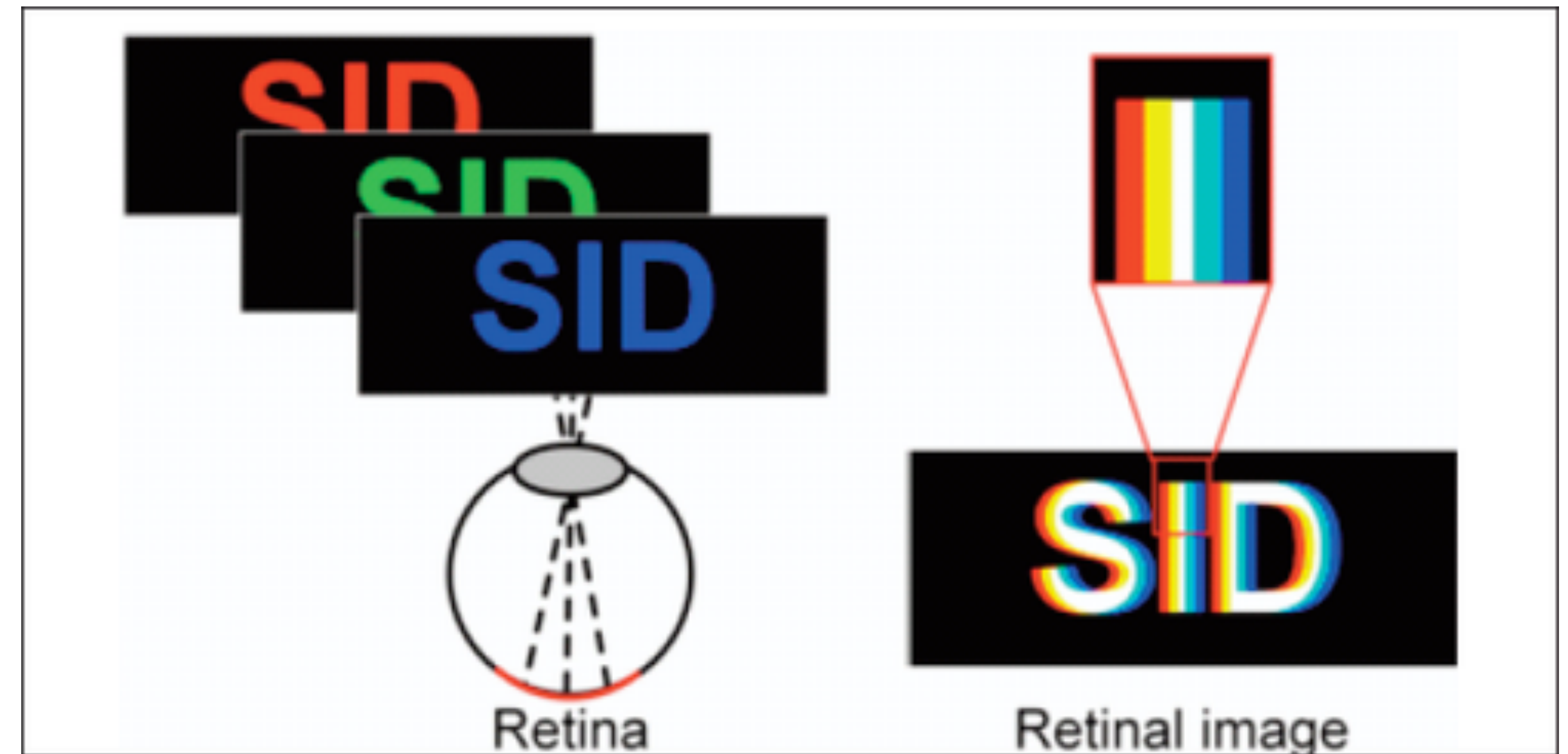

# **“Intensity” and Dynamic Range**

# Intuition

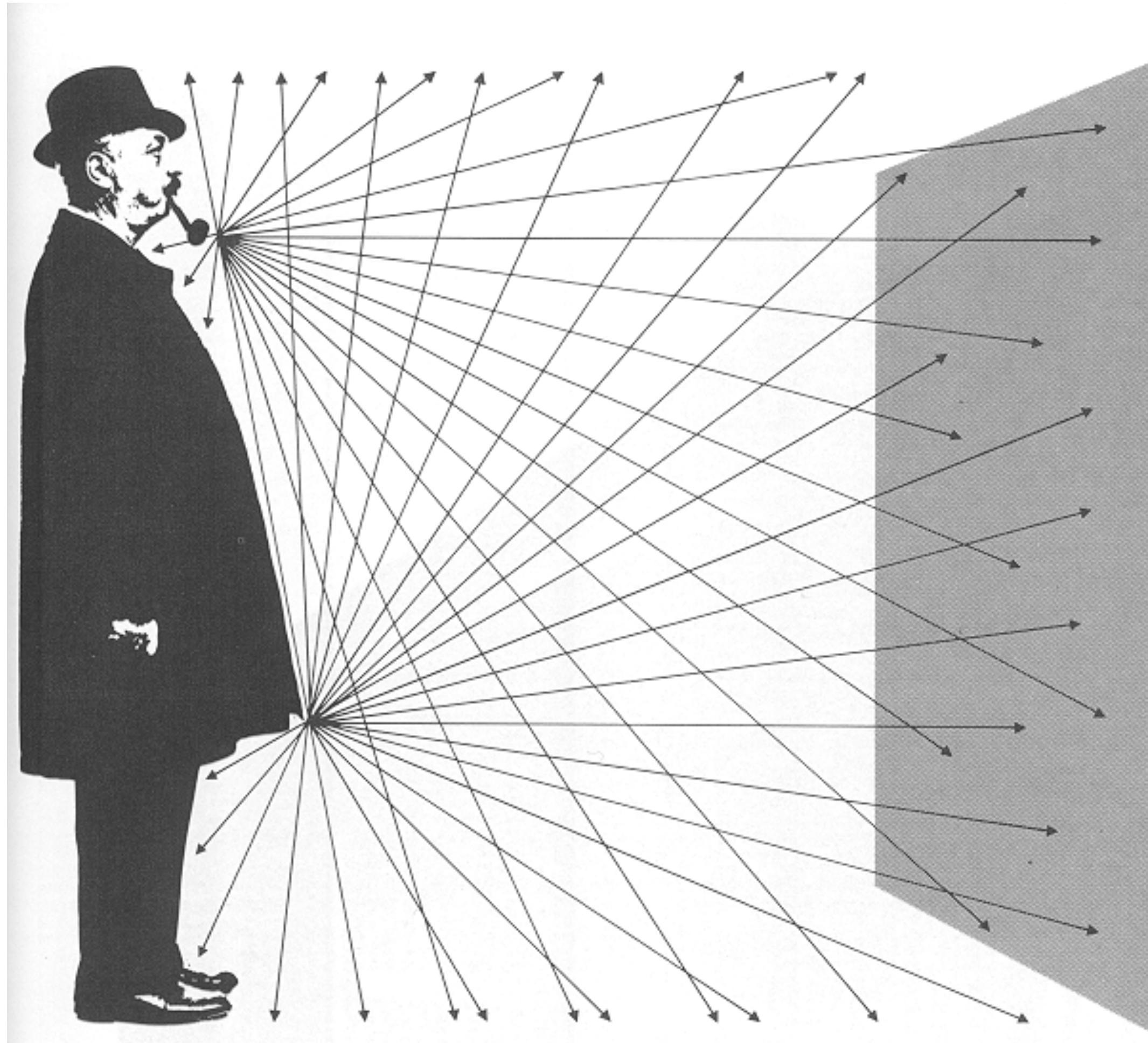

From London and Upton

So far we have been using power to describe light's intensity.

- Power is **all** the light energy received/emitted per unit time

But there are other more specific metrics we care about:

# Intuition

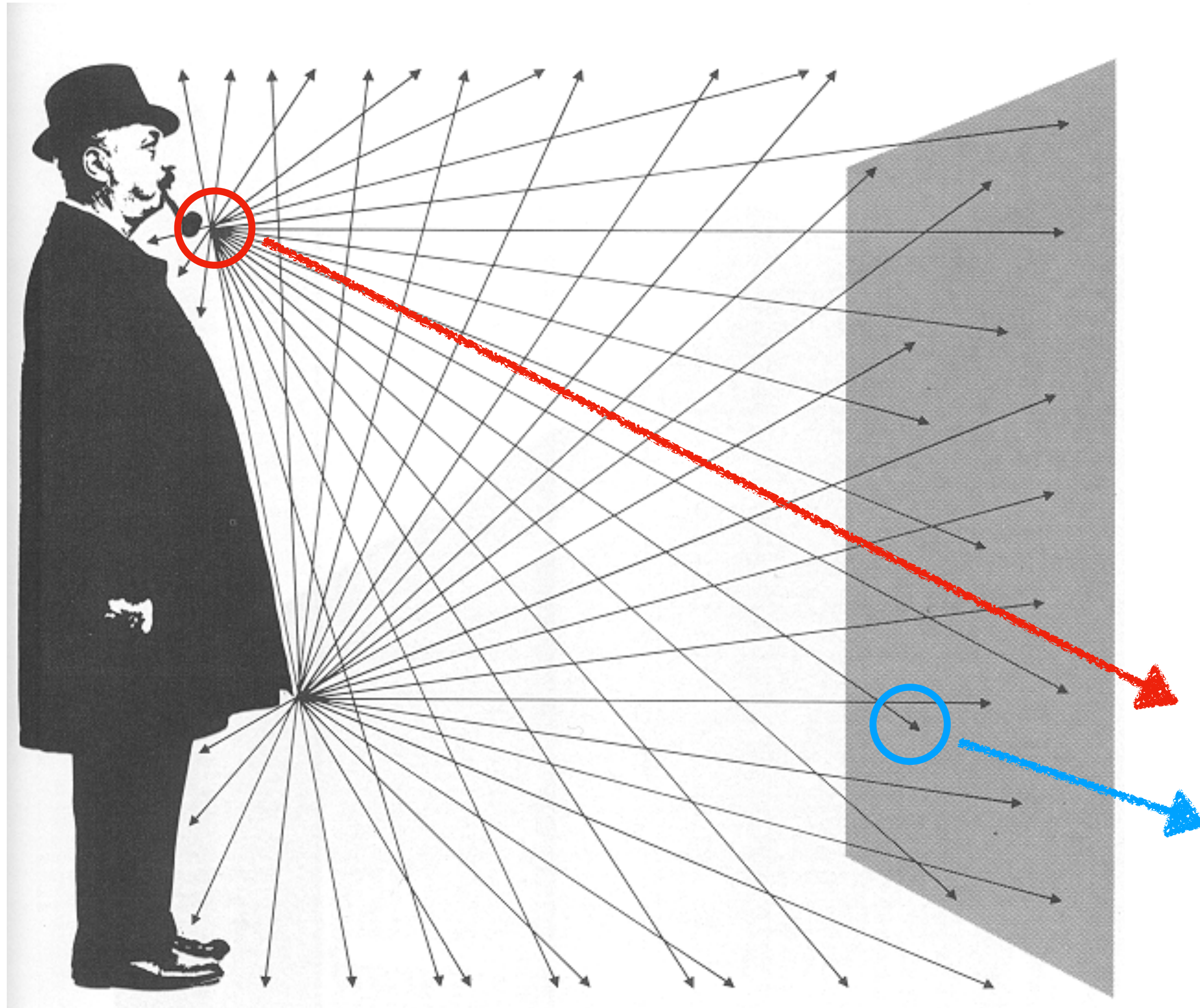

From London and Upton

So far we have been using power to describe light's intensity.

- Power is **all** the light energy received/emitted per unit time

But there are other more specific metrics we care about:

- Light emitted/received at a single point?
- Light emitted/received at a single point along a single ray?

# Irradiance vs. Radiance

\* Note: just like power is wavelength dependent, so are irradiance and radiance. We will generally omit the wavelength symbol for simplicity.

So far we have been using power to describe light's intensity.

- Power is **all** the light energy received/emitted per unit time

But there are other more specific metrics we care about:

- Light emitted/received at a single point?
- Light emitted/received at a single point along a single ray?

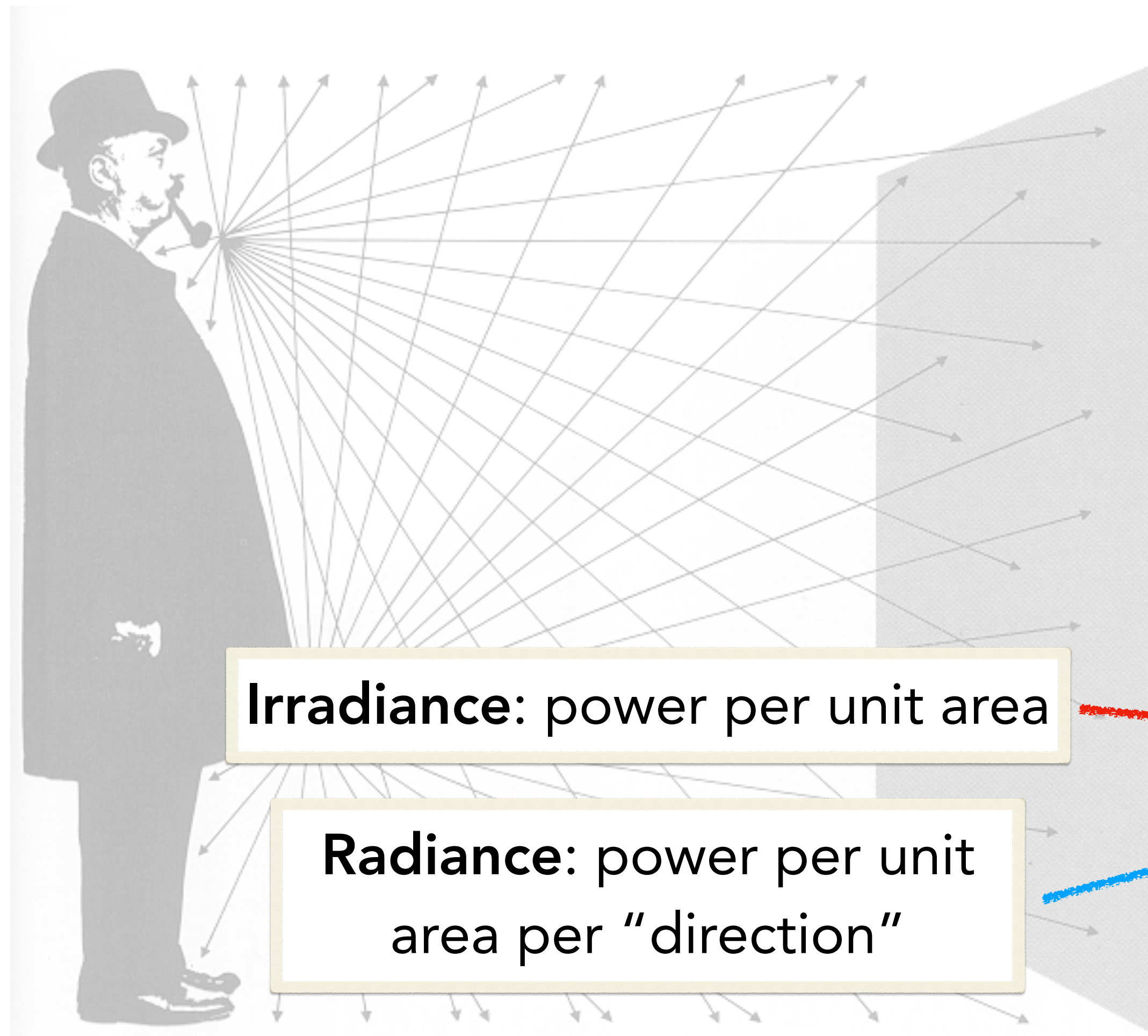

**Irradiance:** power per unit area

**Radiance:** power per unit area per "direction"

From London and Upton

# Power vs. Luminous Flux

LEF: inversely proportional to the power needed at each wavelength to produce same level of neural response (brightness).

- The constant 683 is to normalize to historical standards.

Power (unit: **watt**) weighted by LEF is called luminous flux (unit: **lumen**).

$$\Phi_v(\lambda) = 683 \frac{\text{lm}}{\text{W}} \Phi_e(\lambda) V(\lambda)$$

Luminous flux  
Unit: **lm**

Power (radiant flux)  
Unit: **W**

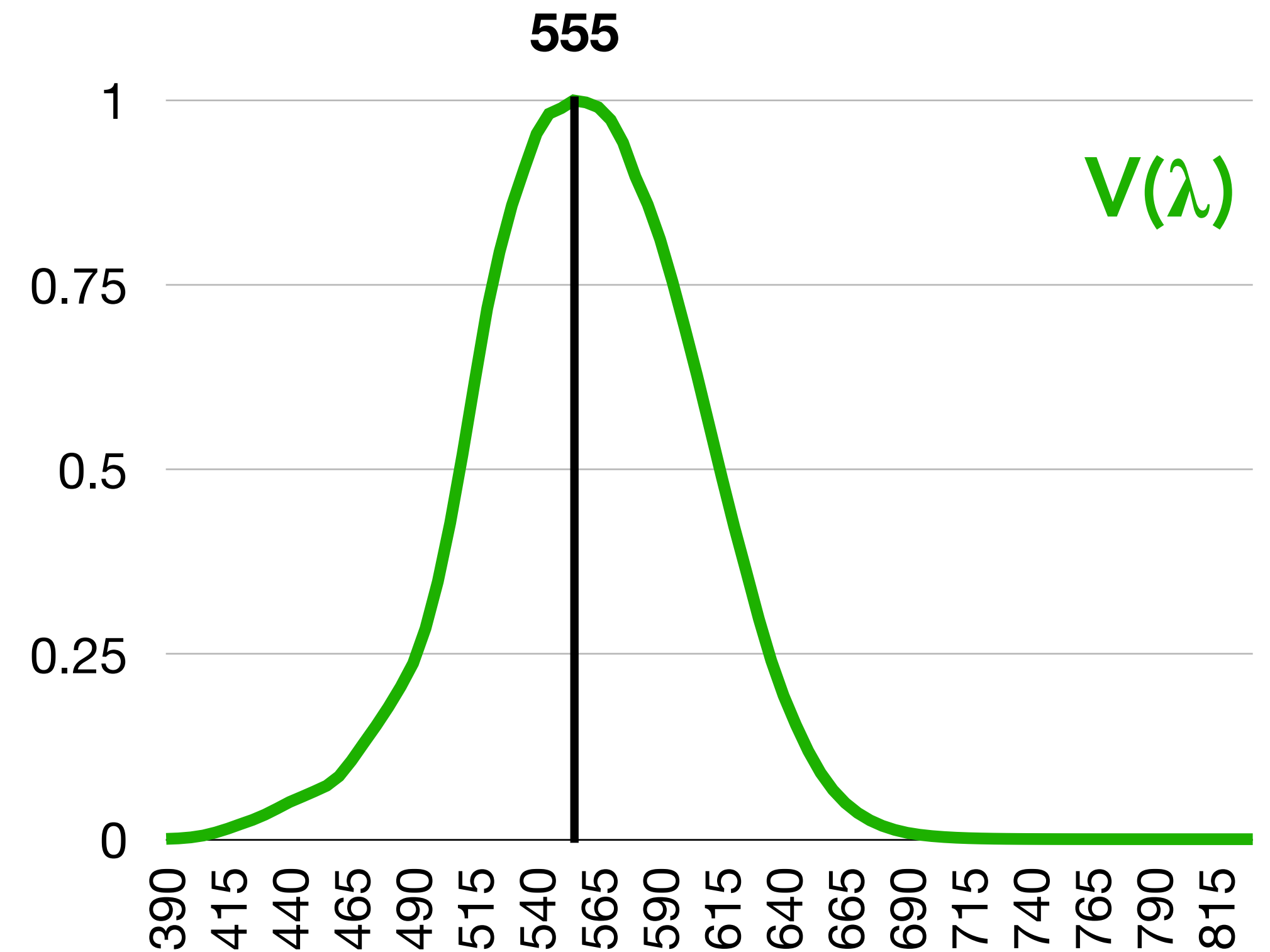

**CIE 2008 Photopic LEF**



# Irradiance = Power Per Unit Area (W/m<sup>2</sup>)



$$E_e = \frac{d\Phi_e}{dA}$$

Irradiance  
Unit: **W/m<sup>2</sup>**

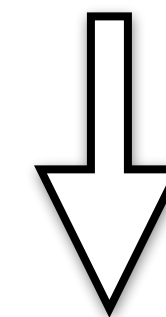

Illuminance  
Unit: **lux = lm/m<sup>2</sup>**

Power (radiant flux)  
Unit: **W**

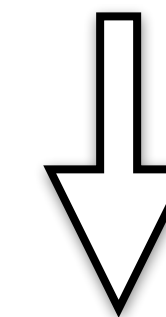

Weighted by LEF

Luminous flux  
Unit: **lm**

# Irradiance Falls Off With Incident Angle

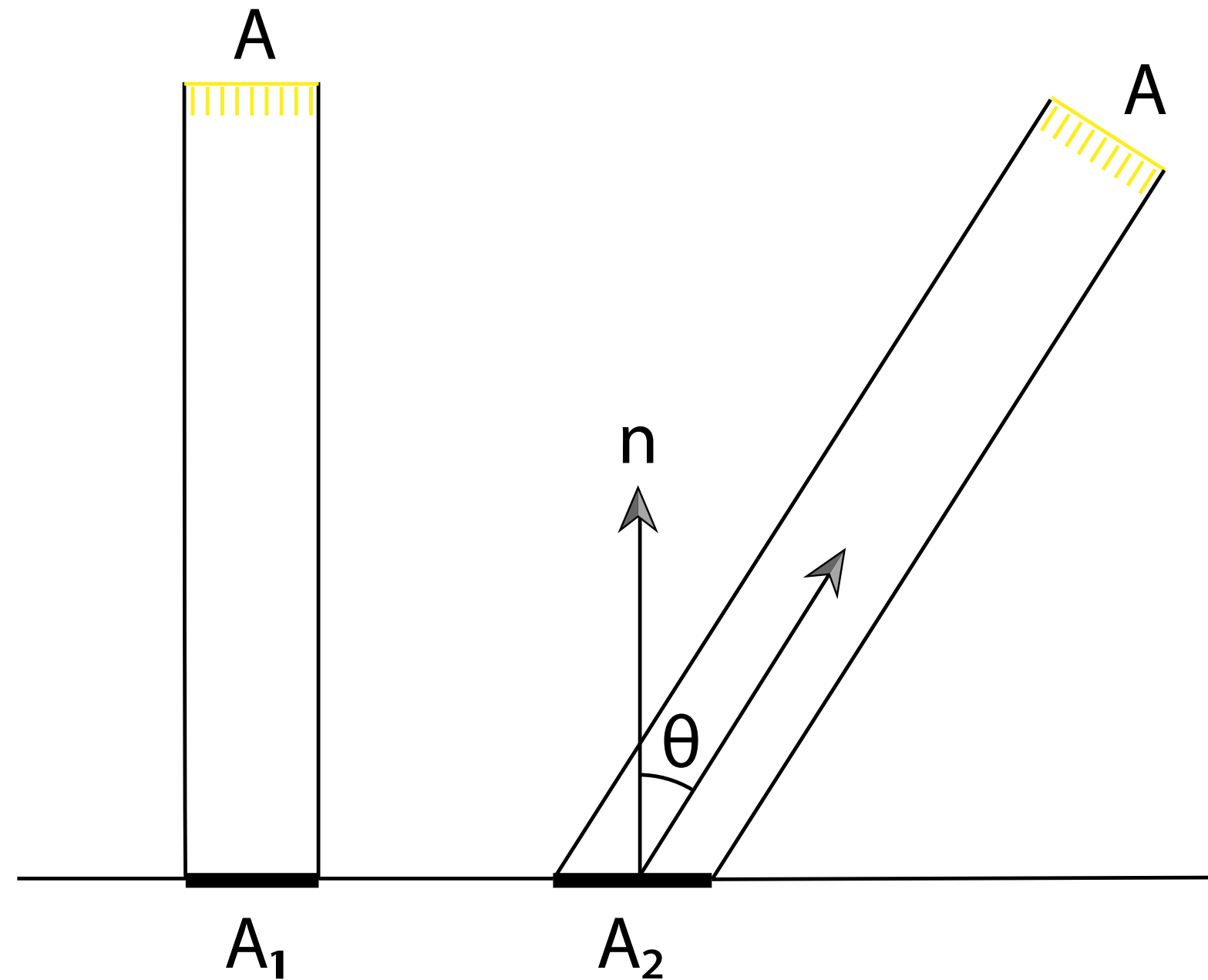

$$E_{e,1} = \frac{d\Phi_e}{dA_1}$$

$$E_{e,2} = \frac{d\Phi_e}{dA_2} = \frac{d\Phi_e \cos \theta}{dA_2}$$

Intuition is that the incident photons get smeared across a larger area as incident angle increases. Extreme case: incident light is parallel to the surface, in which case the surface irradiance is 0.

# That's Why We Have Seasons!

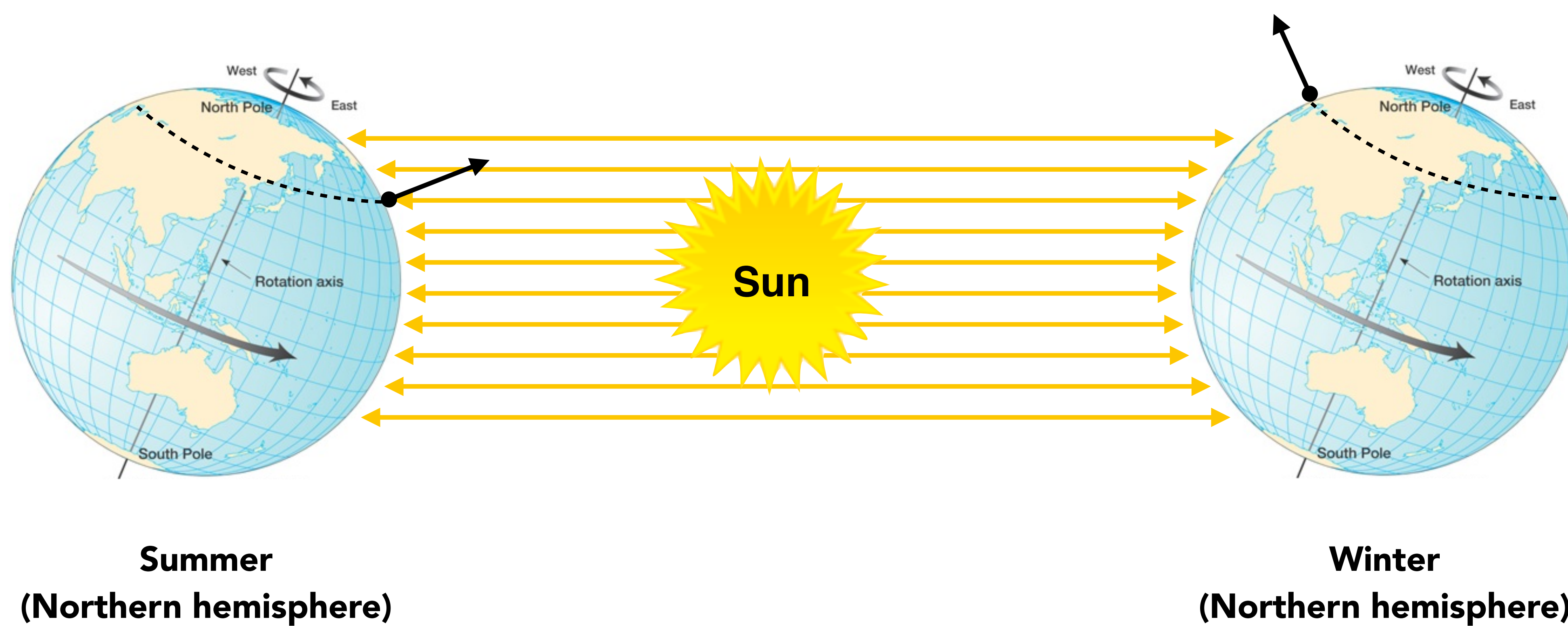

[Image credit: Pearson Prentice Hall]

**Earth's axis of rotation:  $\sim 23.5^\circ$  off axis**

# Irradiance Falls Off With Distance

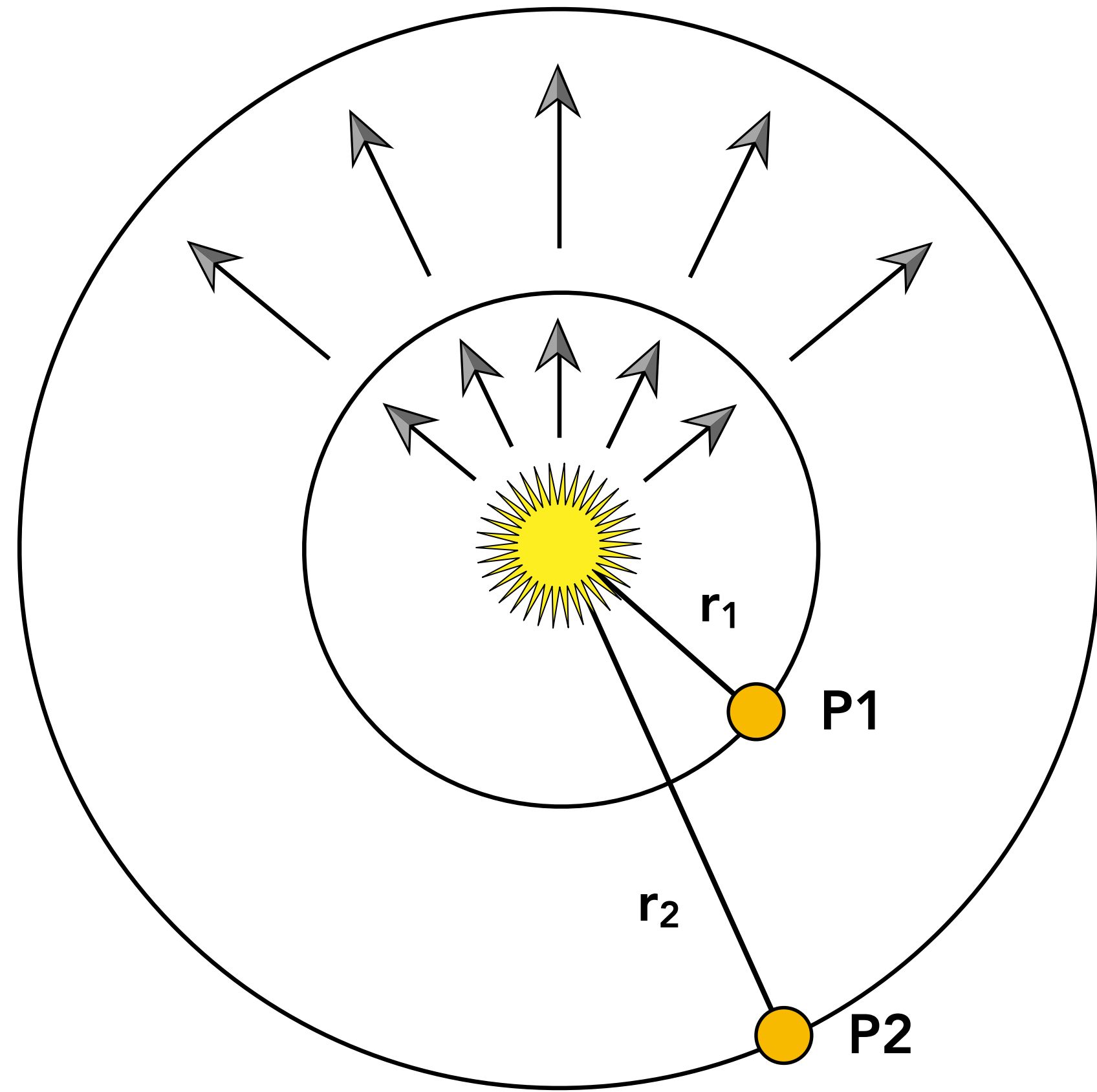

$$E_{e,1} = \frac{\Phi_e}{4\pi r_1^2} \quad E_{e,2} = \frac{\Phi_e}{4\pi r_2^2}$$

Irradiance falls off quadratically with respect to distance.

Intuition: the same amount of photons emitted from the light source gets smeared across a larger surface area as distance increases.

# How to Describe Direction?

## Angles and Solid Angles

Angle: ratio of subtended arc length on circle to radius

- $\theta = \frac{l}{r}$
- Circle has  $2\pi$  **radians**

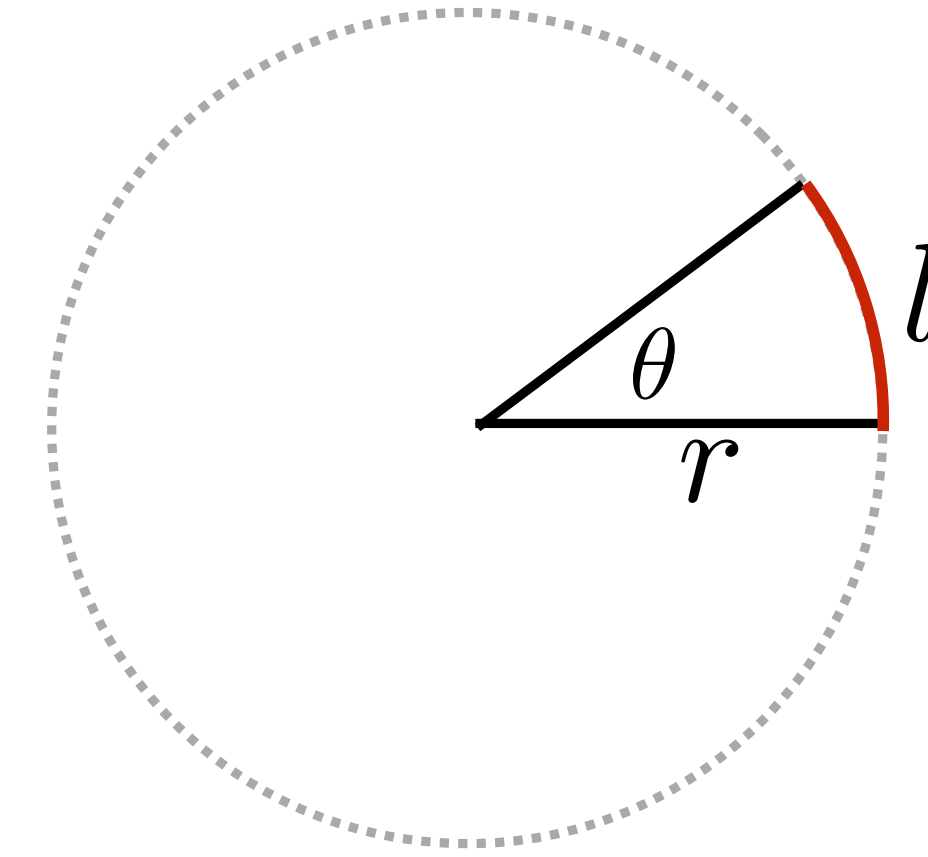

Solid angle: ratio of subtended area on sphere to radius squared

- $\Omega = \frac{A}{r^2}$
- Sphere has  $4\pi$  **steradians**

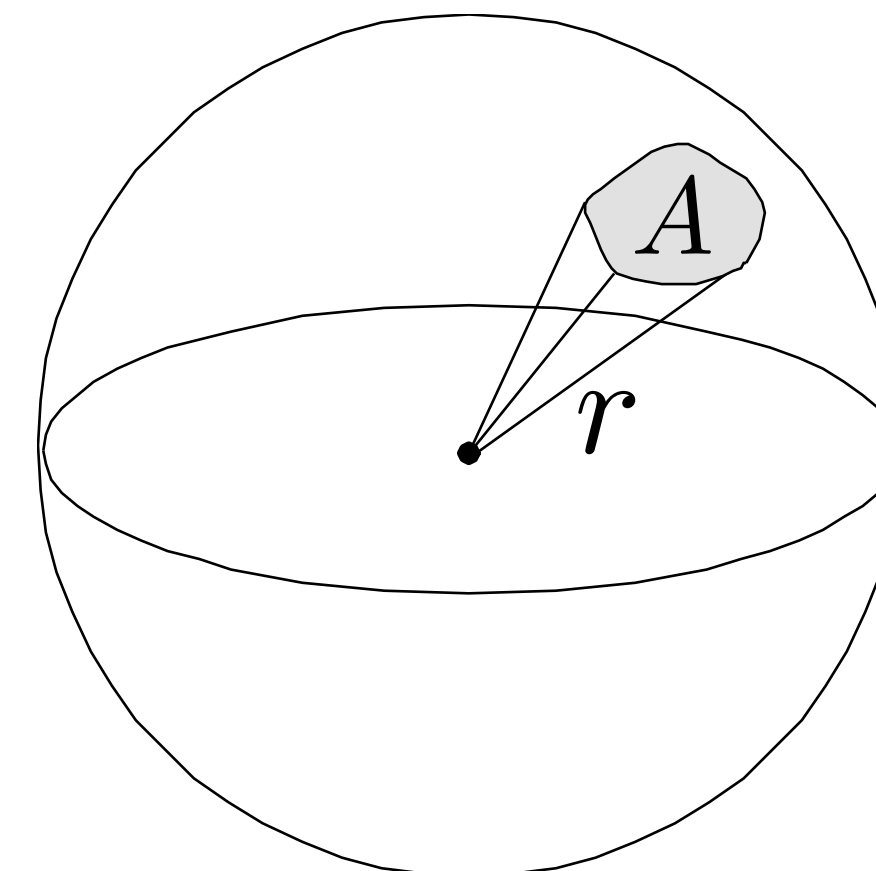

# Radiance = Irradiance Per Unit Solid Angle

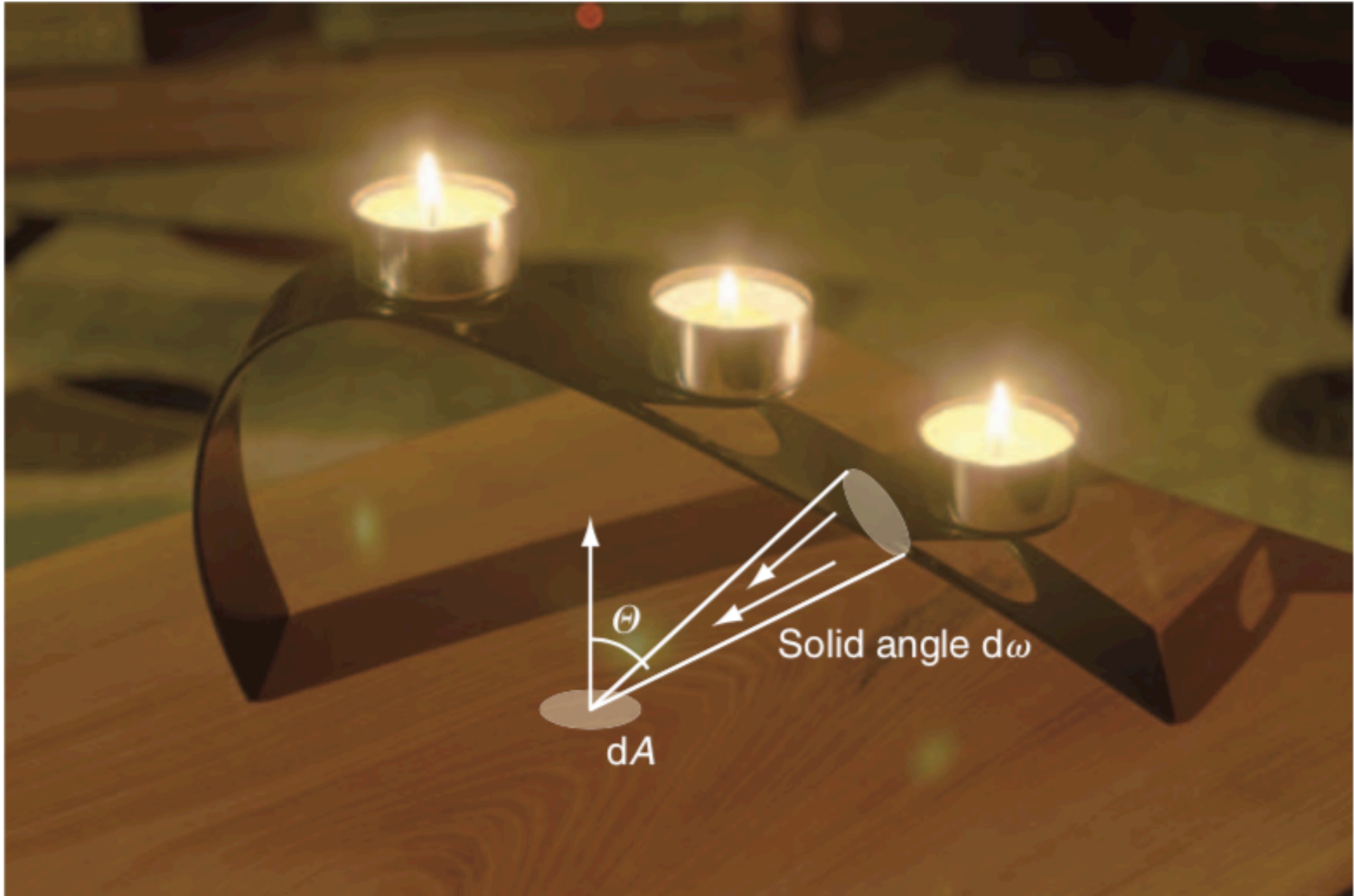

\* radiance is defined at the projected area  $dA^\perp$ , rather than  $dA$ .

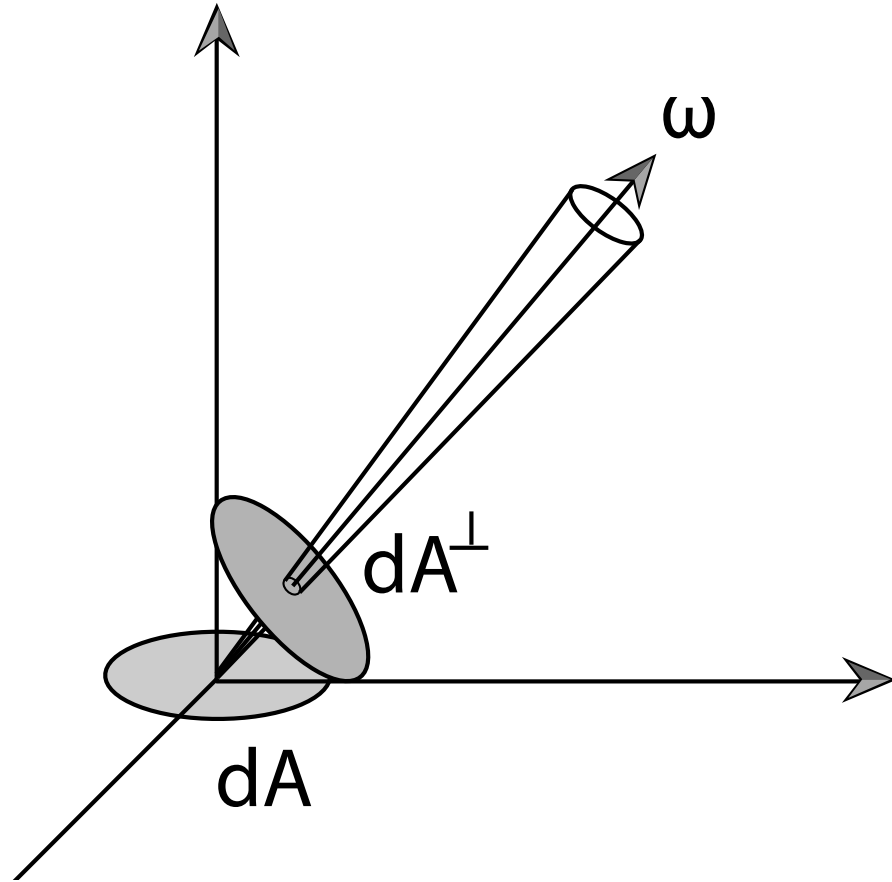

$$L_e = \frac{dE_e}{d\omega} = \frac{d^2\Phi_e}{d\omega dA^\perp} = \frac{d^2\Phi_e}{d\omega dA \cos \theta}$$

Radiance  
Unit: **W/(sr m<sup>2</sup>)**

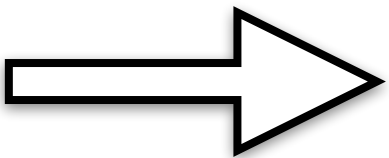

Luminance  
Unit: **nit = lm/(sr m<sup>2</sup>) = cd/m<sup>2</sup>**

Weighted by LEF

# Radiometry vs. Photometry

**Radiometry** Units

Power (radiant flux)  
Unit: **W**

Irradiance  
Unit: **W/m<sup>2</sup>**

Radiance  
Unit: **W/(sr m<sup>2</sup>)**

Weighted by LEF

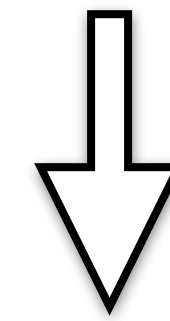
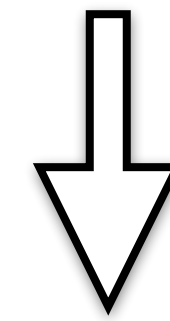
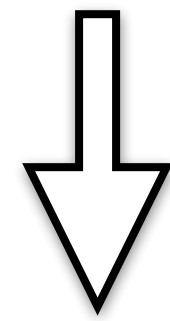

**Photometry** Units

Luminous flux  
Unit: **lm**

Illuminance  
Unit: **lux = lm/m<sup>2</sup>**

Luminance  
Unit: **nit = lm/(sr m<sup>2</sup>) = cd/m<sup>2</sup>**

# Radiance is Usually What We Care About

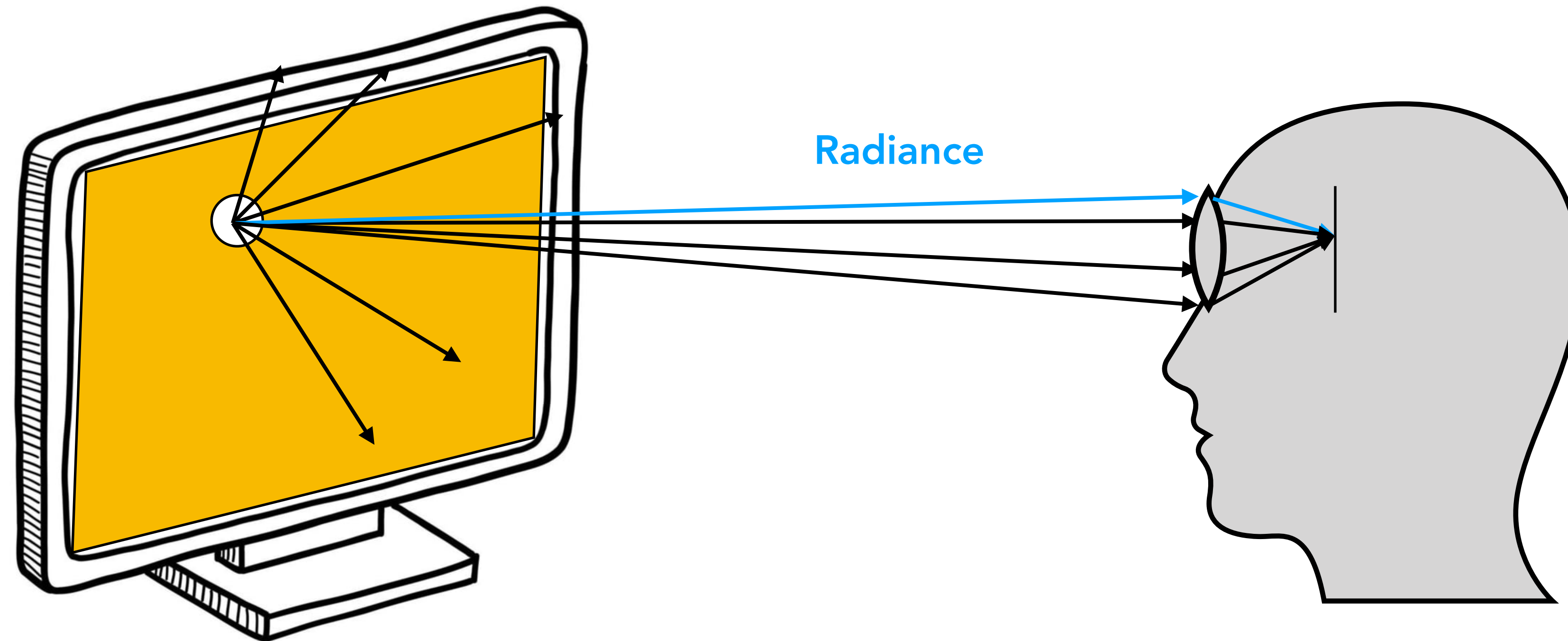

Each point on the display is emitting lights to the entire hemisphere, but only a small bundle of rays from each pixel actually enter our eyes/camera system.

- From radiance and the angle subtended by the eye we can calculate the irradiance of any point on the retina and the power of any photoreceptor/pixel given its area.



# Display Luminance



LG 27UK850-W (LCD): **350** nits



iPhone 14 (OLED): **1000** nits  
(2000 nits max)



Pixel 7 (OLED): **600** nits  
(1,000 nits max)

# Luminance in Natural Scenes

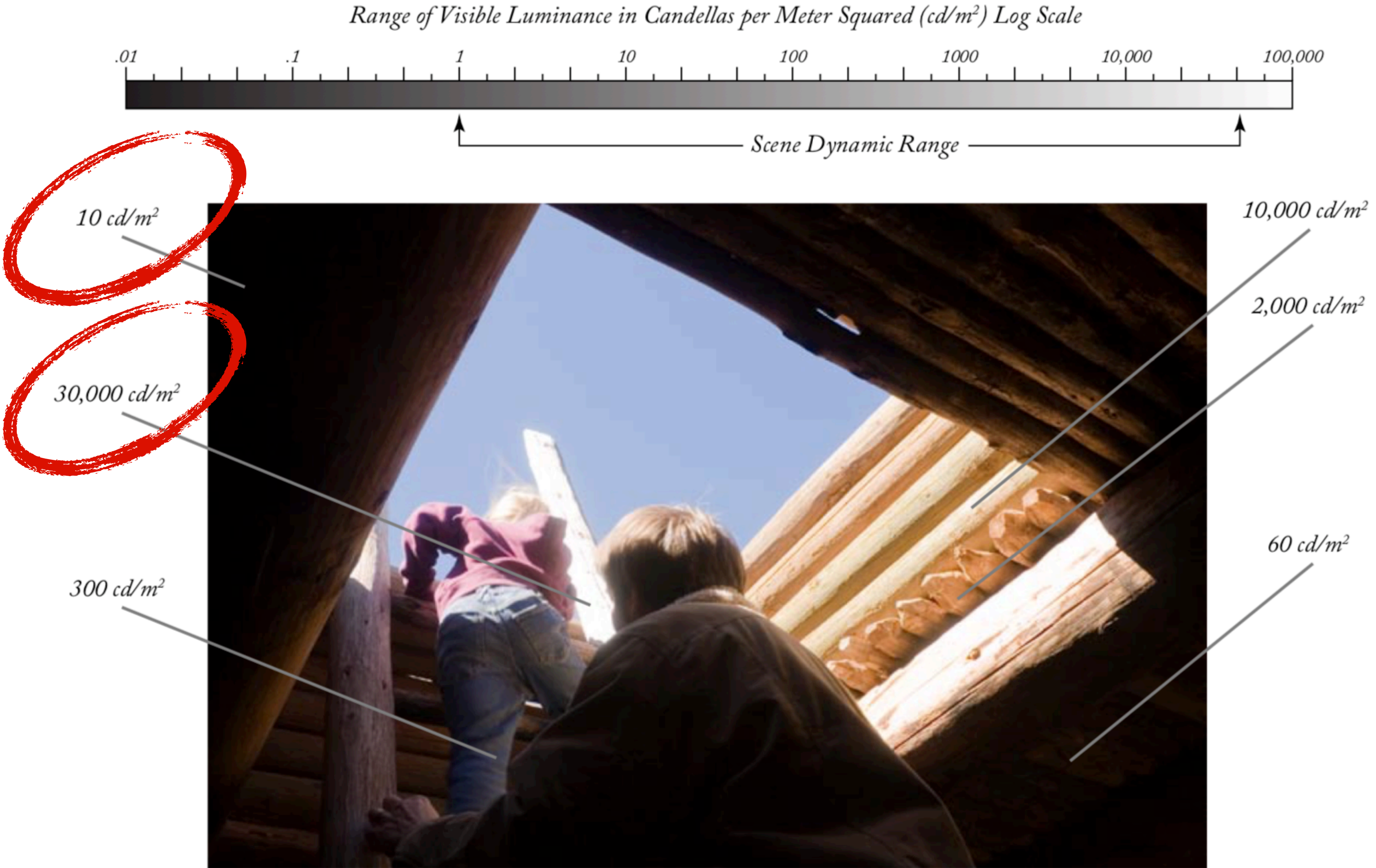

# Dynamic Range = Max Luminance / Min Luminance

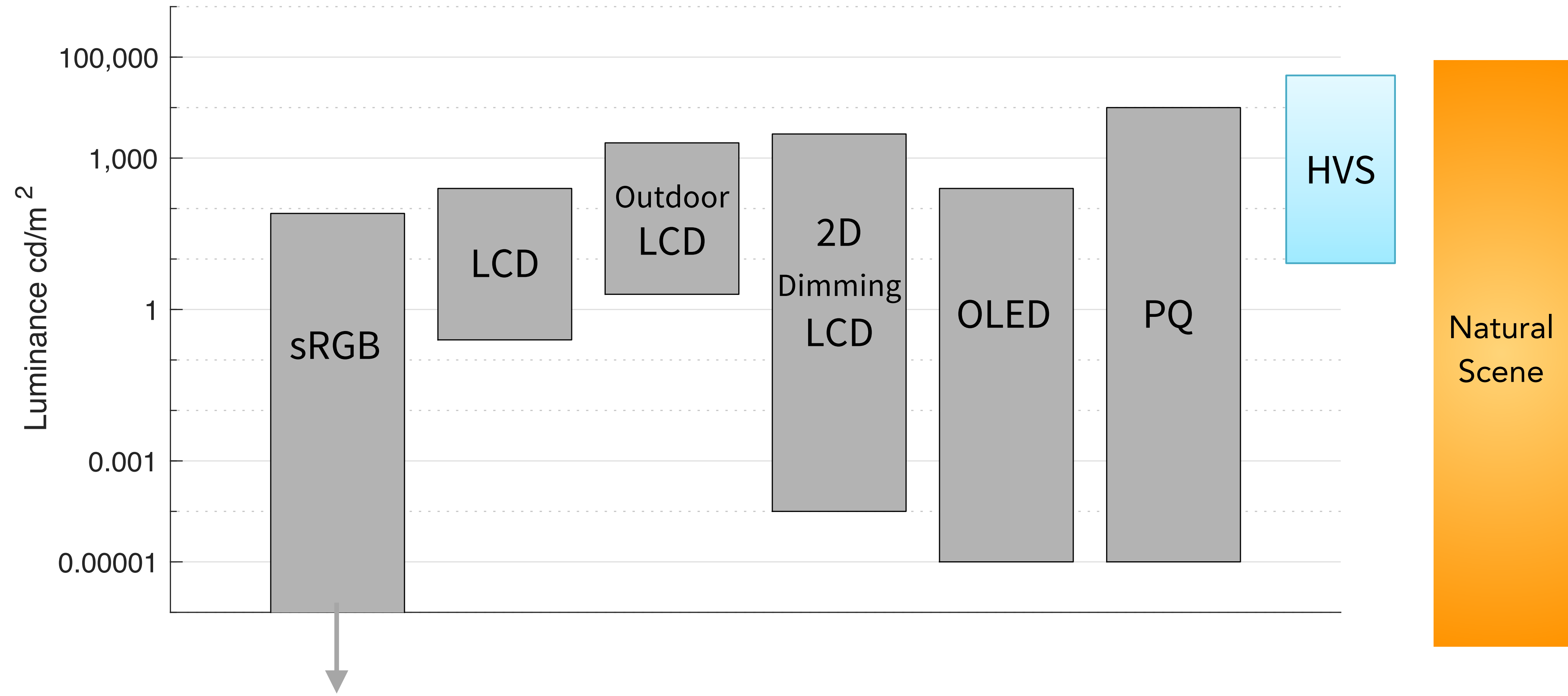

# Automatic Brightness

When external illumination is high, increase the display luminance because: 1) unwanted reflectance from display is high and 2) your eye "exposure time" is shorter.

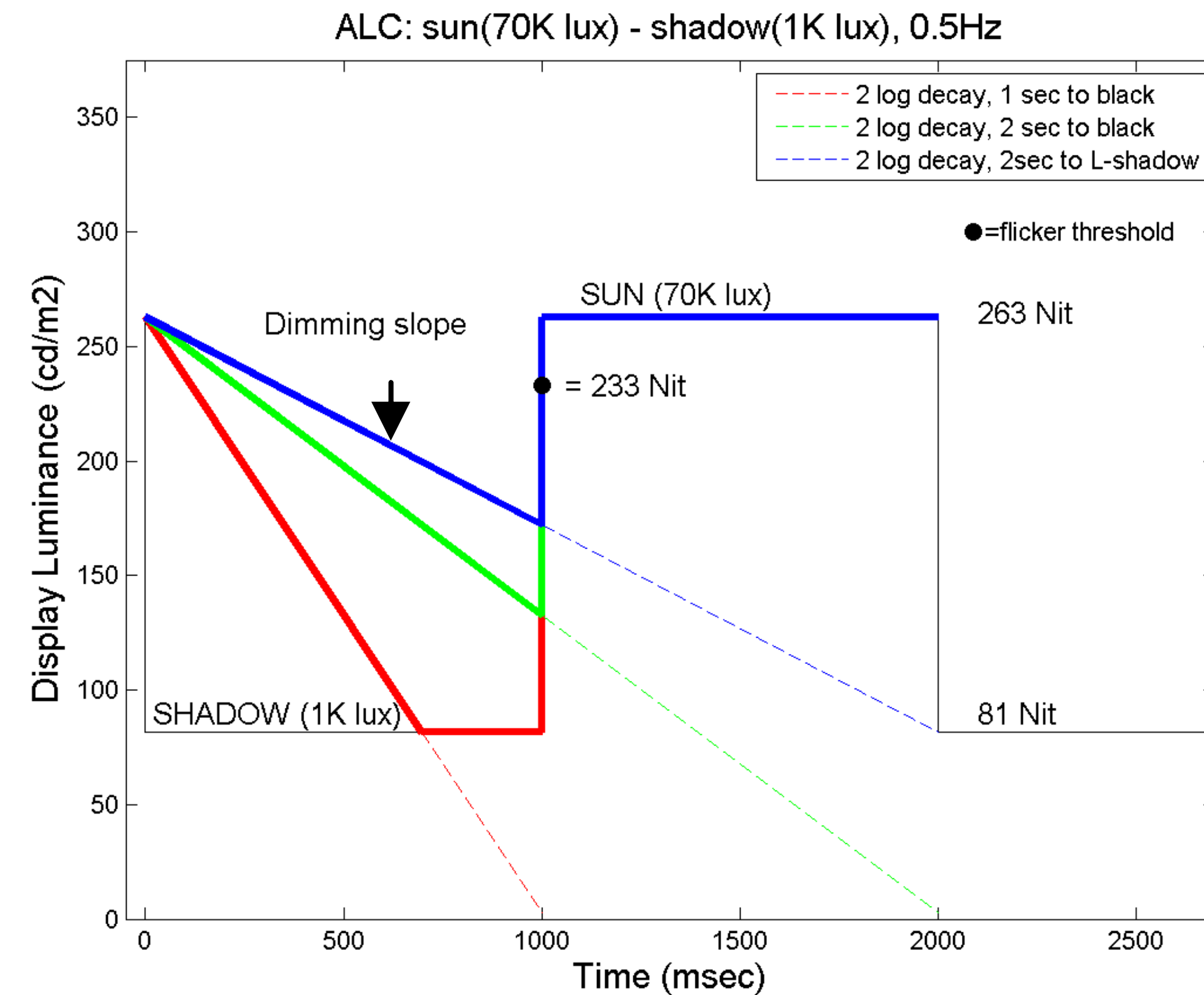
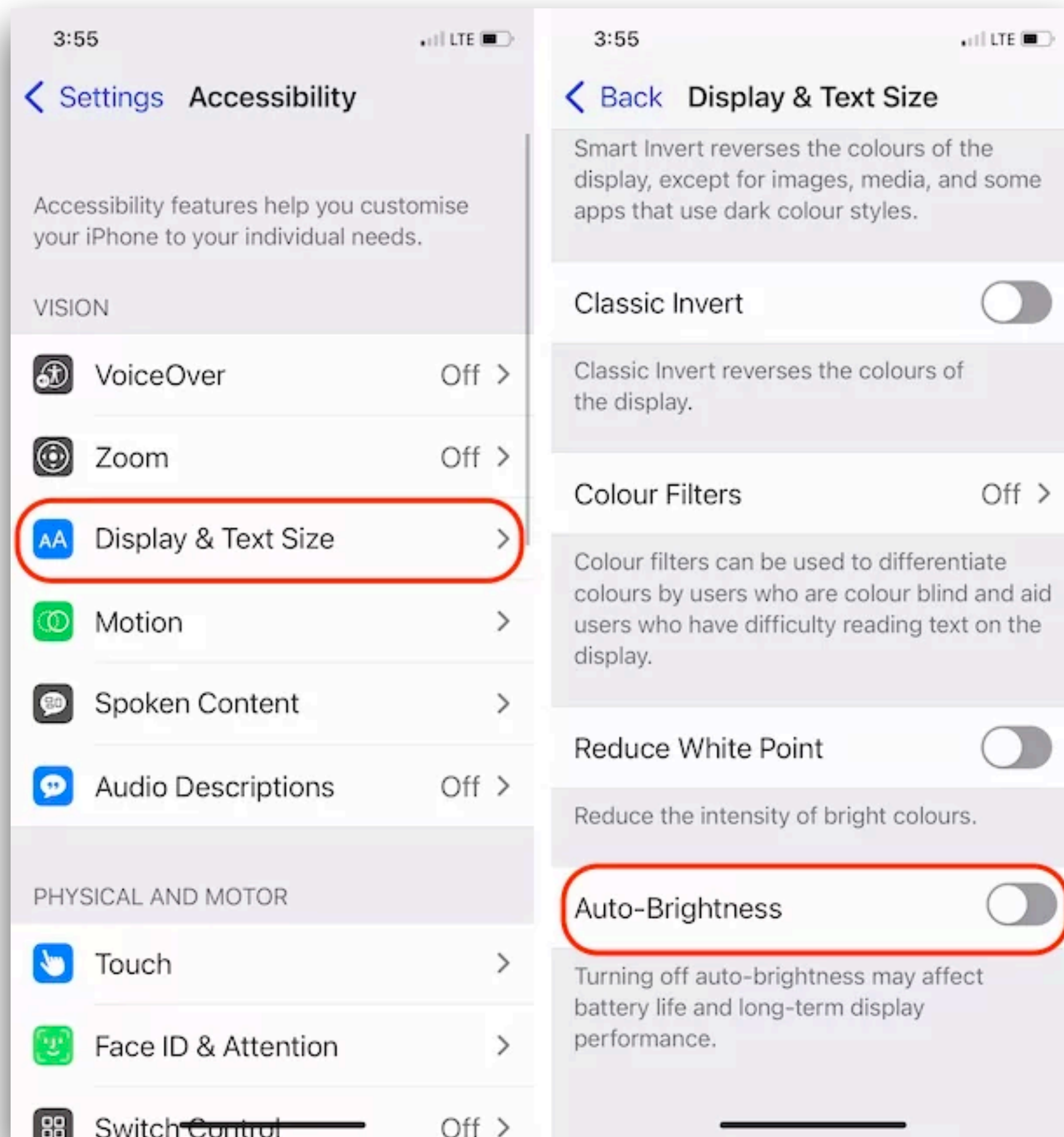

# Related: Apple TrueTone

TrueTone adjusts the white point of the display. It's related to chromatic adaption of human visual system and camera white balance. More later in the class.

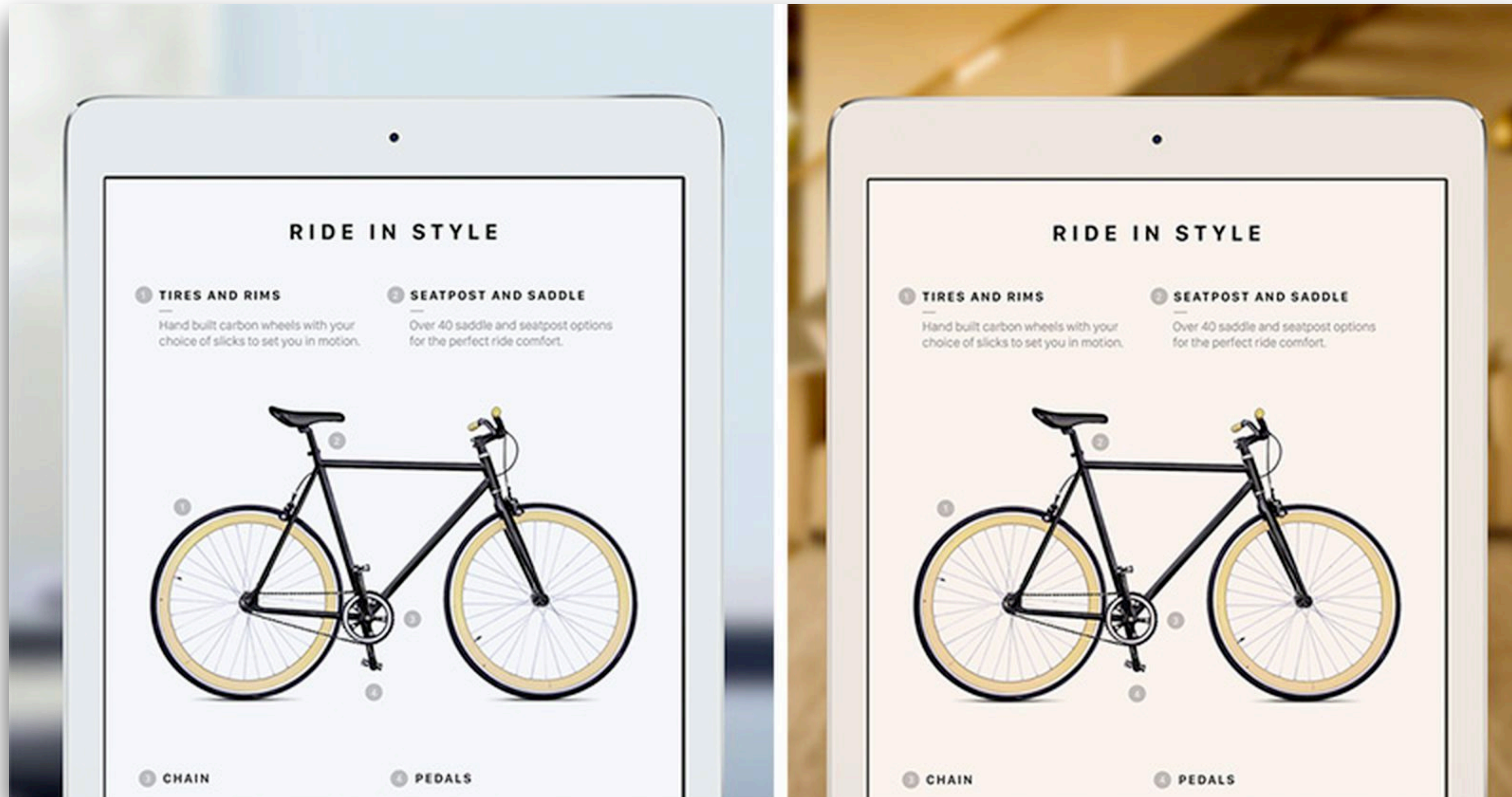

# Things to Take Away

Displays and lighting systems serve fundamentally different purposes.

- For displays we care about the color reproduction quality.
- For lighting systems we care about its “color rendering” quality.

Displays rely on metamerisms. Two main display types: LCDs and LEDs

- Low resistant displays
- Sequential color displays

Radiometry vs. Photometry